

UNIPLAN 510/310

Operating Instructions



Table of Contents

1. Application	4
1.1 Intended use	4
1.2 Non-intended use	4
1.3 General safety information	5
2. Technical Data	6
3. Transport	7
4. Your UNIPLAN 510/310	8
4.1 Type plate and identification	8
4.2 Scope of delivery (standard equipment in the case)	8
4.3 Overview of device parts	9
4.4 Power supply interruption	10
5. UNIPLAN 510 control panel	10
5.1 Overview of the UNIPLAN 510 control panel	10
5.2 Display	11
5.3 Setting the welding parameters	11
5.4 Display symbols of the status display (35)	12
5.5 Display symbols of the work display (36)	13
6. Settings and Functions of the UNIPLAN 510 Software	14
6.1 UNIPLAN 510 menu navigation overview	14
6.2 Basic setting	15
6.3 Formulas	15
6.4 Displaying set values	16
6.5 Eco mode	17
6.6 Advanced mode settings	17
6.7 Device settings	18
6.8 Info mode	20
6.9 Duty info	20
6.10 General Info	20
7. UNIPLAN 510 Commissioning	21
7.1 Work environment and safety	21
7.2 Work environment and safety	24
7.3 Welding sequence	25
7.4 Welding completion	26
7.5 Turning off the device	26

8. UNIPLAN 510 Quick Guide	27
8.1 Switching on/Starting	27
8.2 Switching off	27
9. UNIPLAN 510 Warning and Error Messages	28
10. UNIPLAN 310 Control Panel	30
10.1 Overview of the UNIPLAN 310 control panel	30
10.2 Symbols	30
10.3 LED status display	30
10.4 Setting the parameter units	31
11. UNIPLAN 310 Commissioning	32
11.1 Operating readiness	32
11.2 Starting the device	32
11.3 Setting the welding parameters	33
11.4 Welding sequence	33
11.5 Finishing welding	34
11.6 Turning off the device	34
12. UNIPLAN 310 Quick Guide	35
12.1 Switching on/Starting	35
12.2 Switching off	35
13. Warning and Error Messages, UNIPLAN 310	36
14. Maintenance of the UNIPLAN 310	36
15. UNIPLAN 510/310 FAQs, Causes and Measures	37
16. Accessories	38
17. Service and Repair	38
18. Training	38
19. Declaration of Conformity	38
20. Disposal	38

Congratulations on your purchase of the UNIPLAN 510/310.

You have chosen a first-class hot-air welder.

It was developed and produced in accordance with the very latest state of technology in the plastics-processing industry. It has also been manufactured using high-quality materials.



Please always store these operating instructions with the device.

UNIPLAN 510/310

Hot-air welder



You can find more information on the UNIPLAN 510/310 at leister.com

1. Application

1.1 Intended use

- Manually-guided hot-air welder for overlap welding, hem welding or pipe welding PVC, PE and similar materials.
- For use in well-ventilated areas.
- Welding widths: 20mm, 30mm and 40mm

The statutory health and safety regulations applicable in the country of use must be complied with. Never use the hot-air welder in explosive or readily flammable surroundings. Maintain sufficient distance from combustible materials or explosive gases at all times.

Read the material safety data sheet from the material manufacturer and follow their instructions. Be careful not to burn the material during the welding process.



- Only operate the device **under supervision** as waste heat can reach flammable materials.
- The device should only be operated by **trained specialists** or under their supervision.
- Children are not permitted to operate the device.

1.2 Non-intended use

Any other use or any use beyond the type of use described is deemed non-intended use.

1.3 General safety information

Please observe the safety instructions provided in the individual chapters of these operating instructions as well as the following safety instructions.

Warning



Risk of death from electric shock due to dangerous electrical voltage

- The device is only to be connected to sockets and extension cables with a protective earth conductor.
- Protect the device from moisture and wet conditions.
- When used on a construction site, a residual current circuit breaker is mandatory.
- Prior to using the device for the first time, check the power cord, the plug, and the extension cable for electrical and mechanical damage.
- The device may only be opened by instructed, qualified personnel.



Danger of fire and explosion with improper use in the vicinity of flammable materials and explosive gases.

- Avoid overheating of the material.
- Never place the device near combustible materials and/or explosive gases.
- Never place the device close to combustible materials and/or explosive gases while it is running and/or hot.
- Only use the device on fireproof surfaces.



Risk of burns due to hot equipment parts and hot air jet

- Do not touch the heating tube and nozzle when they are hot.
- Always allow the device to cool down first.
- Never point the hot air flow at people or animals.



Risk of injury due to improperly repaired devices



- Repairs should only be carried out by authorized service points.
- Restricted to use with original accessories and spare parts.

Caution



- The local supply **voltage** must match the nominal **voltage** specified on the device.
- If the power supply fails, switch off the unit at the main switch and swing the hot air blower into the park position, in order to avoid damage to the hot-air blower.

2. Technical Data

		UNIPLAN 310	UNIPLAN 310	UNIPLAN 510	UNIPLAN 510
Voltage	V	120	230	120	230
Frequency	Hz			50 / 60	
Power	W	1800	3450	1800	3450
Speed	m/min ft/min			1-16 3.3-52.5	
Temperature	°C °F	100-550 212-1022	100-620 212-1148	100-620 212-1148	100-620 212-1148
Blower speed	rpm	8 800	12 500	12 600	16 200
Brushless blower motor				Yes	
Brushless drive motor				Yes	
Welding nozzle	mm in			20 / 30 / 40 0.8 / 1.2 / 1.6	
Noise level	dB (A)			70 (K = dB)	
LQS				No	
Length	mm in			500 19.7	
Width	mm in			310 12.2	
Height	mm in			300 11.8	
Weight	kg lbs	15 33	15 33	16 35	16 35
Approvals, Protection class				 	
Country of origin				Switzerland	

* without **auxiliary weight (14)** and **power cord (3)**
We reserve the right to make technical changes.

3. Transport

Risk of excessive physical strain when carrying and lifting the device



- For transporting the hot-air welder use the transport box included in the scope of delivery and carry the transport box using the handle provided for the purpose.
- Comply with applicable national regulations regarding the carrying or lifting of loads.



- **Two persons are required** for transporting the machine with the transport box.



Fire hazard when transporting while hot

- The **hot air blower (9)** reaches temperatures of 620 °C.
- Allow the **hot-air blower (9)** to cool down sufficiently prior to transport (see  Cool-Down Mode [7.5]).
- Never store flammable materials (such as plastic or wood) in the transport box.



- Never use the **carrying handle (1)** on the device or on the transport box for transporting with a crane, as this may cause the unit to fall.

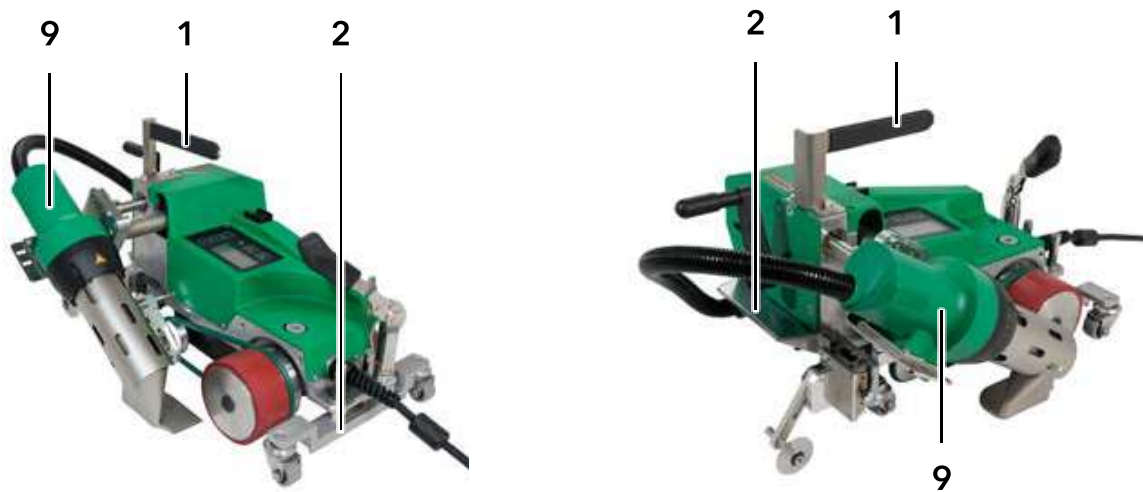

Fold in the **hot-air blower (9)** prior to transport. Use the **carrying handle (1)** or the **handles (2)** on the aluminum housing to lift the hot-air welder by hand.

4. Your UNIPLAN 510/310

4.1 Type plate and identification

The model and serial number are indicated on your device's **name plate (12)**.

Transfer this information to your operating instructions; in the event of any inquiries to our country subsidiary or your authorized Leister sales and service partner, please always refer to this information.

Model:.....
Serial no.:.....

Example:



4.2 Scope of delivery (standard equipment in the case)

UNIPLAN 310

- 1 UNIPLAN 310
- 1 Guide bar (1)
- 1 Guide wheel (17)
- 1 Safety instructions
- 1 Quick guide
- 1 Main catalog
- 1 Flat wedge (26)
- 1 Nozzle adjustment gauge (23)

UNIPLAN 510

- 1 UNIPLAN 510
- 1 Carrying handle / guide bar, short (1)
- 2 Weights: 1.25 kg each (14)
- 1 Guide wheel (17)
- 1 Material lifting device (18)
- 1 Lever screw (19)
- 1 Bracket for guide handle (20)
- 1 Weight holder base (21)
- 1 Nozzle adjustment gauge (23)
- 1 Wooden handle wire brush (24)
- 1 Safety instructions
- 1 Quick guide
- 1 Main catalog
- 1 Flat wedge (26)
- 1 Hem guide (25)

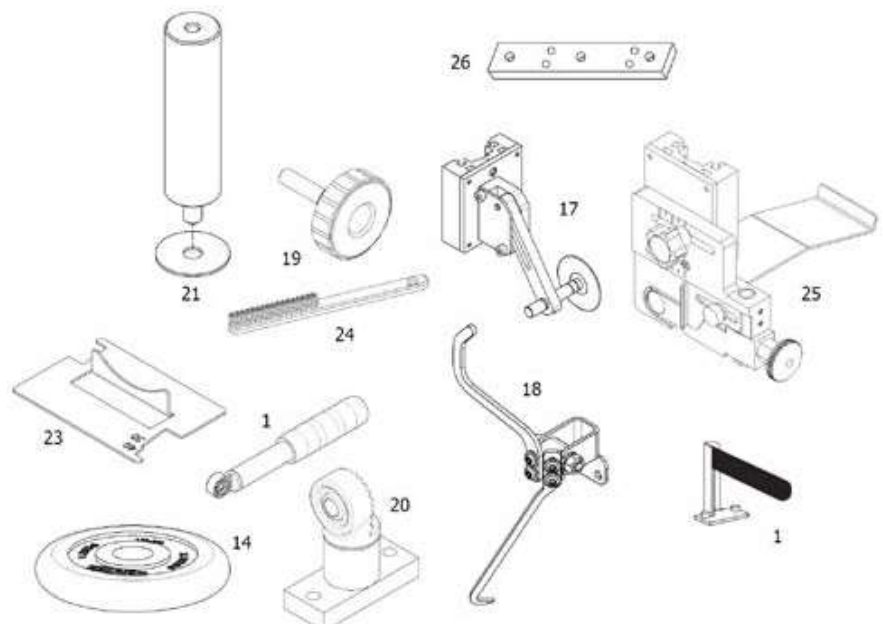

4.3 Overview of device parts

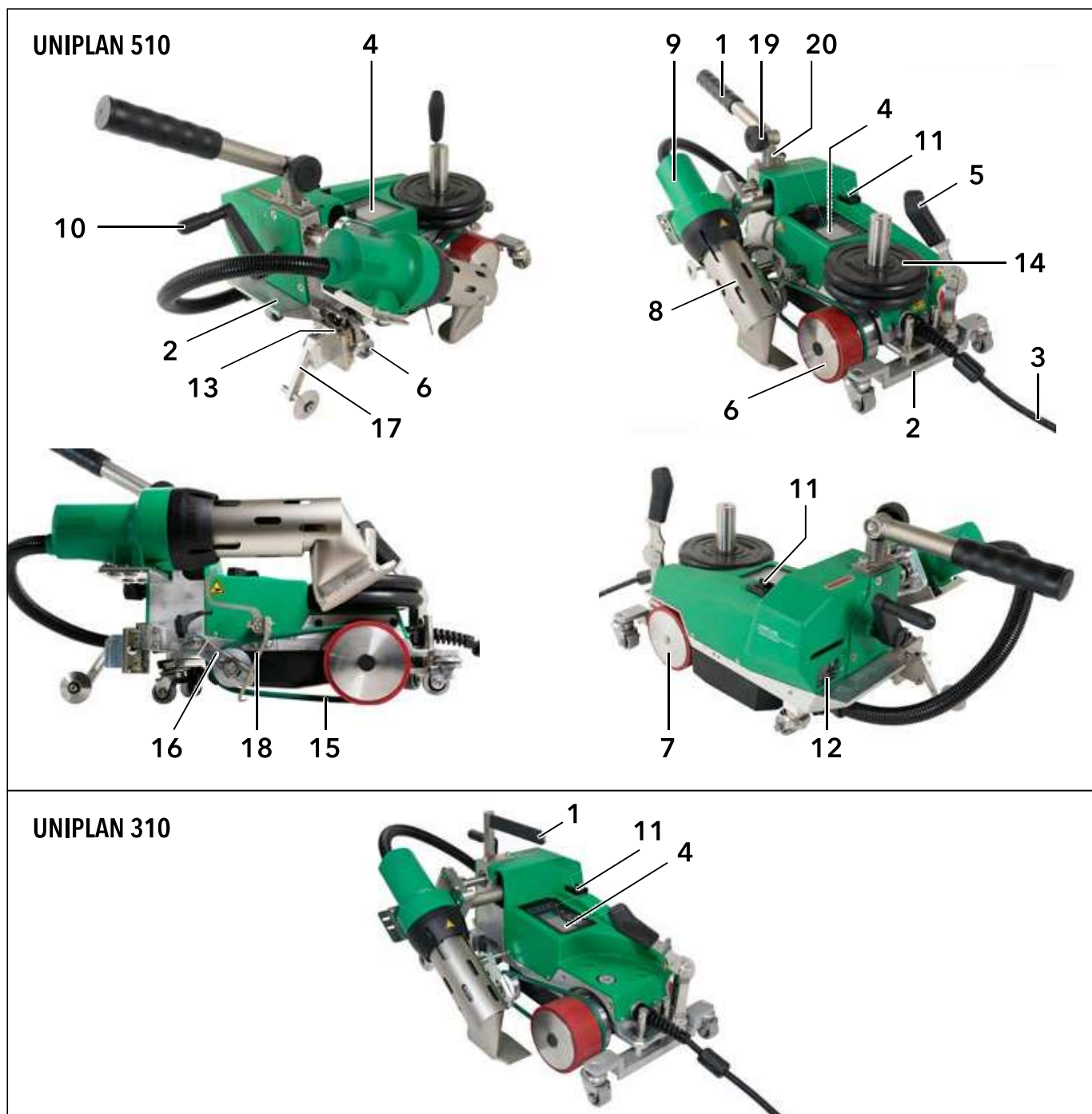

1. Carrying handle / guide bar

2. Handles

3. Power cord

4. Control panel

5. Lever for automatic material lifting

6. Drive roller / contact pressure roller

7. Support roller

8. Welding nozzle

9. Hot-air blower

10. Nozzle engagement lever

11. Main switch

12. Specification plate

13. Mounting rail for accessories

14. Auxiliary weight

15. Round belt

16. Tensioner for the round belt

17. Guide wheel

18. Material lifting device

19. Lever screw

20. Guide handle bracket

4.4 Power supply interruption



- If the power supply fails, turn off the main switch and place the hot-air blower into the park position, in order to avoid damage to the hot-air blower.

5. UNIPLAN 510 control panel

5.1 Overview of the UNIPLAN 510 control panel

Function buttons

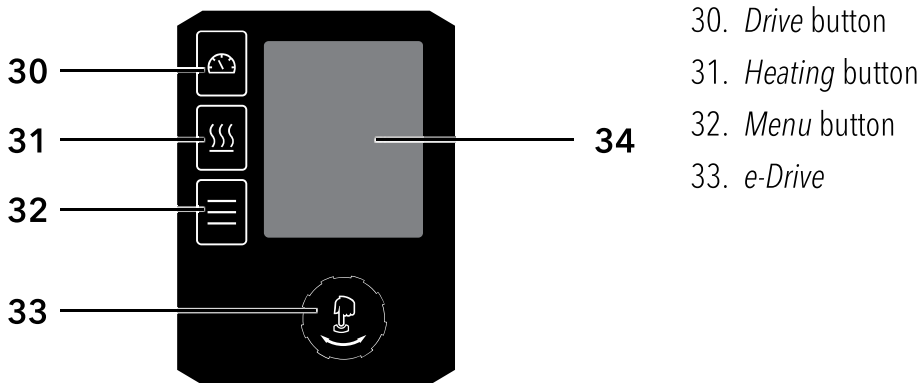

Function button Control Panel

Symbol	Name	In the work display (36)	In the menu, after pressing the button (32)
	Drive button (30)	Switch the <i>drive on/off</i>	Selection of line when editing text
	Heating button (31)	Switching heating on and off	Selection of line when editing text
	Menu button (32)	Switch to menu	return to the working display
	e-Drive (33) press	Selected value is adopted, selection goes straight back to the function display	Selects the marked position
	e-Drive (33) rotate	Sets the required setpoint in 0.1m/min, 10°C or 5% steps	Changes the position within the setup menu and sets the value of the selected position

5.2 Display

The **display (34)** is subdivided into two display areas:

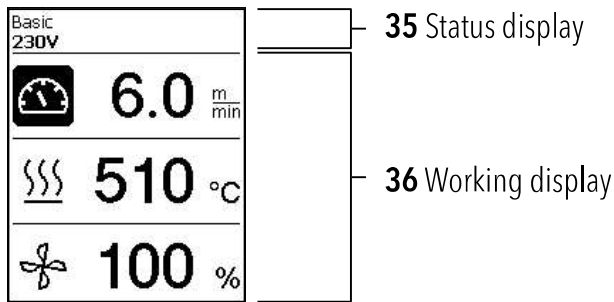

5.3 Setting the welding parameters

To adjust a welding parameter before welding, proceed as follows:

Example for setting the welding temperature

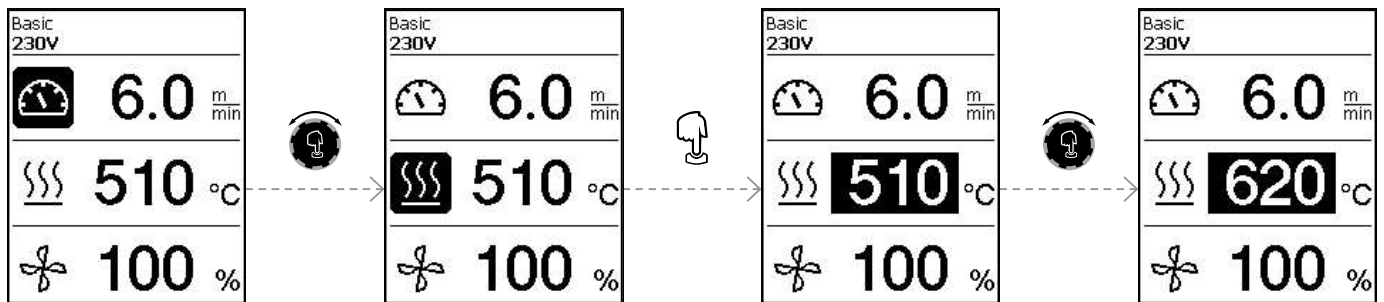

If you do not make any more entries, the cursor automatically jumps back to the temperature symbol. You can then select the next welding parameter with the *e-Drive* button (33).

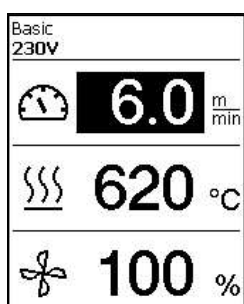

During the welding process, the cursor is always on the Drive icon. **You can adjust the welding speed at any time using the *e-Drive* button (33).**

If you want to adjust another parameter, first press the *e-Drive* button (33), then turn the *e-Drive* button (33) and select the desired parameter.

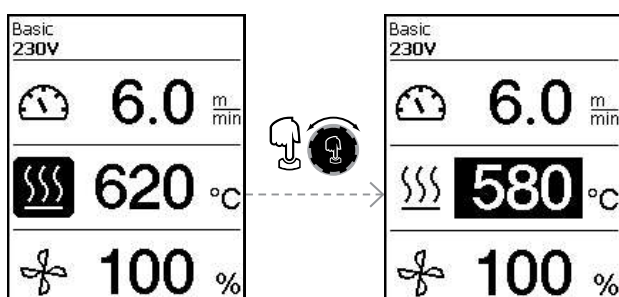

If you do not make any further entries, the cursor automatically jumps back to the Drive icon if the Info Mode is not switched on.

5.4 Display symbols of the status display (35)

The status display (35) on the **display (34)** is subdivided into a left-hand (1) and a right-hand area (2).

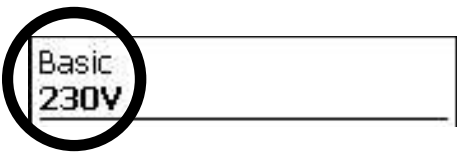
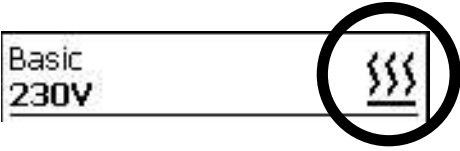
Status display 1/Left	
Profile name	Displays the name of the selected, currently valid welding profile (such as Basic). If a profile name contains more than 6 characters, the first 6 characters are shown first, followed by the remaining 6 characters. The system then presents the first 6 characters.
Voltage	Display of the supply voltage
Status display 2/Right	
Heating	Heating on/off display



Warning present



Heating



Overvoltage



Eco-Mode







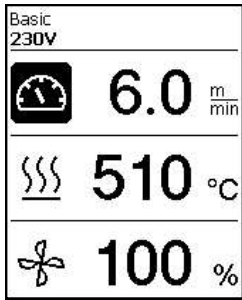



Undervoltage

5.5 Display symbols of the work display (36)

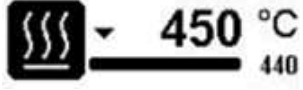

During operation, the set values of the welding parameters (drive in m/min or ft/min, temperature in degrees Celsius (°C) or Fahrenheit (°F), air volume in percent (%) and, if applicable, information notes (see  General Info [6.10]) are displayed.

You can use the *e-Drive* button (33) to switch between the welding parameters. By pressing the *e-Drive* button (33), you select the respective parameter and then adjust it individually by turning the *e-Drive* button (33).

	Symbol drive/welding speed [m/min or ft/min]
	Symbol air temperature [°C or °F]
	Symbol air volume [%]
	Welding temperature too low, heating process up arrow and progress bar show that the desired higher temperature has not yet been achieved. The flashing number above the progress bar designates the currently achieved actual value (290); the value near the right of the bar (460) shows the set value of the selected welding profile or of the individual setting.
	Welding temperature too high, cooling process down arrow and progress bar show that the desired lower temperature has not yet been achieved. The flashing value above the bar designates the currently achieved actual value (535); the value near the right of the bar (430) shows the set value of the selected welding profile or of the individual setting.
	Symbol for cool-down mode
	Symbol for hardware error warning The device is no longer ready for operation. Please contact your authorized Leister sales and service partner. Note the respective error code in Section Warning and Error Messages.
	Symbol for hardware error warning (heating element is defective). The device is no longer ready for operation. Please contact your authorized Leister sales and service partner.
	Symbol for excessive temperature warning . Allow the device to cool down.

6. Settings and Functions of the UNIPLAN 510 Software

6.1 UNIPLAN 510 menu navigation overview

Note: Pressing the *Menu* button (32)  will return you to the working display in each menu item.

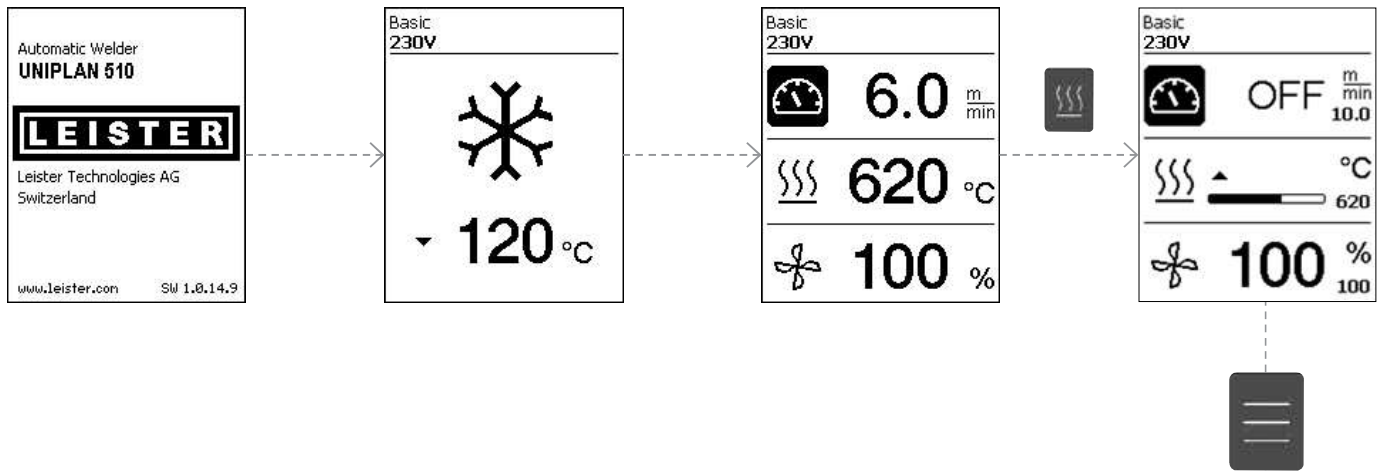

Example: Selection of recipes

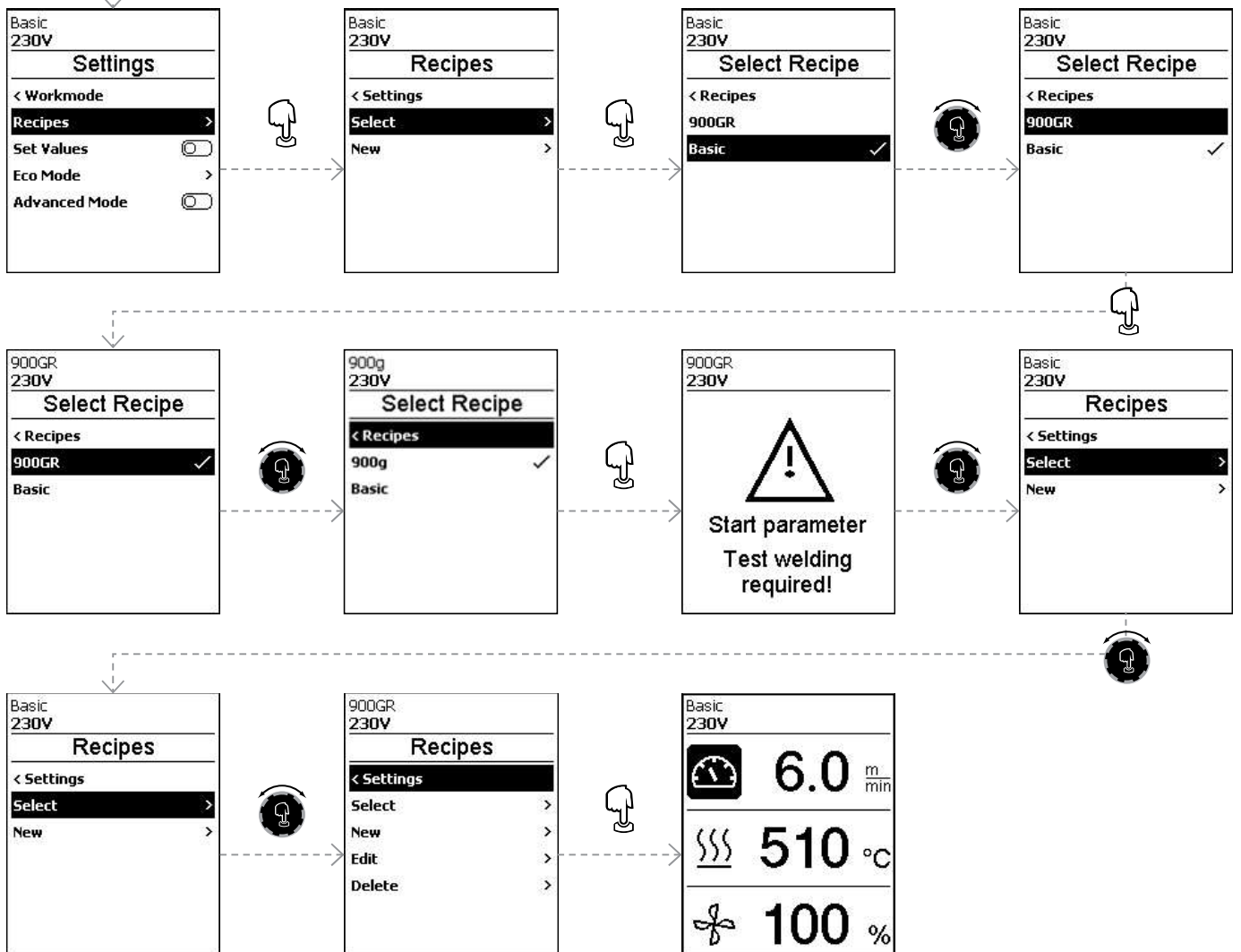

6.2 Basic setting

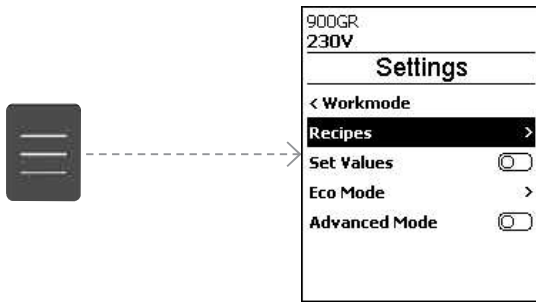

- Recipes
- Display of set values
- Eco mode
- Advanced mode

6.3 Formulas

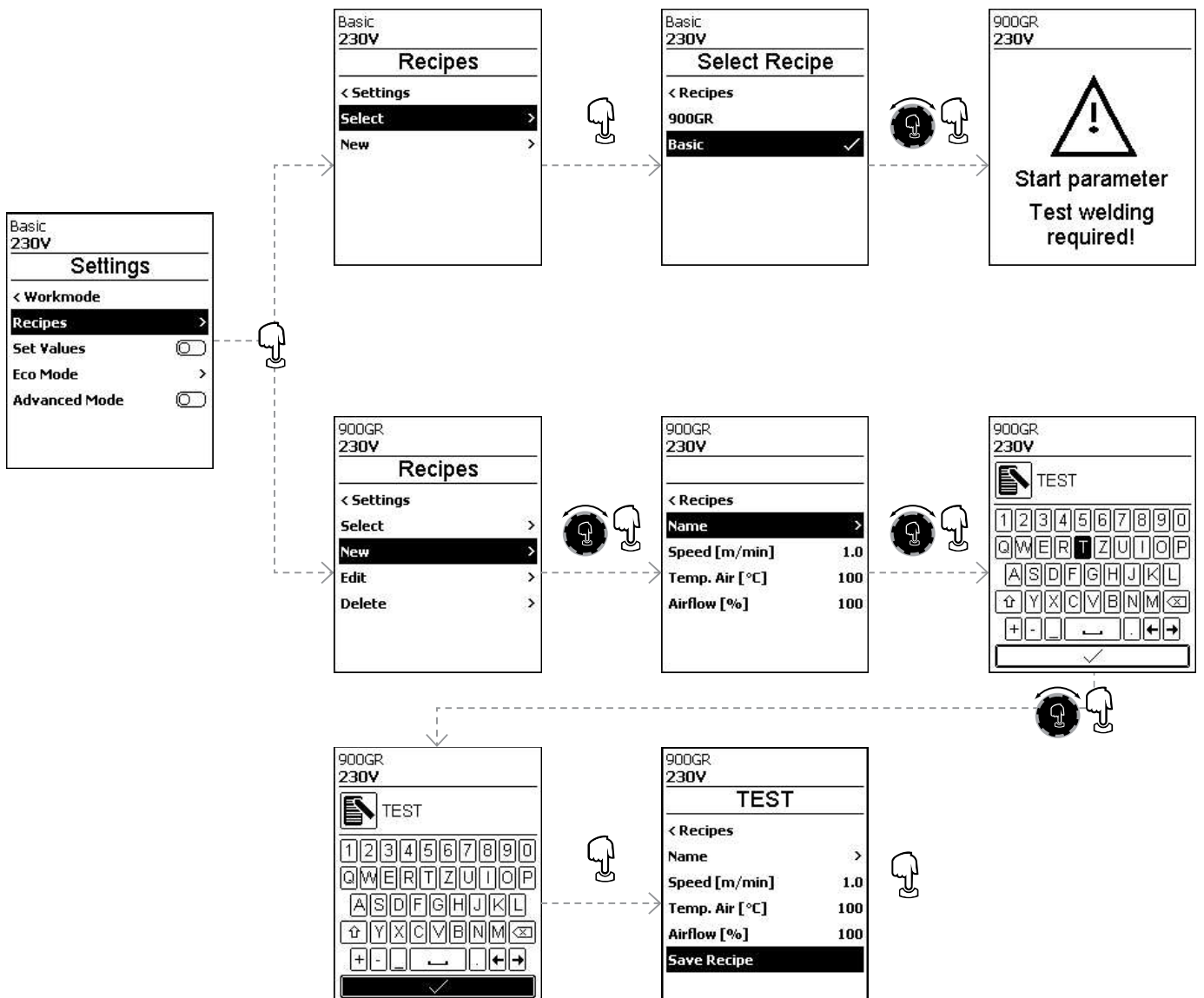

To change the parameters of the customizable recipes, proceed as follows:
 Note: All customizable recipes are displayed.

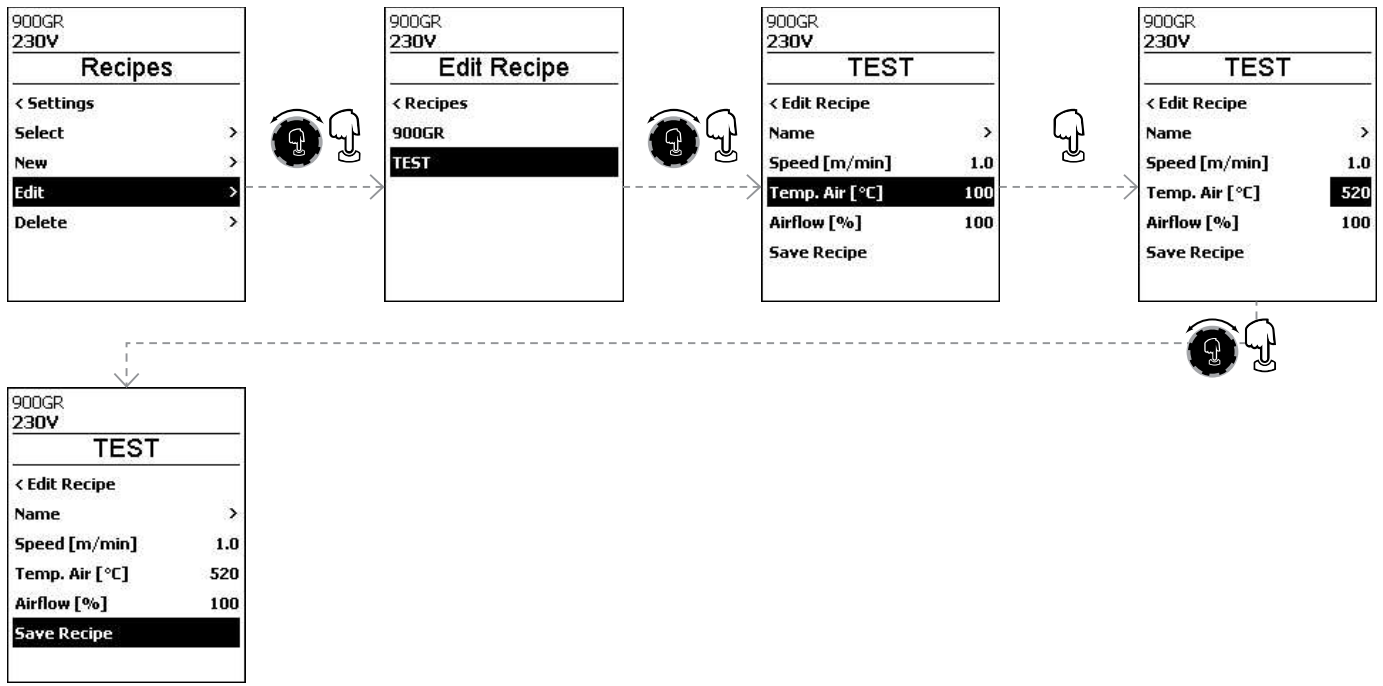

6.4 Displaying set values

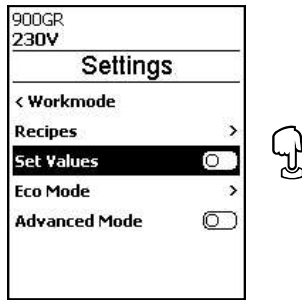

The actual value and set value display is switched on in the working display (36) at the factory.
 If no actual and set values are to be displayed in the working display (36), the Set Values can be deactivated.

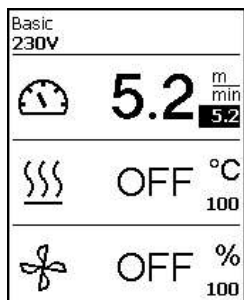

Set Values on

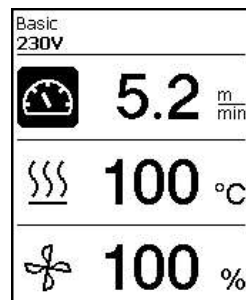

Set Values off

If the Set Values function is activated, the actual temperature (high) and the target temperature (low) are shown in the work display (36).

This applies analogously for drive (m/min) or air volume (percent).

6.5 Eco mode

The Eco-Mode function is switched off at the factory.
You can activate Eco-Mode by pressing the *e-Drive* button (33).

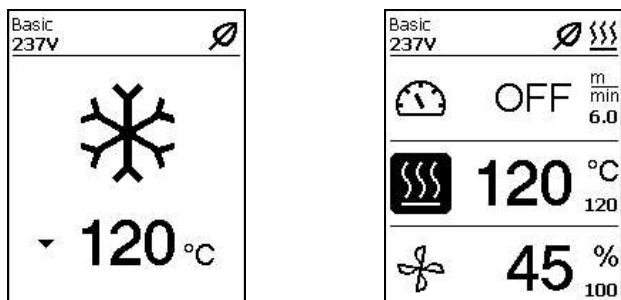
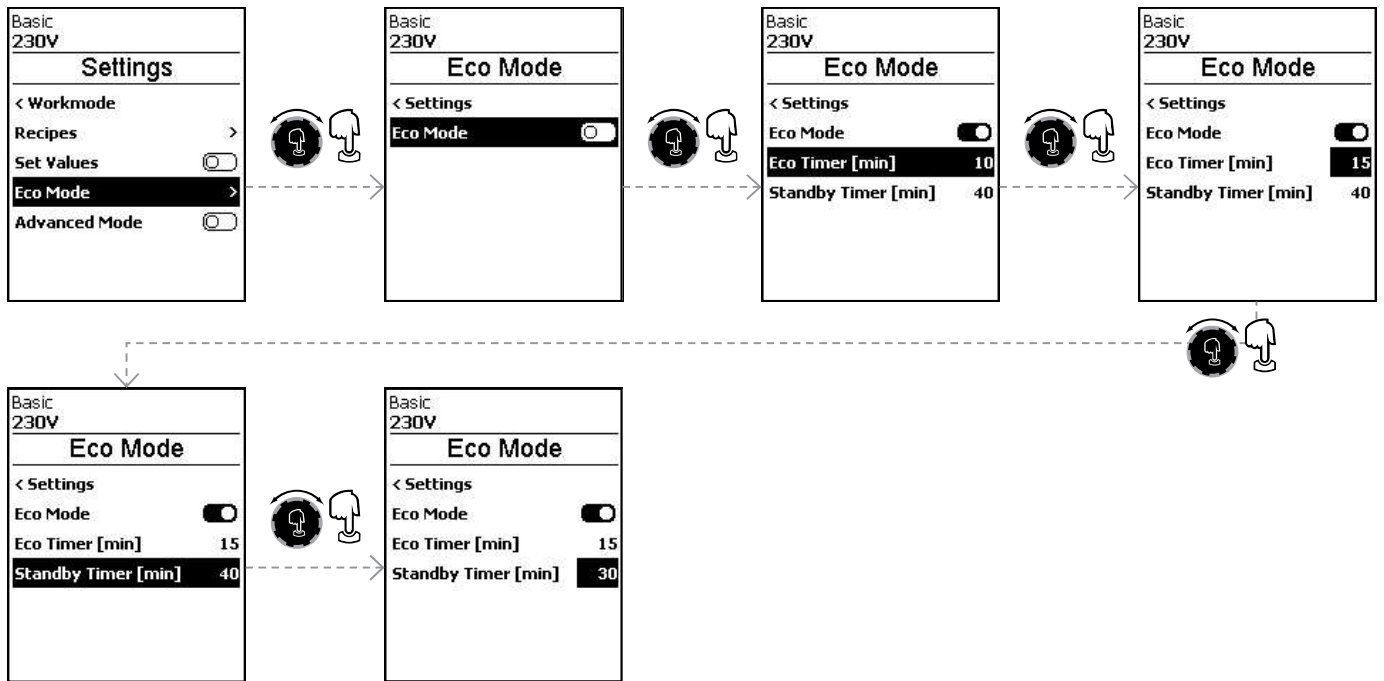

If Eco-Mode is activated and the device remains inactive (no buttons pressed for the set period of time, you will automatically switch to Eco Timer mode. The air volume is automatically reduced to 45%. In the working display (36), the Eco Timer is displayed with the corresponding symbol.

After the Standby Timer has expired without activity, the cooling process is automatically initiated. The cooling process can be interrupted with the *heating* button (31).

6.6 Advanced mode settings

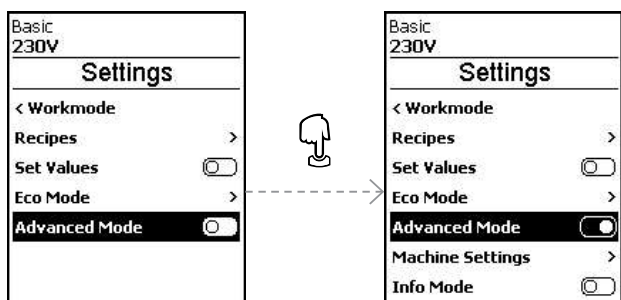

If you have activated Advanced Mode, additional menu options are available to you.

6.7 Device settings



Date & Time

Setting the hour, minute, year, month and day.

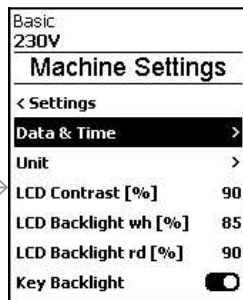
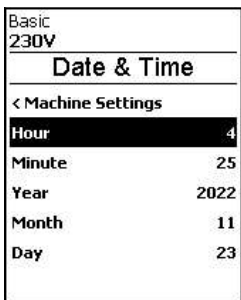

Unit

Selection of the display units; metric or imperial.

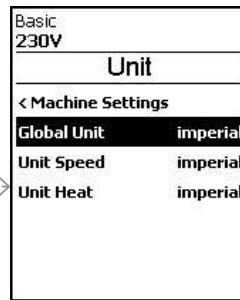
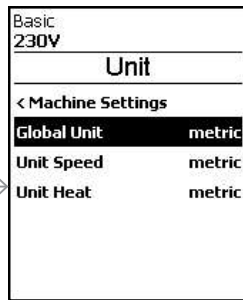
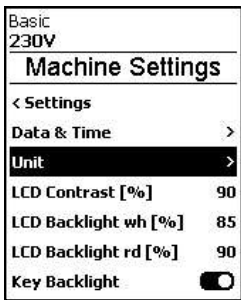

LCD Contrast

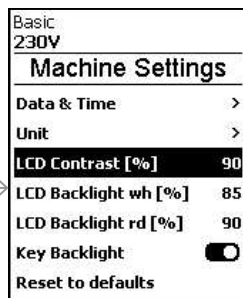
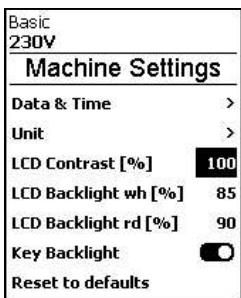

LCD Backlight (wh, rd)

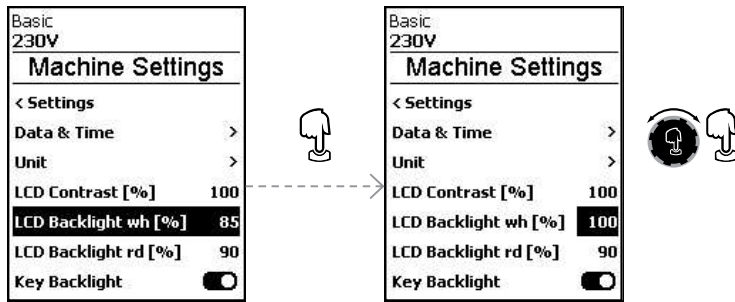

Backlight button

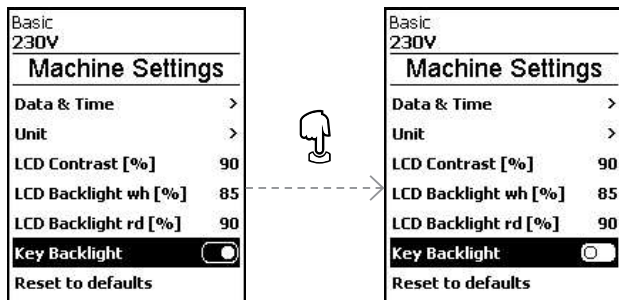

Using the Key-Backlight function you can switch the illumination of the keyboard on or off.

Reset to defaults

Activating the Reset to defaults function resets all settings to factory default.

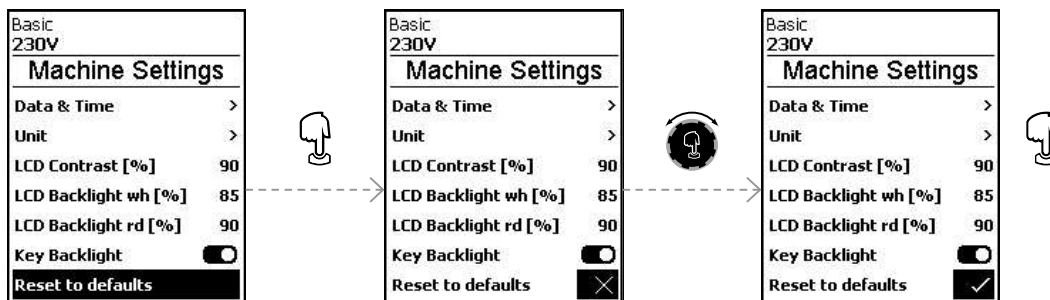

6.8 Info mode

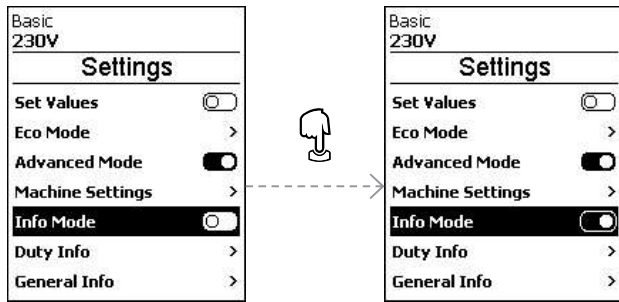

Info Mode is switched off at the factory.

If Info Mode is activated, additional information is displayed at the work level.

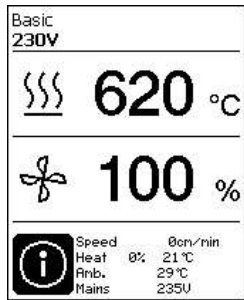

The following information is displayed:

- Speed in cm/min
- Capacity utilization of the heating output in percent as well as the temperature in °C
- Ambient temperature in °C
- Mains voltage in V

6.9 Duty info

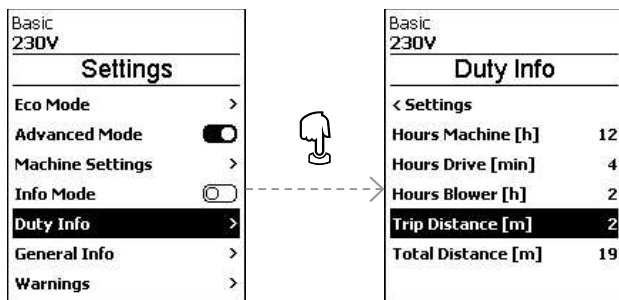

If Duty Info is activated, the runtimes of the machine, the drive and the blower are displayed.

In the two lines below, you can see the distances traveled as a day counter and as total run time.

The day counter can be deleted by you.

To delete the day counter, select the menu item Trip Distance.

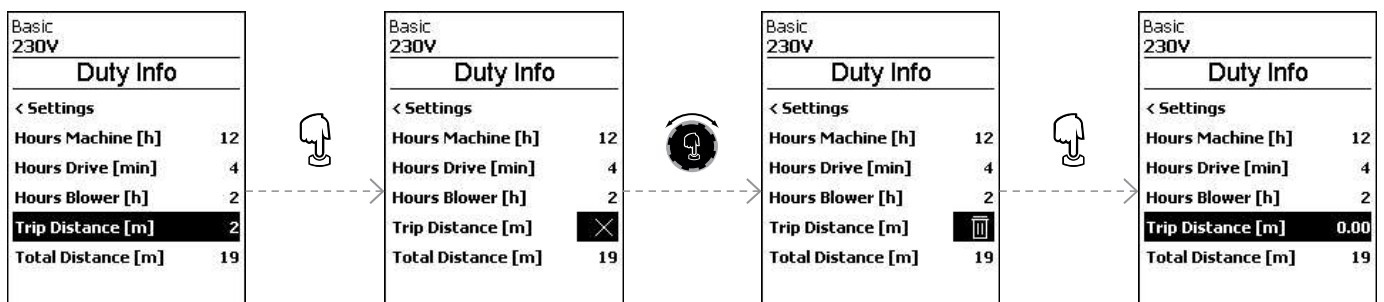

6.10 General Info

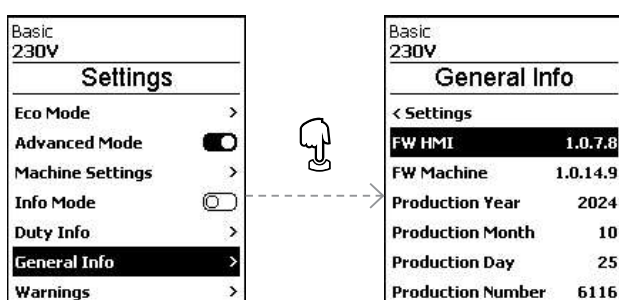

The following information is displayed:

- Software version HMI and PCU
- Production date of the machine
- Serial number

7. UNIPLAN 510 Commissioning

7.1 Work environment and safety

Safety precautions



Risk of death from electric shock due to dangerous electrical voltage

- The device is only to be connected to sockets and extension cables with a protective earth conductor.
- Protect the device from moisture and wet conditions.
- When used on a construction site, a residual current circuit breaker is mandatory.
- Prior to using the device for the first time, check the power cord, the plug, and the extension cable for electrical and mechanical damage.
- The device may only be opened by instructed, qualified personnel.



Danger of fire and explosion with improper use in the vicinity of flammable materials and explosive gases.

- Avoid overheating of the material.
- Never place the device near combustible materials and/or explosive gases.
- Never place the device close to combustible materials and/or explosive gases while it is running and/or hot.
- Only use the device on fireproof surfaces.



Risk of burns due to hot equipment parts and hot air jet

- Do not touch the heating tube and nozzle when they are hot.
- Always allow the device to cool down first.
- Never point the hot air flow at people or animals.



Risk of inadvertently becoming caught and being pulled in due to moving parts

- Do not touch any moving parts.
- Do not wear loose articles of clothing such as scarves or shawls.
- Tie up long hair and protect it with a head covering.



Risk of crushing

- Mechanically moving parts can cause hand injuries.
- Only hold on to the hot-air welder at the handles provided.



Health risk due to harmful fumes

- Welding PVC materials creates harmful hydrogen chloride vapors.
- Always ensure good ventilation of the workplace when working.
- Read the material safety data sheet from the manufacturer of the material and follow that company's instructions.
- Be careful not to burn the material during the welding process.



Risk of tripping due to power cord

- The **power cord (3)** must be able to move freely and must not hinder the user or third parties during work (trip hazard).



- The local supply **voltage** must match the nominal **voltage** specified on the device.
- If the power supply fails, switch off the unit at the main switch and swing the hot air blower into the park position, in order to avoid damage to the hot-air blower.



- In addition, comply with national statutory requirements regarding occupational safety (securing personnel and electrical devices).

Power cord and extension cable



- The nominal voltage specified on the device (see  technical data [2]) must match the supply voltage.
- The **power cord (3)** must be able to move freely and must not hinder the user or third parties during work (trip hazard).
- The extension cables must be authorized for the utilization site (such as, outdoors) and be marked accordingly. Take the necessary minimum cross-section for extension cables into account as required. Take the necessary minimum cross-section of 1.5 mm² for extension cables into account as required.

Prior to commissioning, check the **power cord (3)**, the plug, and the extension cable for electrical and mechanical damage. Damaged plugs and the extension cables must not be used, there is a risk of an electric shock.

If you are using the hot-air welder on a table, take care at all times to prevent the welder falling off the table.

If you are working on the ground and the operation will be prolonged, for ergonomic reasons we recommend the use of a long guide rod. This is available in the accessories set.

Adjusting the welding nozzle (8)

- The basic setting of the **welding nozzle (8)** is performed in the works.
- Check the basic setting of the **welding nozzle (8)**.

The setting can be checked by the **nozzle adjustment gauge (23)** or as by the measurements A and B.

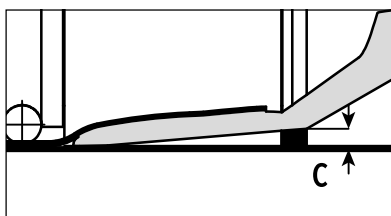
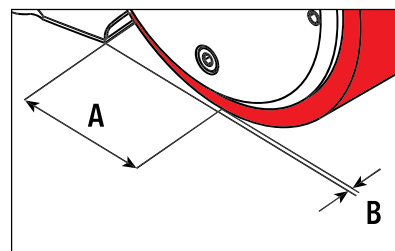
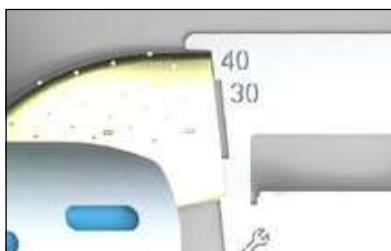

$$\begin{aligned} A &= 45 \pm 5 \text{ mm} \\ B &= 1 - 2 \text{ mm} \\ C &= 1 \text{ mm} \end{aligned}$$

Installing the guide bar (1)

- Install the **guide bar (1)** using the **lever screw (19)** and set it to the desired position

Adding an auxiliary weight (14)

- Install the **weight holder base (21)**, plus any necessary **weight holder extensions (22)**, and place the **weights (14)** on the weight holders (max. seven auxiliary weights)

Adjusting the guide wheel (17)

The roller on the **guide wheel (17)** has 4 markings

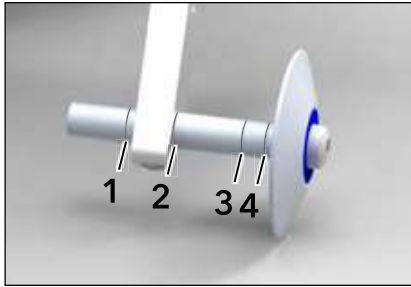

- 1: Not used
- 2: Marking 40, 30, 20 mm overlap (factory setting)
- 3: Not used
- 4: Marking tape 40 mm

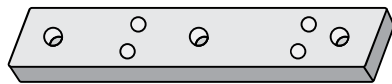

Interchangeable Wedge Options

A **flat wedge (26)**, designed to hold the rear wheels, offers enhanced mobility while moving the machine, especially during ground welding. The inclined wedge, installed by default, provides superior stability during welding. Both options are tailored to meet the specific demands of your operation.



Adjusting the starting switch

Release the **starting switch (11)** clamp, and move the starting switch as required. Moving it to the **left** increases the starting delay, moving it to the **right** reduces the starting delay. This increases or reduces the preheating time at the start up.

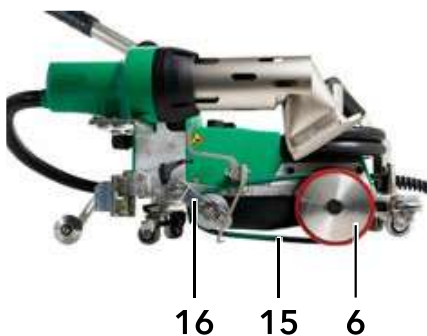

Adjusting the round belt (15)

Check the position of the **round belt (15)**. The **round belt (15)** must lie parallel to the **drive roller / contact pressure roller (6)**. If necessary, adjust the **tensioner (16)** for the round belt.

7.2 Work environment and safety



Place the **hot-air blower (9)** into the park position and connect the hot-air welder to the power supply.

Use the **main switch (11)** to turn the hot-air welder on.

After starting, the Start screen will appear briefly in the display with the version number of the current Software Release and the device designation.

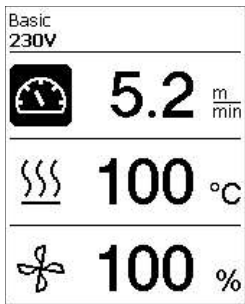

After the device has cooled down, a static display of setpoints from the most recently used profile (the Profile Basic is displayed at the time of initial commissioning of the device).

At this stage, the heating is not yet turned on!

Select the desired welding profile or define the welding parameters individually (see  Setting the parameters [5.3]).

Now turn on the heating (**Heating on/off, 31**).

Then perform test welds in accordance with the welding instructions of the material manufacturer and/or national standards or regulations, and inspect the results. Adjust the welding profile as necessary.

7.3 Welding sequence



Positioning the device

- Check that the upper and lower sides of the material to be welded are clean between the edges of the overlap.
- Then check that the **welding nozzle (8)**, the **drive roller / contact pressure roller (6)** and the **round belt (15)** are clean.
- Now use the **material lifting device (5)** to lift the hot-air welder and move the device to the desired welding position.
- Then put down the roller on the **guide wheel (17)**.
- Make sure that the roller on the **guide wheel (17)** is in line with the outer edge of the **contact pressure roller (6)**.

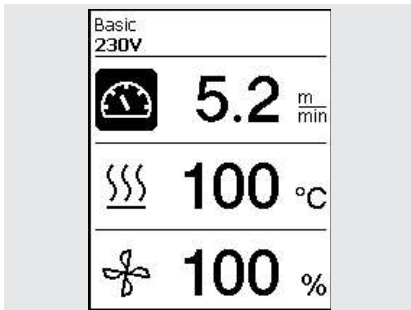

Welding Preparation

- As soon as you have turned on the heater, you will see a dynamic display of the current air temperature with progress bar (setpoint and actual values).
- Make sure that the tool has reached the appropriate welding temperature before commencing work (the heat-up time is three – five minutes).
- Now use the **material lifting device (5)** to lower the hot-air welder into the working position.
- Slightly lift the material behind the automatic welder and pull the material lifting device lever (18) towards the hot-air blower until the material rests against the lever. This ensures that the nozzle can be inserted between the two pieces of material.



Commencing welding

- Press the **lever to engage the nozzle (10)**; the **hot-air blower (9)** is lowered automatically and the welding nozzle is inserted between the two pieces of material.
- The **material lifting device (18)** is automatically activated when the nozzle is engaged and triggers the lever.
- The drive motor automatically starts as soon as the hot-air blower (9) is engaged.

You can also start the device manually with the *Drive On/Off* button (30).

Guiding the device during the welding process

Use the **guide bar (1)** or the machine housing to guide the hot-air welder along the overlap, constantly monitoring the position of the **guide wheel roller (17)**.

When welding with the hot-air welder, do not force the welder along the seam, lest this causes welding defects.

Check the parameters while welding is in progress

Welding speed, air temperature and air flow range are monitored continuously.

If an actual value deviates from a setpoint of the welding profile or the individual settings, this is shown in the **working display (36)**.

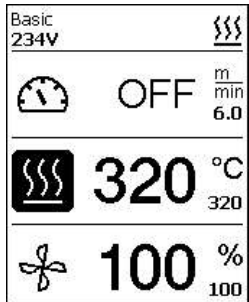

Actual value corresponds to the setpoint.

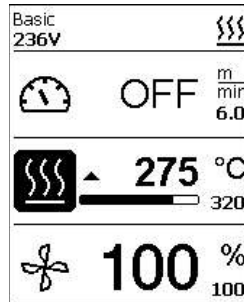

The air temperature's actual value is lower than the setpoint.

The heating up process is signaled by flashing; the arrow points upwards, the progress bar visualizes the temperature relative to the setpoint temperature value.

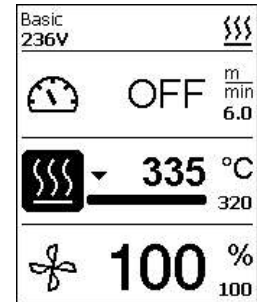

The air temperature's actual value is higher than the setpoint.

The cooling-down procedure is signaled by flashing; the arrow points downwards, the progress bar visualizes the temperature relative to the setpoint temperature value.

7.4 Welding completion

On completion of the weld, disengage the nozzle using the **lever (10)** to the stop. This retracts the **hot-air blower (9)** and stops the drive.

Then swing the **guide wheel roller (17)** upwards and use the **lifting device (5)** to lift the hot-air welder up.

7.5 Turning off the device

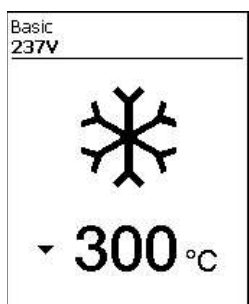

- Use the *Heating on/off* button (31) to turn off the heating.
- The device switches into cool-down mode.
- The blower switches off automatically after approx. 5 minutes.
- Now turn off the device with the **main switch (11)** and disconnect the **power supply cord (3)** from the electrical network.
- Use a **wooden handle wire brush (24)** to clean the **welding nozzle (8)**



- Wait until the device has cooled down.
- Check the **power cord (3)** and plug for electrical and/or mechanical damage. Do not use damaged mains power cables and connectors. Instead, get them repaired. There is a risk of electric shock.

8. UNIPLAN 510 Quick Guide



Observe the safety instructions and warnings in the individual sections of these operating instructions.



8.1 Switching on/Starting









1. Make sure that the **main switch (11)** is switched off and the **hot-air blowers (9)** are in parking position. Connect the plug to the mains voltage.
2. Switch the **main switch (11)** on.
3. Switch on the heating with the *heating On/Off* (31) button; wait 3–5 minutes until the desired temperature is reached.
4. Swivel the **hot-air blower (9)** downwards (appliance starts automatically).

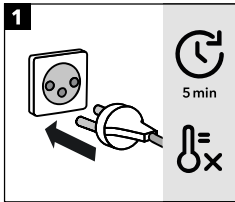

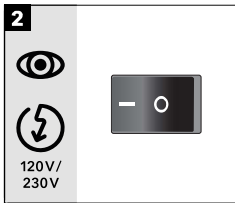
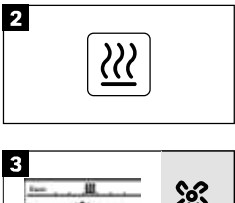
8.2 Switching off

1. Swivel the **hot-air blower (9)** upwards (stops the drive motor).
2. Use the *Heating on/off* button (31) to switch off the heating.
3. Wait for the end of the **cooling process** (approx. 6 minutes).
4. Switch off the unit at the **main switch (11)**.
5. Disconnect the **plug** from the mains voltage.

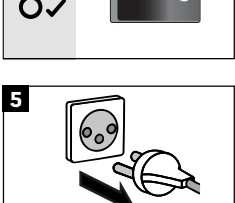
LEISTER® **UNIPLAN 510/310**
Quick Guide

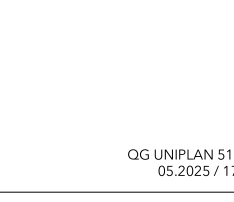

1 	1 
2 	2 
3 	3 
4 	4 
5 	5 



Operating Instructions:
leister.link/qg-uniplan-510

QG UNIPLAN 510/310
05.2025 / 179.132

9. UNIPLAN 510 Warning and Error Messages

All warnings are displayed via the Warnings function.

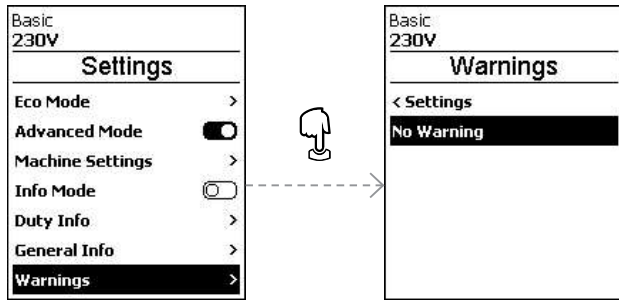



If there is a warning pending, you can still continue to work largely without restrictions.

In contrast to the warning message, it is **not possible to continue working once an error message has appeared**. The heating is switched off automatically and the drive is blocked. The display of the corresponding error codes takes proceeds without delay in the Work display (36).

You can receive specific information regarding the type of error or warning at any time, including via the menu Settings under Show Warnings.

Message type	Display	Error code	Description and measures
Warning		---	<ul style="list-style-type: none"> Example warning symbol in the status display (35). Supply voltage too high. At the same time, the red backlight of the LCD module is switched on alternately.
Error		0020	<ul style="list-style-type: none"> Error symbol and text of note (Error No. 0020/Heating element defective) in the work display. Solution: Replace the heating element

Continue to next page

Error (including address of sales and service partner, if applicable)*		0002	Undervoltage/overvoltage
		0004	Hardware error
		0008	Thermoelement is defective
		0100	Blower is faulty
		0200	Communication module error
		0400	Drive error
Contact *Leister Sales and Service Partners			



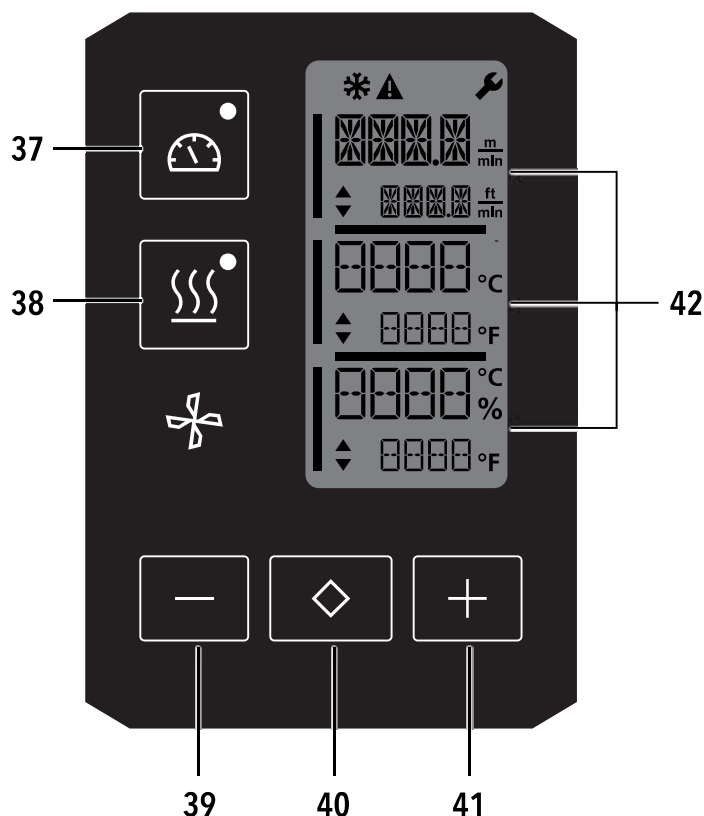

10. UNIPLAN 310 Control Panel

10.1 Overview of the UNIPLAN 310 control panel



- 37. Drive On/Off button with LED status display
- 38. Heating On/Off button with LED status display
- 39. Minus button
- 40. Confirm button
- 41. Plus button
- 42. Display fields
The actual values are displayed in large font and the setpoint values in small font. The cursor is located on the left-hand side and the parameter unit on the right-hand side.

10.2 Symbols

Symbol	Meaning
	Cool down mode Symbol for the cool-down process
	Warning message and error message See the  Chapter Warning and error messages (UNIPLAN 310) [13]
	Maintenance See the  Chapter Maintenance (UNIPLAN 310) [14]

10.3 LED status display

Heating

The LED display on the *Heating On/Off* button (38) shows the respective condition of the heating.

LED status <i>Heating On/Off</i> (38)	Condition
LED off	Heating is turned off.
LED flashes green	Heating is turned on. Temperature is outside the tolerance range.
LED continuously green	Heating is turned on. Temperature is within the tolerance range.

Drive

The LED display on the *Drive On/Off* button (37) shows the condition of the drive.

LED status <i>Drive On/Off</i> (37)	Condition
LED display off	Drive is turned off
LED display continuously green	Drive is turned on

Heating and drive

If the two LED displays for the *heating On/Off* (38) button and the *Drive On/Off* (37) button flash simultaneously, an error is active (see  Chapter Warning messages and error messages (UNIPLAN 310) 28 [13]).

10.4 Setting the parameter units

The units for the welding speed and for the temperature can be adjusted.

Temperature: °C or °F

Speed: $\frac{\text{m}}{\text{min}}$ or $\frac{\text{ft}}{\text{min}}$

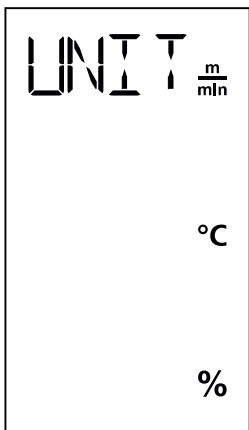

Hold down the *Drive On/Off* (37) and *heating On/Off* (38) buttons and turn on the device using the **main switch (11)**. "UNIT" then appears on the display.

Press the *Confirm* button (40) to confirm and use the *Plus/Minus* buttons (39/41) to set the desired units.

Press the *Confirm* button (40) to confirm and use the *Plus* button (41) to select "SAVE". Press the *Confirm* button (40) to confirm; the units are then saved.

The device then restarts automatically.

11. UNIPLAN 310 Commissioning

11.1 Operating readiness

Prior to commissioning, check the **power cord (3)**, the plug, and the extension cable for electrical and mechanical damage. Damaged plugs and the extension cables must not be used, due to risk of an electric shock. If you are using the hot-air welder on a table, take care at all times to prevent the welder from falling off the table. If the operation will be prolonged, we recommend the use of a guide bar. The accessories set contains a short guide bar (working on a table) and a long guide bar (working on the ground).

Adjusting the welding nozzle (8)

See  Chapter 7.1

Adjusting the guide wheel (17)

See  Chapter 7.1

Adjusting the starting switch

See  Chapter 7.1

Adjusting the round belt (15)

See  Chapter 7.1

11.2 Starting the device

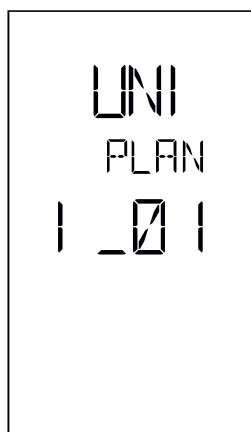

Connect the device to an **outlet with a protective conductor**. Any interruption of the protective conductor inside or outside of the device is not permitted. Only use extension cables with protective conductors.



The local supply voltage must match the nominal voltage specified on the device. If the power supply fails, turn off the **main switch (11)** and place the **hot-air blower (9)** into the park position, in order to avoid damage.



If the device is being used on job sites, a residual-current circuit breaker must be used to protect site personnel.

- Once you have prepared the working area and the hot air welder in accordance with the description, use the **main switch (11)** to turn the hot-air welder on.
- After starting, the Start screen will appear briefly in the display with the version number of the current software release and the device designation.
- If the device had cooled down beforehand, this will be followed by a static display of the setpoints
- **At this stage, the heating is not yet turned on**

11.3 Setting the welding parameters

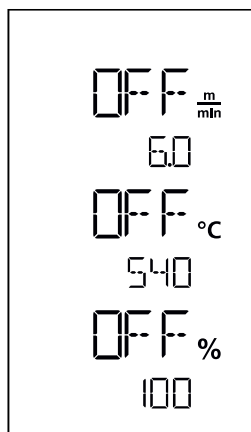

If the drive is switched off, then the welding parameters for temperature, air volume, and speed are set as follows in the **display fields (42)**:

Using the *Confirm* button (40), you can move the cursor to the desired parameter. Use the *Plus / Minus* buttons (39/41) to set the value of the selected parameter.

When the drive is switched on, the welding parameters are set in the same way and transferred immediately. The cursor automatically switches back to the drive speed row 5 seconds after the entry has been made.

11.4 Welding sequence

Welding preparation

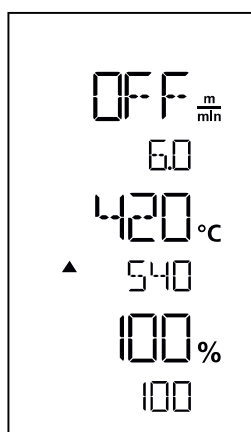

- As soon as you have turned on the heating, you will see a dynamic display of the current air temperature (setpoints and actual values).
- Make sure that the welding temperature has been reached before commencing work (the heat-up time is three – five minutes).
- Slightly fold the top piece of material behind the contact pressure roller. This ensures that the nozzle can be inserted between the two pieces of material.

Commencing welding

- Rotate the lever to engage the **nozzle (10)**; the **hot-air blower (9)** is lowered automatically and the welding nozzle is inserted between the two pieces of material.
- The drive motor automatically starts as soon as the **hot-air blower (9)** is engaged.

You can also start the device manually with the *Drive On/Off* button (37).

Guiding the device during the welding process

Use the **guide bar (1) or housing** to guide the hot-air welder along the overlap, constantly monitoring the position of the **guide wheel roller (17)**.

When welding with the hot-air welder, do not force the welder along the seam, lest this causes welding defects.

Check the parameters whilst welding is in progress

Welding speed, air temperature and air flow range are monitored continuously. If an actual value deviates from the selected settings, this will be shown in the **Work display (42)**.

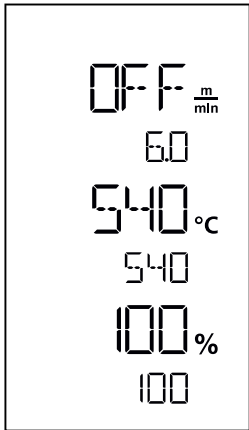

Actual value corresponds to the setpoint.

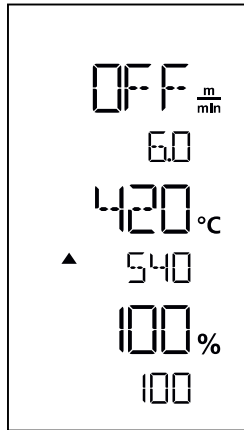

The air temperature actual value is lower than the setpoint. The heat-up process is signaled by flashing; the arrow is pointing upwards.

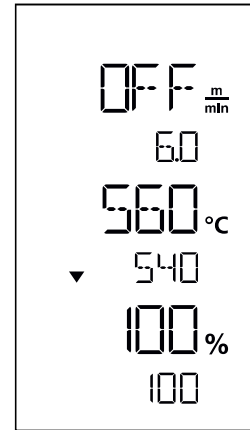

The air temperature actual value is higher than the setpoint. The cool-down process is signaled by flashing; the arrow is pointing downwards.

11.5 Finishing welding

Once welding has been completed, remove the nozzle, using the **lever (10)**. This will retract the **hot-air blower (9)** and stop the drive.

Then place the **guide wheel roller (17)** in the upwards position and use the **lifting device (5)** to remove the hot-air welder from the ground.

11.6 Turning off the device

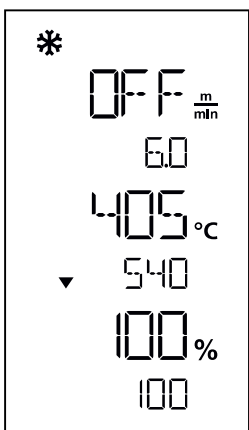

Use the *heating on/off* button (38) to turn off the heating. The device switches to cool down mode and the blower switches off automatically after approx. five minutes.

Now turn off the device with the **main switch (11)** and disconnect the **power supply cord (3)** from the electrical network.



- Wait until the device has cooled down.
- Check the **power cord (3)** and plug for electrical and/or mechanical damage. Do not use damaged mains power cables and connectors. Instead, get them repaired. There is a risk of electric shock.
- Use a **wooden handle wire brush (24)** to clean the **welding nozzle (8)**

12. UNIPLAN 310 Quick Guide



Observe the safety instructions and warnings in the individual sections of these operating instructions.

12.1 Switching on/Starting



1. Make sure that the **main switch (11)** is switched off and the **hot-air blowers (9)** are in parking position. Connect the plug to the mains voltage.
2. Switch the **main switch (11)** on.
3. Switch on the heating with the *heating On/Off* (38) button; wait 3–5 minutes until the desired temperature is reached.
4. Swivel the **hot-air blower (9)** downwards (appliance starts automatically).







12.2 Switching off

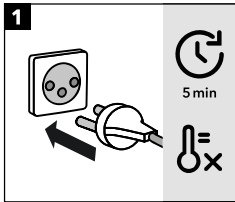

1. Swivel the **hot-air blower (9)** upwards (stops the drive motor).
2. Use the *Heating on/off* button (38) to switch off the heating.
3. Wait for the end of the **cooling process** (approx. 6 minutes).
4. Switch off the unit at the **main switch (11)**.
5. Disconnect the **plug** from the mains voltage.

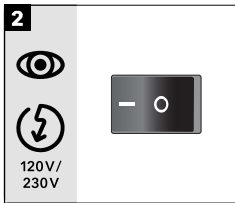
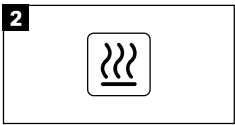
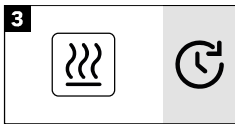
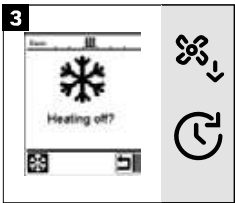
LEISTER®

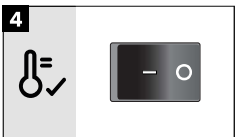
UNIPLAN 510/310
Quick Guide

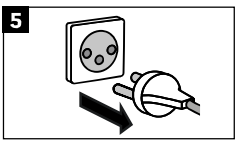

1 	1 
2 	2 
3 	3 
4 	4 
5 	5 



Operating Instructions:
leister.link/qg-uniplan-510

QG UNIPLAN 510/310
05.2025 / 179.132

13. Warning and Error Messages, UNIPLAN 310

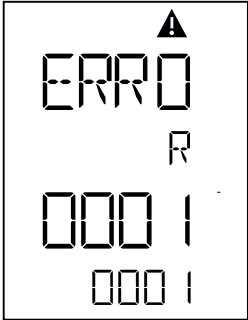
Type of message	Display	Error code / Warning message	Description
Error		0001	Device has overheated Solution: Let the device cool down
		0004	Hardware error
		0008	Thermocouple is defective
		0400	Drive error

14. Maintenance of the UNIPLAN 310

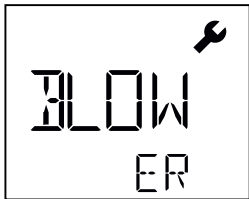

When the maintenance interval for the device is reached, the start display will show "BLOWER" or "DRIVE". The display disappears automatically after 10 seconds, or can be acknowledged by pressing *Confirm* button (40). You must take the device to your service center.

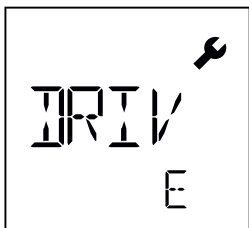

15. UNIPLAN 510/310 FAQs, Causes and Measures

The machine turns on automatically after the blowers have been turned on:

- If the air temperature is more than 100°C when the device is turned on, the device switches automatically to Cool-Down mode. The cool-down process is finished when the air temperature is less than 100°C for 2 minutes.

The machine turns off automatically:

- In Standby mode, the heating is switched off automatically after the time elapses that the user has stored (see also Standby mode). This feature is available only on the UNIPLAN 510.

Deficient welding result quality:

- Check drive speed, welding temperature and air flow range.
- Clean the **welding nozzle (9)** with wire brush (see Maintenance).
- **Welding nozzle (9)** incorrectly adjusted (see Adjust welding nozzle).

If the set welding temperature has not been reached after five minutes:

- Check the supply voltage
- Reduce the air volume

Changing the weld width:

- Please contact your local distributor for further information on changing the weld width.

16. Accessories

For more information please visit leister.com.

17. Service and Repair

Repairs shall be performed exclusively by authorized Leister sales and service partners. You will find the address of your authorized Leister sales and service partner on the last page of these operating instructions.

For more information please visit leister.com.

18. Training

The Leister Academy and its authorised Leister sales and service partners offer welding courses as well as product and application training.

For more information please visit leister.com.

19. Declaration of Conformity

Leister Technologies AG, Galileo-Strasse 10, 6056 Kaegiswil, Switzerland confirms that this product in the model made available for purchase, fulfills the requirements of the following EU directives.

Directives: 2006/42/EC, 2014/30/EU, 2011/65/EU

Harmonized EN ISO 12100, EN 60335-1, EN 60335-2-45, EN 62233, EN 55014-1, EN 55014-2,

Standards: EN 61000-3-2, EN 61000-3-3, EN 61000-6-2, EN IEC 63000

Kaegiswil, 04/29/2025

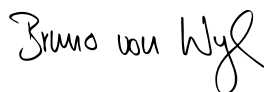

Bruno von Wyl, CTO



Pascal Bösch, VP R&D

20. Disposal



Do not dispose of electrical equipment with household refuse!

Electrical equipment, accessories and packaging should be recycled in an environmentally friendly manner. When you are disposing of our products, please observe the national and local regulations.

Warranty

- The guarantee or warranty rights granted for this device by the direct distribution partner/salesperson apply from the date of purchase. In the event of a guarantee or warranty claim (verification by invoice or delivery note), manufacturing or processing errors will be rectified by the sales partner through replacement delivery or repair. Heating elements are excluded from warranty obligations or guarantees.
- Other guarantee or warranty claims are excluded within the framework of mandatory law.
- Damage resulting from natural wear, overload, or improper handling is excluded from the warranty.
- Devices that have been converted or modified by the purchaser are not covered by any warranty or guarantee.
- Only use original Leister spare parts and accessories; otherwise, any warranty or guarantee claims will be invalidated.



Find a dealer nearby



Leister Technologies AG

Galileo-Strasse 10

6056 Kaegiswil

Switzerland

+41 41 662 74 74

leister@leister.com

leister.com

