

PENWELD A



PENWELD S



Leister Technologies AG

Galileo-Strasse 10
6056 Kaegiswil
Switzerland

+41 41 662 74 74
leister@leister.com

leister.com

Table of Contents

1. Important Safety Instructions	3
2. Application	4
1.1 Intended use	4
1.2 Non-intended use	4
3. Technical Data	5
4. Dimensions	6
4.1 Terminal box	6
4.2 PENWELD 305 A/S	6
4.3 PENWELD 500 A/S (505-A)	6
5. Your PENWELD	7
5.1 Type plate and identification	7
5.2 Overview of device parts	8
6. Using PENWELD For the First Time	9
6.1 Air supply	10
6.2 Install nozzle*	10
7. Operating the PENWELD S	11
7.1 Turning on the PENWELD S	11
7.2 Turning off the PENWELD S	11
8. Operating the PENWELD A	12
8.1 Display icons	12
8.2 Turning on the PENWELD A	12
8.3 Key lock ON/OFF	13
8.4 Turning off the PENWELD A	13
8.5 Configuration Setup Menu PENWELD A	14
9. Warnings and Error Messages PENWELD A	15
10. Maintenance	16
10.1 General maintenance instructions	16
10.2 Heating element change	17
11. Declaration of Conformity	18
12. Disposal	18

Operating Instructions (Translation of the Original User Manual)

Congratulations on purchasing your PENWELD.

You have chosen a first-class hot-air welding device.

It was developed and produced in accordance with the latest technology in the plastics-processing industry.

It has also been manufactured using high-quality materials.



Please always store these operating instructions with the device.

PENWELD

External Air-Operated Hot-Air Welder

You can find more information on the PENWELD at leister.com



1. Important Safety Instructions

Warning



Risk of death from electric shock due to dangerous electrical voltage

- The device is only to be connected to sockets and extension cables with a protective earth conductor.
- Protect the device from moisture and wet conditions.
- When used on a construction site, a residual current circuit breaker is mandatory.
- Prior to using the device for the first time, check the power cord, the plug, and the extension cable for electrical and mechanical damage.
- Pull the mains plug from the outlet before opening the device.



Danger of fire and explosion with improper installation and use

- Avoid overheating of the material.
- Never place the device near combustible materials and/or explosive gases.
- Never place the device close to combustible materials and/or explosive gases while it is running and/or hot.
- Secure the device in resting position against falling/rolling.



Risk of burns due to hot equipment parts and hot air jet

- Do not touch the heating tube and nozzle when they are hot. The device should always be allowed to cool down first.
- Never point the hot air flow at people and/or animals.

Caution



Ensure that the local supply **voltage** matches the nominal **voltage** specified on the device.



Only operate the device **under supervision**. Waste heat can come into contact with nearby flammable materials.

The device should only be operated by **trained specialists** or under their supervision. Children are not permitted to operate the device.

2. Application

1.1 Intended use

The PENWELD external air-operated hot-air welder is always equipped with an air source (e.g. AIRSTREAM ST or AIRSTREAM 100 from Leister – for requirements/limit values, see Chapter 3).









Applications:

- **Welding, shrinking and deforming** of plastics
- **Drying** of aqueous-moist surfaces
- **Shrinking** of heat shrink hoses, films, tapes, soldering connectors and molded parts
- **Soldering** of copper pipes, soldering connectors and metal foils
- **Activating** and **dissolving** solvent-free adhesives
- **Removing** plastic press burrs

1.2 Non-intended use

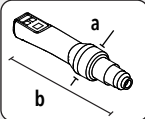
Any other use or any use beyond the type of use described is deemed non-intended use.

3. Technical Data

			PENWELD 305-S		PENWELD 305-A		PENWELD 500-S		PENWELD 500-A (505-A)	
	Voltage	V~	120	230	120	230	120	230	120	230
	Power	W	1000				1550			
	Frequency	Hz	50/60							
	Temperature	°C	60-450*				60-600*			
		°F	140-840*				140-1110*			
	min. Supply air temperature	°C	0				0			
	air temperature	°F	32				32			
	max. Supply air temperature	°C	65				65			
	°F	149				149				
	Supply air volume	min l/min	60***				80			
	max. Air pressure	bar	0.5				0.5			
psi		7.0				7.0				
	Noise level	L_{PA} (dB)	<68 dB (K = 3 dB)**				<68 dB (K = 3 dB)**			
	Weight (without power cord)	kg	0.41	0.43	0.46	0.48				
lbs		0.9	0.94	1.01	1.05					
	Weight (not inc. welding shoe)	a) Ø mm	54				54			
		Ø inch	2.1				2.1			
		b) mm	254				275 (281)			
		inches	10				10.8 (11.1)			
										

Subject to change without prior notice.

* Values determined at an air volume flow of 80 l/min (outlet of heating tube device).

** Values determined together with AIRSTREAM 100

*** The air volume at the nozzle is smaller because around 20 % of the supply air volume is required for protective tube cooling.

	PENWELD S	PENWELD A
Infinitely adjustable heating output with potentiometer	•	
Display for showing target/actual temperature (°C/°F)		•
Temperature controlled	•	
Temperature regulated		•
Adjustable temperature limiter		•
Work light		•
Rotatable hose connection (300°)	•	•
Standard hose	•	
Flex hose		•

4. Dimensions

4.1 Terminal box

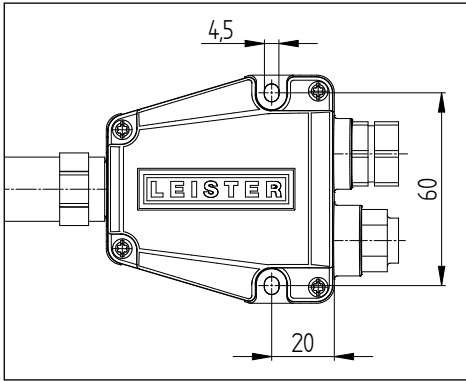

Only attach the connection box to the points provided for this purpose.

4.2 PENWELD 305 A/S

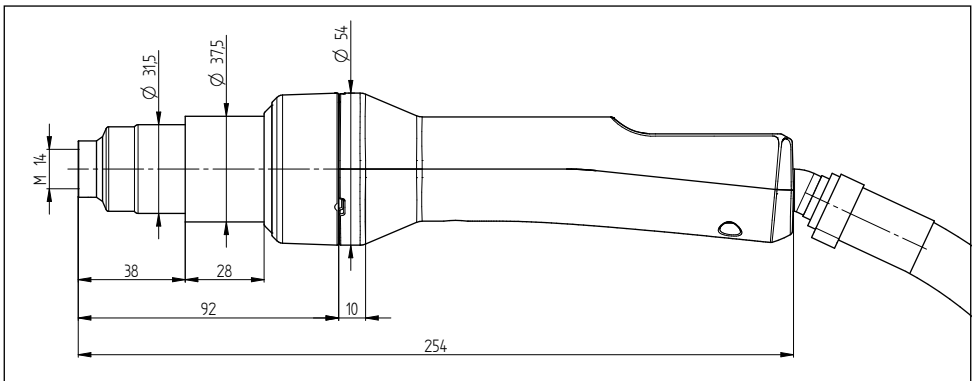

4.3 PENWELD 500 A/S (505-A)

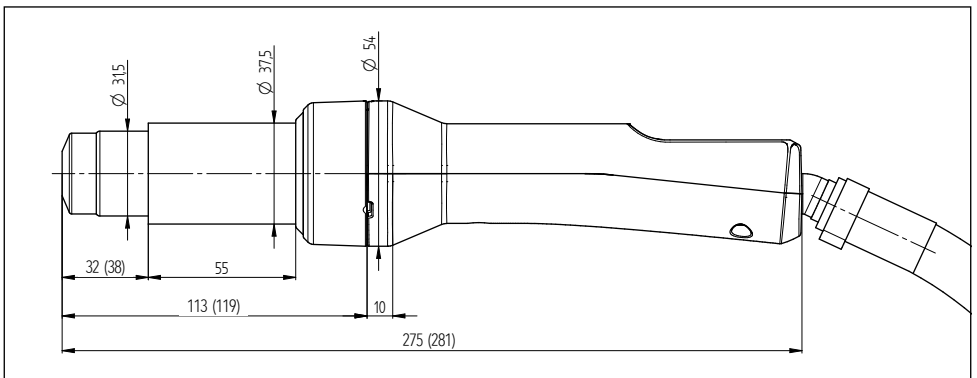

5. Your PENWELD

5.1 Type plate and identification

The model and serial number are indicated on your device's **type plate (9)**.

Please transfer this information to your instruction manual. In the event of any inquiries to our representatives or authorized Leister Service Centers, please always refer to this information.

Model:

Serial no.:

Example:

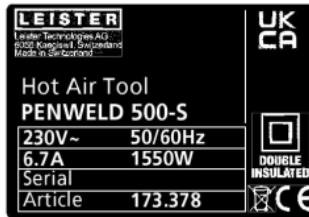

5.2 Overview of device parts

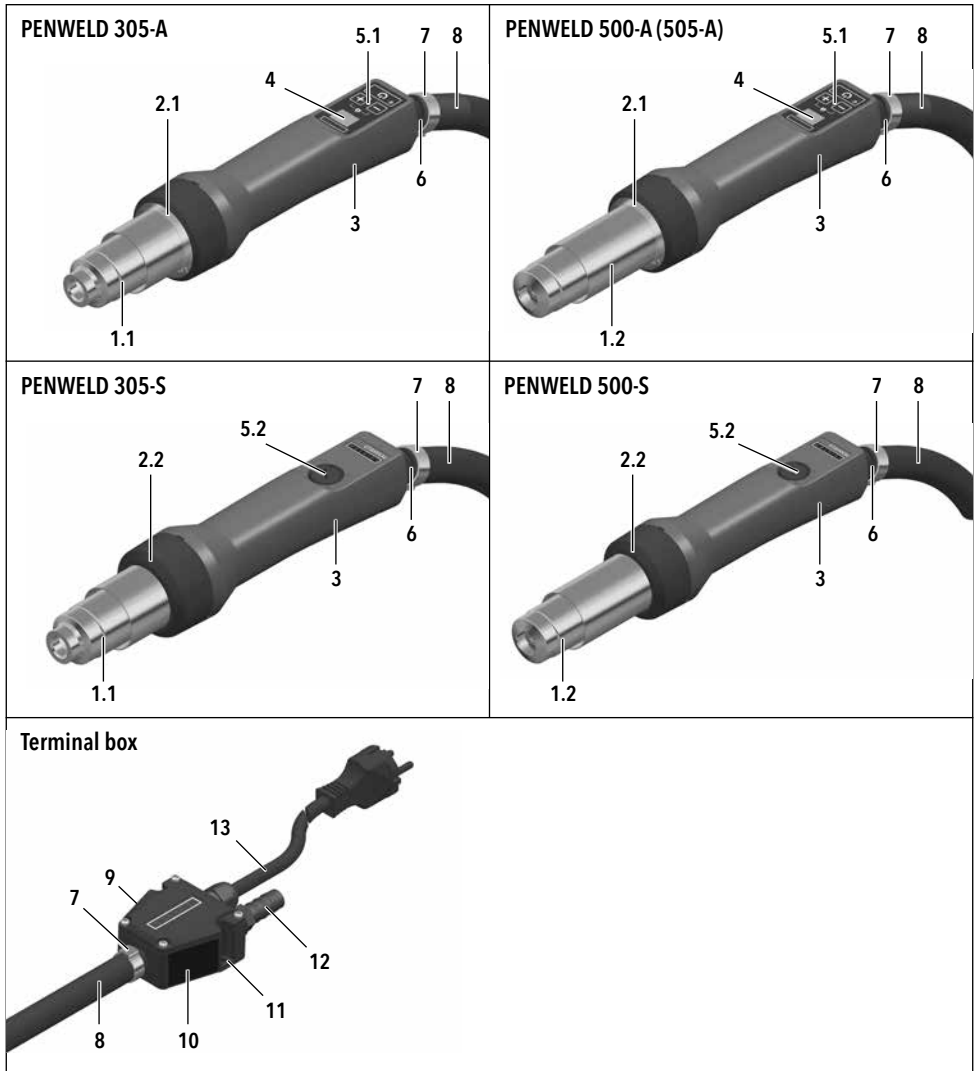

- 1.1. Heating tube for screwed nozzles (M14x1) *
- 1.2. Heating tube for push-fit nozzles *
- 2.1. Cover with working light
- 2.2. Cover without working light
- 3. Handle
- 4. Display
- 5.1. Function keys
- 5.2. Rotary knob for temperature setting
- 6. Rotatable hose connection (300°)

- 7. Hose clamp
- 8. Air hose with internally guided power cord
- 9. Type plate
- 10. Safety Instructions
- 11. Mounting plate connection box
- 12. Air hose connection (ø 14 mm)
- 13. Power cord

* Nozzles not included.

6. Using PENWELD For the First Time



Risk of death from electric shock due to dangerous electrical voltage

- The device is only to be connected to sockets and extension cables with a protective earth conductor.
- Protect the device from moisture and wet conditions.
- When used on a construction site, a residual current circuit breaker is mandatory.
- Prior to using the device for the first time, check the power cord, the plug, and the extension cable for electrical and mechanical damage.



Danger of fire and explosion with improper installation and use

- Avoid overheating of the material.
- Never place the device near combustible materials and/or explosive gases.
- Never place the device close to combustible materials and/or explosive gases while it is running and/or hot.
- Secure the device in resting position against falling/rolling.



Fire and explosion hazard in the event of a grid interruption

- Note that depending on the configuration/setting, the heater starts automatically after a mains interruption and the device regulates itself to the last set temperature.
- Place the device in a correct resting position during power mains interruption: not near flammable materials and/or explosive gases; never pointed at objects, people or animals).



Tripping hazard when air **hose is not carefully placed**

- Note that there is a risk of tripping if the air hose is not carefully placed.
- Ensure that hoses/lines are free to move and do not interfere with users or third parties at work.



Danger of glare due to the work light of the PENWELD A

- Avoid direct eye contact with the work light.



Risk of poisoning when working with plastics, paints and similar materials

- Note that when working with plastics, paints, and similar materials, aggressive and/or toxic gases may be produced.
- Avoid breathing in vapors, even if they seem to be harmless.
- Consider the material specifications and use the correct welding parameters.
- Always ensure good ventilation of the workplace when working.
- Wear a respirator.

6.1 Air supply

- To protect the unit and heating element, do not fail to meet the minimum air volume and do not exceed the maximum supply air temperature (see technical data). If the minimum air volume is no longer present, then the heating output must be interrupted at once.
- Note the flow direction.
- The maximum air pressure must never be exceeded in the compressed air connection (see technical data).
- **Use an air filter if there is dusty air.** In cases of particularly critical dusts (e.g. metal, electrically conductive or moist dusts), special filters must be used in order to avoid short circuits in the device.

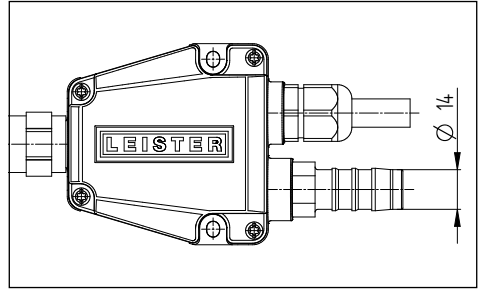

Caution

- Always operate the device with air supply.
- At the end of each unit use, turn off the heating.
- After turning off the heater, hold the air supply for a few minutes to cool the unit.

6.2 Install nozzle*



Danger of burns when touching the hot nozzle

- Before installing or changing the nozzle, allow the unit to cool completely or use suitable tools.



Fire hazard due to hot nozzle

- Note that the hot nozzle can ignite flammable materials.
- Place the hot nozzle on a fireproof surface.



Risk of equipment damage due to hot air jam

- Note that an incorrect or defective nozzle can cause hot air to jam, which damages the device.
- Only use suitable original Leister nozzles for the device.

* Nozzles not included.

7. Operating the PENWELD S

The control unit of the PENWELD S consists of the **rotary knob (5.2)**. Using the scale (1–10), use the **rotary knob (5.2)** to continuously adjust the target temperature. The following graphic shows the temperature curve by adjusting the rotary knob.

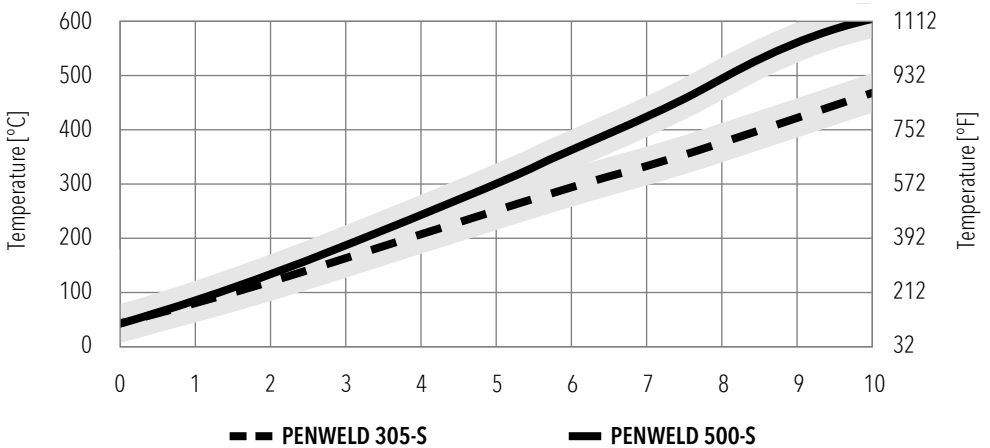

These are guide values determined using an air source of 80l/min. None of the data is guaranteed.

7.1 Turning on the PENWELD S



Caution

- Always operate the device with air supply.

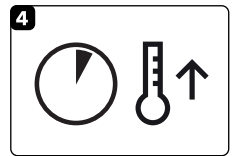
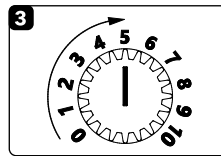
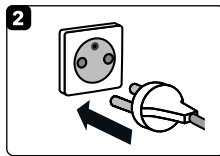
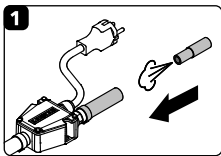



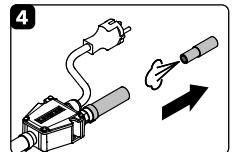
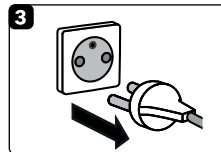
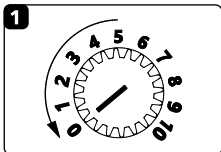





7.2 Turning off the PENWELD S



8. Operating the PENWELD A

The control unit of the PENWELD A consists of the **function keys (5.1)** with which the TARGET temperature can be set and the key lock can be switched on and off, the confirmation key for selecting the target values to be set as well as for setting the work light and the **display (4)**. The detailed application is described in the following subchapters.

8.1 Display icons

Symbol	Meaning	Symbol	Meaning
	Operating readiness		Input interlock
	Work Light 50 %		Work Light 100 %
	Increase temperature		Reduce temperature
NO	Without nozzle (Temperature calibrated for operation without nozzle)	N1	With nozzle (Temperature calibrated for operation with nozzle)
	Cooling process		Configuration menu
320 °C	Field for displaying the target and actual values. This is a three-digit display		

8.2 Turning on the PENWELD A

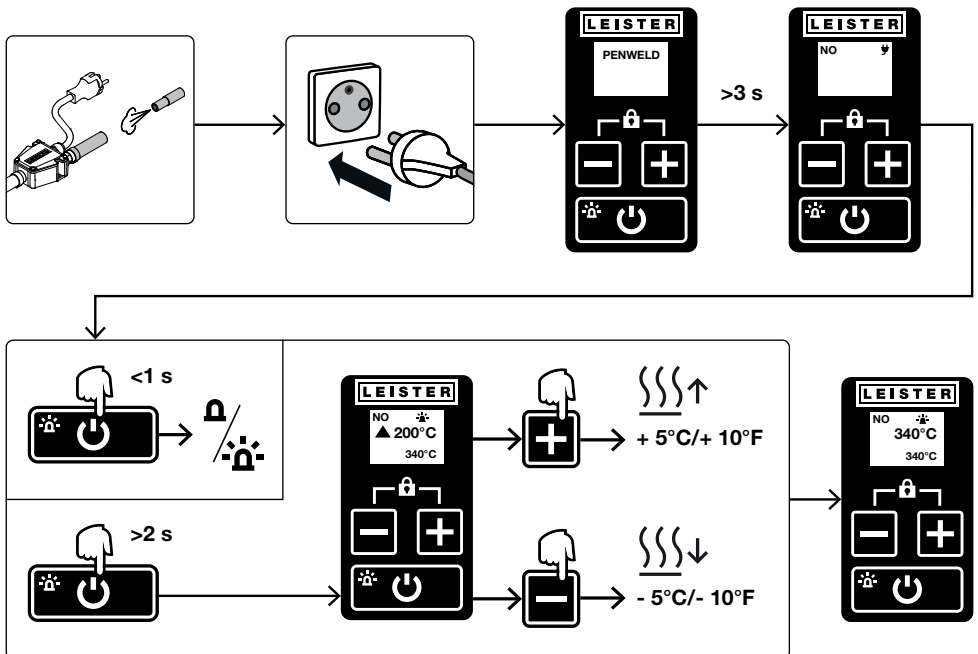

8.3 Key lock ON/OFF

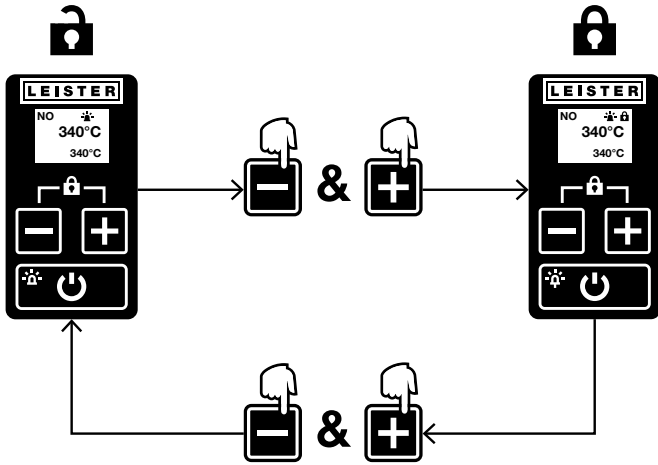

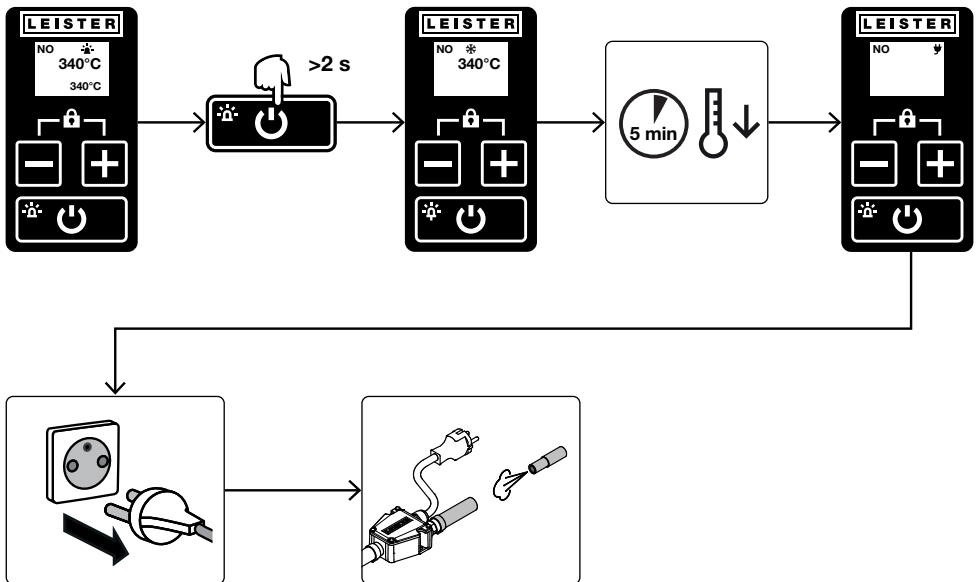

8.4 Turning off the PENWELD A



8.5 Configuration Setup Menu PENWELD A

Basic functions in the setup menu:

Button	Function
	<ul style="list-style-type: none"> Press 1 x briefly = selection / confirmation
	<ul style="list-style-type: none"> Navigating the menu Change value
	<ul style="list-style-type: none"> press = Exit Setup Menu Configuration

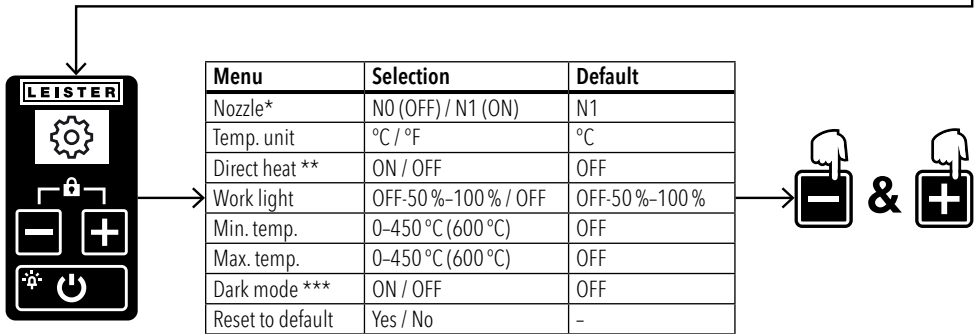
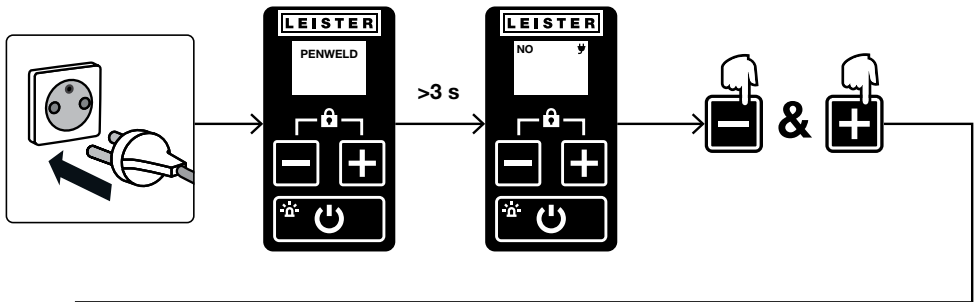

* **Nozzle:** N0 = Nozzleless operation and N1 = Nozzled operation (software adjusts temperature accordingly.)

** **Direct heat:** For Direct heat ON, the PENWELD A will start heating directly as soon as the **power cord (13)** is connected. The last temperature used is selected.

*** **Dark mode:** When switched off (OFF), the **display (4)** is white and the font/symbols are black. If the "Dark mode" is activated (ON), the **display (4)** is black and the font/symbols are white.

9. Warnings and Error Messages PENWELD A

Error group	Description	Measures
0001	Temperature probe	Allow device to cool down → Put back into operation. If the error occurs again, contact your Leister service center.
0004	Hardware	Allow device to cool down → Put back into operation. If the error occurs again, contact your Leister service center (Can also occur if the unit is operated with too little air).
0020	Heating element	Allow the device to cool down → Put back into operation, replace the heating element if it occurs repeatedly (see p. 12) or contact the responsible Leister service center.

10. Maintenance

10.1 General maintenance instructions



Risk of death from **electric shock** due to dangerous electrical voltage

- Disconnect the **power plug (13)** from the socket before working on the device.
- The device is only to be connected to sockets and extension cables with a protective earth conductor.
- Prior to using the device for the first time, check the power cord, the plug, and the extension cable for electrical and mechanical damage.



Danger of fire and explosion with improper installation and use

- Never place the device close to combustible materials and/or explosive gases while it is running and/or hot.
- Secure the device in resting position against falling/rolling.



Fire and explosion hazard in the event of a grid interruption

- Note that depending on the configuration/setting, the heater starts automatically after a mains interruption and the device regulates itself to the last set temperature.
- Place the device in a correct resting position during power mains interruption: not near flammable materials and/or explosive gases; never pointed at objects, people or animals).



Risk of burns from hot parts of the device

- Do not touch the heating tube and nozzle when they are hot. Always allow the device to cool down first.
- Never point the hot air flow at people and/or animals.



Danger of glare due to the work light of the PENWELD A

- Avoid direct eye contact with the work light.

- Keep the unit and air source clean. Do not use aggressive substances when cleaning.
- Only use original Leister accessories.

10.2 Heating element change

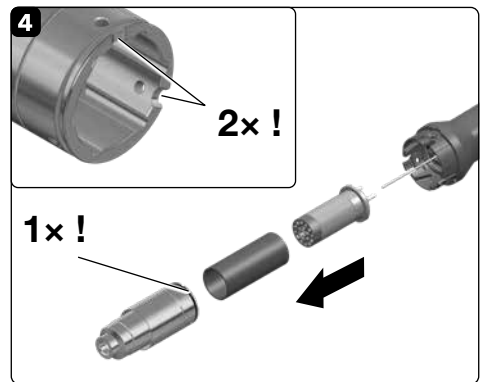
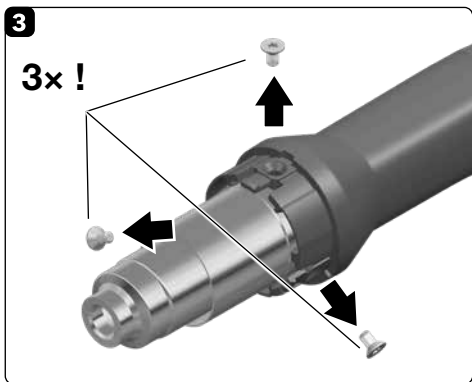
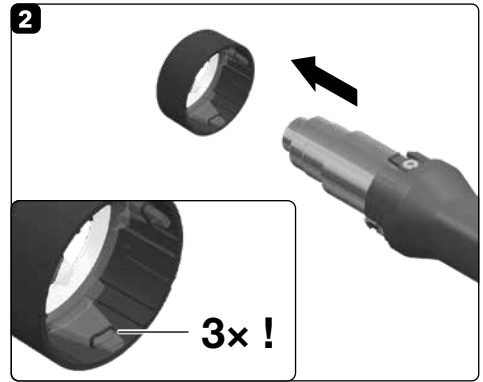
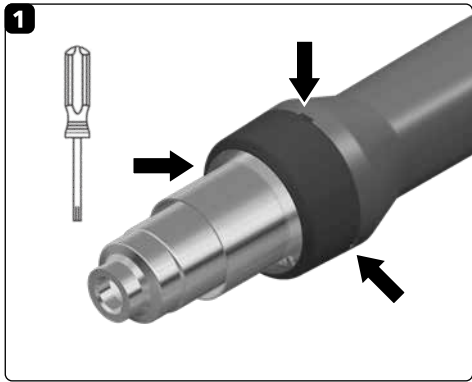

11. Declaration of Conformity

EU Declaration of Conformity

Leister Technologies AG, Galileo-Strasse 10, 6056 Kaegiswil, Switzerland confirms that this product fulfills the requirements of the following EU Guidelines in the models that we have made available for purchase.

Directives: 2006/42/EC, 2014/30/EU, 2014/53/EU, 2011/65/EU

Harmonized standards: EN ISO 12100, EN 60335-1, EN 60335-2-45, EN 62233, EN 55014-1, EN 55014-2, EN 61000-3-2, EN 61000-3-3, EN IEC 63000

Name of authorized representative for documentation: Thomas Schäfer, Manager Product Conformity

Kaegiswil, 11/21/2023

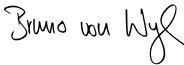

Bruno von Wyl, CTO



Pascal Bösch, VP R&D

UK Declaration of Conformity

Leister Technologies AG, Galileo-Strasse 10, 6056 Kaegiswil, Switzerland confirms that these products, in the versions as brought into circulation through us, fulfil the requirements of the following UK Statutory Instruments.

UK Statutory

Instruments: 2008 No. 1597, 2016 No. 1091, 2017 No. 1206, 2012 No. 3032

Designated Standards: EN ISO 12100, EN 60335-1, EN 60335-2-45, EN 62233, EN 55014-1, EN 55014-2,

EN 61000-3-2, EN 61000-3-3, EN IEC 63000

Name of authorized representative for documentation: Thomas Schäfer, Manager Product Conformity

Kaegiswil, 11/21/2023

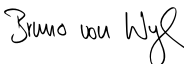

Bruno von Wyl, CTO



Pascal Bösch, VP R&D

12. Disposal



Do not dispose of electrical equipment with household refuse.

Electrical appliances, accessories and packaging should be recycled in an environmentally friendly manner. When you are disposing of our products, please observe the national and local regulations.

Warranty

- The guarantee or warranty rights granted for this device by the direct distribution partner/salesperson apply from the date of purchase. In the event of a guarantee or warranty claim (verification by invoice or delivery note), manufacturing or processing errors will be rectified by the sales partner through replacement delivery or repair. Heating elements are excluded from warranty obligations or guarantees.
- Other guarantee or warranty claims are excluded within the framework of mandatory law.
- Damage resulting from natural wear, overload, or improper handling is excluded from the warranty.
- No guarantee or warranty claims exist for devices that have been converted or modified by the purchaser.

↳ Sales and service center



Leister Technologies AG

Galileo-Strasse 10
6056 Kaegiswil
Switzerland
+41 41 662 74 74
leister@leister.com
leister.com