

LEISTER®



HOTWIND PREMIUM



HOTWIND SYSTEM



Leister Technologies AG
Galileo-Strasse 10
CH-6056 Kaegiswil/Switzerland

Tel. +41 41 662 74 74
Fax +41 41 662 74 16

www.leister.com
sales@leister.com

	Size	3	
D	Deutsch	Bedienungsanleitung	4
GB	English	Operating Instructions	16
I	Italiano	Istruzioni per l'uso	28
F	Français	Notice d'utilisation	40
E	Español	Instrucciones de funcionamiento	52
P	Português	Manual de instruções	64
S	Svenska	Bruksanvisning	76
TR	Türkçe	Kullanım Kılavuzu	88
CZ	Česky	Návod k obsluze	100
CN	中文	使用手册	112
J	日本語	取扱説明書	124

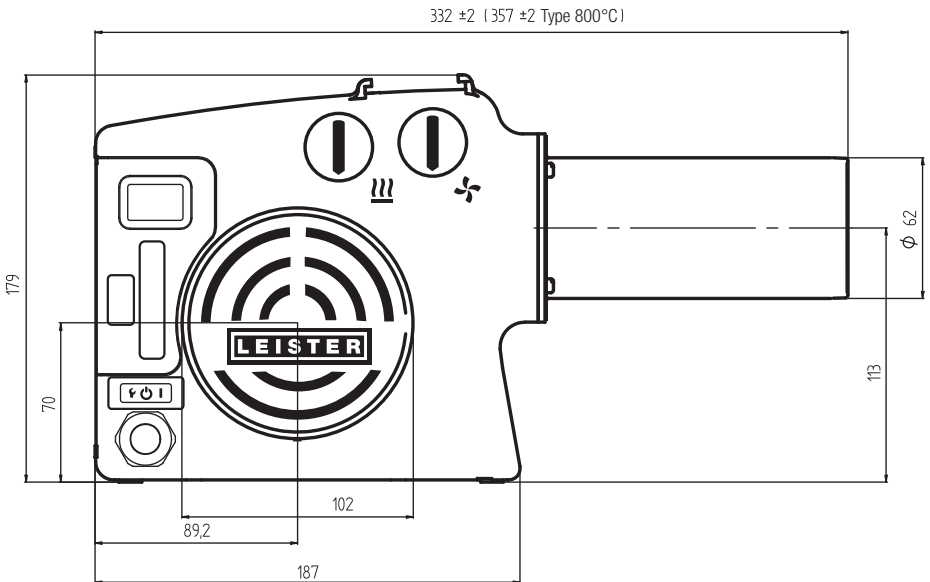
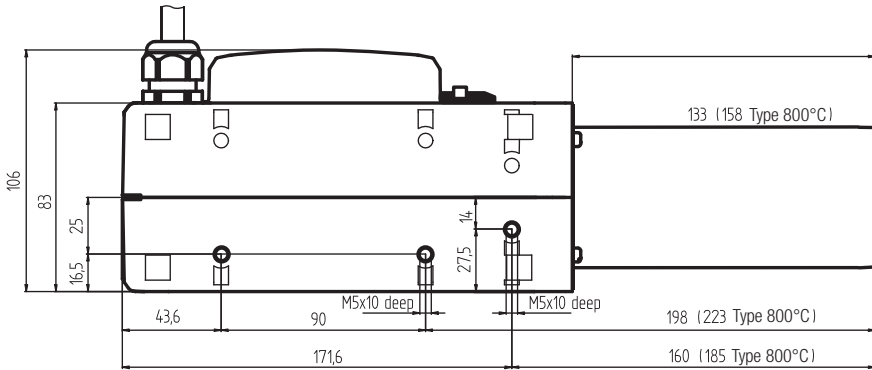



Bedienungsanleitung (Original-Bedienungsanleitung)

Wir gratulieren Ihnen zum Kauf eines HOTWIND!

Sie haben sich für ein erstklassiges Heissluftgebläse aus dem Hause Leister entschieden, welches aus hochwertigen Materialien besteht. Jeder HOTWIND wird einer strengen Qualitätskontrolle unterzogen bevor er das Werk in der Schweiz verlässt.



Bedienungsanleitung vor Inbetriebnahme aufmerksam lesen und zur weiteren Verfügung aufbewahren.

Heissluft-Gebläse HOTWIND PREMIUM, HOTWIND SYSTEM

Anwendung

Die Heissluft-Gebläse HOTWIND PREMIUM und HOTWIND SYSTEM sind für den Dauerbetrieb ausgelegt. Sie eignen sich hervorragend zum Einbau in Maschinen, Anlagen und Geräten oder auch als Handgeräte und Tischgeräte.

Ihre wichtigsten Anwendungen sind zum Beispiel **Trocknen und Aufheizen, Auftauen, Beschleunigen und Auflösen, Sterilisieren, Glätten, Glänzen, Aktivieren und Lösen, Trennen und Verschmelzen, Schrumpfen, Löten, Schweißen, Entfernen, Zünden.**



Warnung



Lebensgefahr beim Öffnen des Gerätes, da spannungsführende Komponenten und Anschlüsse freigelegt werden. Vor dem Öffnen des Gerätes Netzstecker aus der Steckdose ziehen.



Feuer- und Explosionsgefahr bei unsachgemäßem Gebrauch von Heissluftgeräten, besonders in der Nähe von brennbaren Materialien und explosiven Gasen.



Verbrennungsgefahr! Heizelementrohr und Düse nicht in heissem Zustand berühren. Gerät abkühlen lassen.
Heissluftstrahl nicht auf Personen oder Tiere richten.



Vorsicht



Nennspannung, die auf dem Gerät angegeben ist, muss mit der Netzspannung übereinstimmen. EN 61000-3-11; $Z_{max} = 0.053 \Omega + j 0.033 \Omega$. Gegebenenfalls Elektrizitäts-Versorgungs-Unternehmen konsultieren.



FI-Schalter beim Einsatz des Gerätes auf Baustellen ist für den Personenschutz dringend erforderlich.



Gerät **muss beobachtet** betrieben werden. Wärme kann zu brennbaren Materialien gelangen, die sich ausser Sichtweite befinden.

Gerät darf nur von **ausgebildeten Fachleuten** oder unter deren Aufsicht benützt werden. Kindern ist die Benützung gänzlich untersagt.



Gerät **vor Feuchtigkeit und Nässe schützen.**

Einbauerklärung

(Im Sinne der EG-Maschinenrichtlinie 2006/42; Anhang II B)

Leister Technologies AG, Galileo-Strasse 10, CH-6056 Kaegiswil / Schweiz erklärt hiermit, dass die unvollständige Maschine

Bezeichnung: **Heissluft-Gebläse**
Typ: **HOTWIND**
Ausführung: **PREMIUM oder SYSTEM**

– soweit es vom Lieferumfang her möglich ist – den anwendbaren grundlegenden Anforderungen der EG-Maschinenrichtlinie (2006/42) entspricht.

Die unvollständige Maschine entspricht überdies den Anforderungen der folgenden EG-Richtlinie(n):

EG-Richtlinie(n): Elektromagnetische Verträglichkeit 2004/108
Niederspannungsrichtlinie 2006/95

Harmonisierte Normen: EN 12100-1, EN 12100-2, EN 60204-1, EN 14121-1,
EN 55014-1, EN 55014-2, EN 61000-6-2,
EN 61000-3-2, EN 61000-3-3, EN 61000-3-11 (Z_{max})
EN 50366, EN 62233, EN 60335-2-45

Ferner erklären wir, dass für diese unvollständige Maschine die speziellen technischen Unterlagen gemäss Anhang VII (Teil B) erstellt wurden und verpflichten uns, diese auf begründetes Verlangen den Marktüberwachungsbehörden elektronisch zu übermitteln.

Name des Dokumentationsbevollmächtigten: Patrick Rieder, Compliance Manager

Die Inbetriebnahme der unvollständigen Maschine wird so lange untersagt, bis gegebenenfalls festgestellt wurde, dass die Maschine, in die die unvollständige Maschine eingebaut wurde, den Bestimmungen der EG-Maschinenrichtlinie (2006/42) entspricht.

Kaegiswil, 28.11.2011

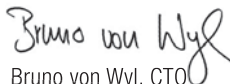
Bruno von Wyl, CTO

Beat Mettler, COO

Entsorgung



Elektrowerkzeuge, Zubehör und Verpackungen sollen einer umweltgerechten Wiederverwertung zugeführt werden. Nur für EU-Länder: Werfen Sie Elektrowerkzeuge nicht in den Hausmüll! Gemäss der Europäischen Richtlinie 2002/96 über Elektro- und Elektronik-Altgeräte und ihrer Umsetzung in nationales Recht müssen nicht mehr gebrauchsfähige Elektrowerkzeuge getrennt gesammelt und einer umweltgerechten Wiederverwertung zugeführt werden.

Technische Daten

Spannung	V~	120	230	230	230	400
Leistung	W	2300	2300	3100	3680	5400
Frequenz	Hz	50/60				
Max. Luftaustritts-temperatur	°C	650	650	800	650	650
Luftmenge (20 °C)	l/min.	200 – 900				
Statischer Druck max.	Pa	820	1050			
Emissionspegel	L_{pA} (dB)	< 70				
Gewicht ohne Netzanschlussleitung	kg	2.2	2.2	2.3	2.2	2.4
Masse		Seite 3 (Size)				
Konformitätszeichen		CE				
Sicherheitszeichen						
Zertifizierungsart						
Schutzklasse II		□				
Technische Änderungen vorbehalten						
Anschlussspannung nicht umschaltbar						

	PREMIUM	SYSTEM
Heizleistung und Luftmenge mit Potentiometer stufenlos einstellbar	•	•
Integrierte Leistungselektronik	•	•
Schutz vor Heizelement- und Geräteüberhitzung	•	•
Alarmausgang		•
Integrierter Temperaturregler		•
Fernsteuer-Schnittstelle für Temperatur- oder Leistungsvorgabe		•
Fernsteuer-Schnittstelle für Luftmengenvorgabe		•
Integrierte Temperatursonde		•
Display zur Anzeige der Soll- und Ist-Werte (°C oder °F)		•

Technische Daten Schnittstelle

PREMIUM, SYSTEM Relaisausgang	Max. Spannungen	AC 250 V, DC 30 V
	Max. Ströme	AC 3 A, DC 3 A
	Max. Kontaktwiderstand	100 m Ohm bei DC 6 V / 1 A
	Kontaktart	SPST - NO
	Isolation IEC/EN 60065	AC 2000 V (50 - 60 Hz) 1 min

SYSTEM Signaleingänge mit Verpolungsschutz und Nullpunktkorrektur	Isolation IEC/EN 60747-5-2	AC 1414 V Peak
	Spannungseingang U_c bezogen auf GND iso	DC 0 - 10 V (Rippel < 0.05 V bei 5 °C Auflösung) (Rippel < 0.1 V bei 1 % Auflösung)
	Max. Eingangsspannung	DC 12 V
	Nenn-Eingangswiderstand	280 kOhm
	Stromeingang I_c (2 - Leiter Technik)	DC 4 ... 20 mA (Rippel < 0.1 mA bei 5 °C Auflösung) (Rippel < 0.15 mA bei 1 % Auflösung)
	Max. Eingangsstrom	DC 22 mA
	Nenn-Eingangswiderstand	160 Ohm
	Speisung mit Verpolungsschutz ohne Trennung von den Signaleingängen	Betriebsspannung U_s bezogen auf GND iso
Max. Betriebsspannung		DC 25 V
Stromaufnahme		12 mA bei DC 24 V

Open Loop oder Closed Loop	Stellfunktion Leistung	Stellgrad OFF ... 100 %; 1% Schritte
	Reglerfunktion Temperatur	Sollwertvorgabe 50 °C ... 650 °C, 5 °C Schritte
Sollwertvorgabe Potentiometer oder Schnittstelle	Internes Potentiometer	Sollwert OFF ... 100 % oder 50 °C ... 650 °C
	Externe Schnittstelle	Sollwert OFF ... 100 % oder 50 °C ... 650 °C

Gerätebeschreibung

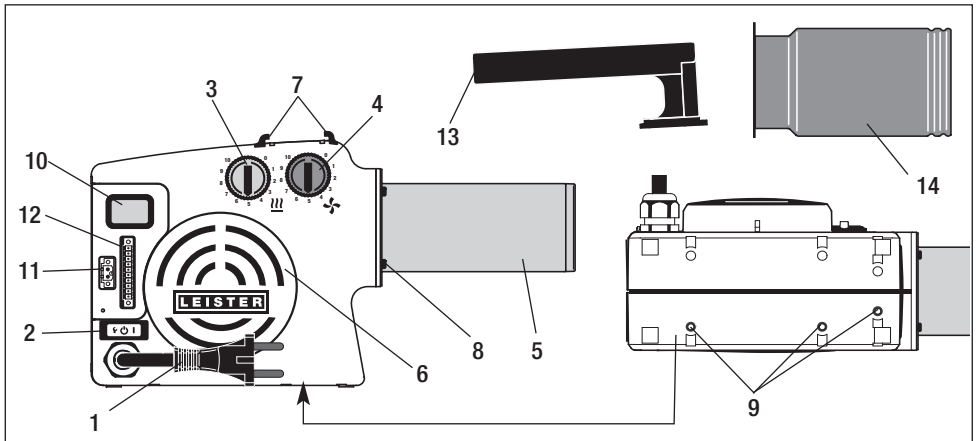

HOTWIND PREMIUM oder SYSTEM

- 1 Netzanschlussleitung
- 2 Hauptschalter mit Funktionstaste
- 3 Potentiometer für Temperatur (rot)
- 4 Potentiometer für Luftmenge (blau)
- 5 Heizelementrohr
- 6 Lufteinlassflansch für Edelstahlfilter
- 7 Halterung für Handgriff
- 8 Vier Befestigungsschrauben
- 9 Drei Gewindeeinsätze M5 zur Befestigung für den Einbau

HOTWIND SYSTEM

- 10 Display
- 11 Alarmkontakt
- 12 Schnittstelle

Handgerät HOTWIND PREMIUM oder SYSTEM

- 13 Handgriff
- 14 Schutzrohr

Funktion Heizelement- und Geräteschutz

- Überhitzt das Heizelement oder Gerät (zu warme Ansaugluft oder Wärmerückstau), wird die Leistungszufuhr zum Heizelement unterbrochen und der Arbeitskontakt des Alarmrelais geöffnet.
Sprechen Heizelementschutz oder Geräteschutz an, ist aus Sicherheitsgründen ein Rückstellen (Reset) des HOTWIND' nötig. Dies geschieht durch Drücken der **Funktionstaste (2)** während drei Sekunden. Ansaugluft überprüfen (siehe Einbau).



Einstellwerte Potentiometer

- Die interne Elektronik begrenzt die maximale Luftaustrittstemperatur auf 650 °C.
- Es sind Richtwerte welche aufgrund der Umgebungsbedingungen und Bauteiltoleranzen abweichen können.

Potentiometer Position	0	1	2	3	4	5	6	7	8	9	10
Heizleistung %	OFF	10	20	30	40	50	60	70	80	90	100
Luftmenge l/min	200	270	340	410	480	550	620	690	760	830	900
Temperatur (3680W) bei 300 l/min °C	Umgebung	90	150	215	275	340	400	465	525	590	650

Temperatur- / Luftmengen-Diagramm

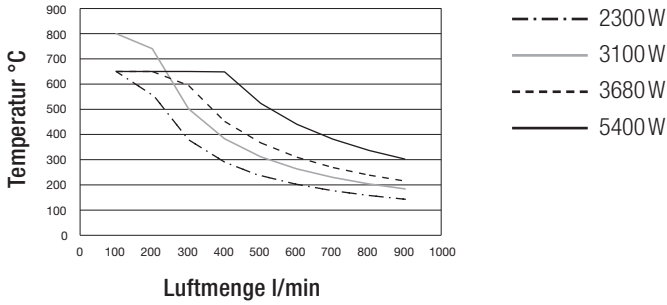

HOTWIND SYSTEM

Schnittstelle

11 Alarmkontakt

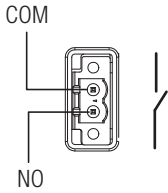

12 Schnittstelle

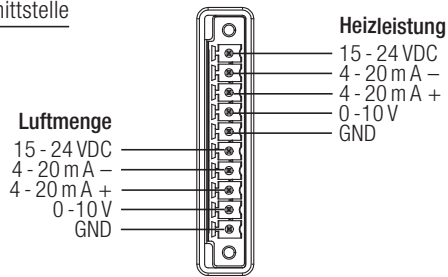

Im Netzanschluss muss eine geeignete Vorrichtung zur allpoligen Trennung vom Netz mit einem **Kontaktabstand von 3 mm** vorhanden sein.

Alarmkontakt: SPST-NO 250 VAC / 30 VDC, 3A $\cos \varphi = 1$

HOTWIND SYSTEM Ansteuerung

Input 0-10V

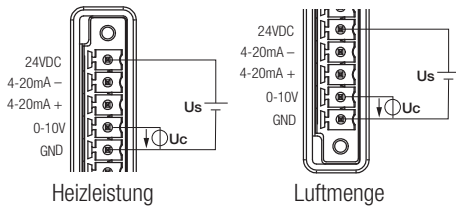

Leistung f (Steuerspannung)

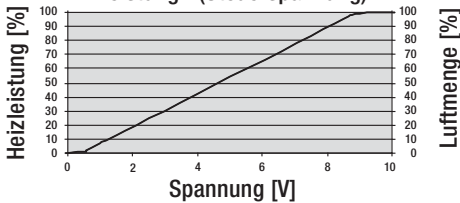

Input 4-20mA

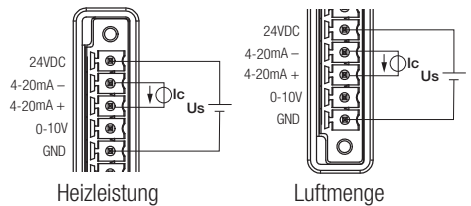

Leistung f (Steuersstrom)

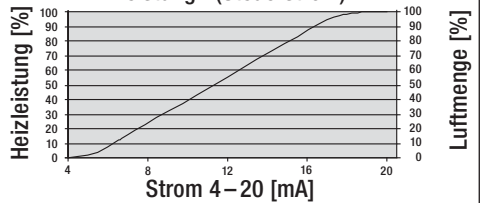

Achtung: Bei 0% Luftmenge ca. 200 l/min

Handle Kit

- Die Montage des Handle Kit darf nur von ausgebildeten Fachleuten oder unter deren Aufsicht vorgenommen werden.
- **Handgriff (13)** und **Schutzrohr (14)** sind im Lieferumfang nicht inbegriffen (siehe Zubehör).



Vor der Montage des Handle Kit das Gerät mittels **Hauptschalter (2)** ausschalten und abkühlen lassen. Gerät schaltet automatisch ab. 



Netzanschlussleitung (1) vom elektrischen Netz trennen.

Montage Handle Kit

- 1 **Handgriff (13)** auf die **Halterung (7)** schieben.
- 2 Die vier **Befestigungsschrauben (8)** lösen (nicht entfernen).
- 3 **Schutzrohr (14)** auf **Heizelementrohr (5)** schieben und in die Öffnung für **Befestigungsschrauben (8)** einfahren.
- 4 **Schutzrohr (14)** bis zum Anschlag drehen.
- 5 Die vier **Befestigungsschrauben (8)** festziehen.



Heizelement-Wechsel

- Der Heizelement-Wechsel darf nur von ausgebildeten Fachleuten oder unter deren Aufsicht vorgenommen werden.



1 **Hauptschalter (2)** ausschalten und Gerät abkühlen lassen. Gerät schaltet automatisch ab.



2 **Netzanschlussleitung (1)** vom elektrischen Netz trennen.

3 Die vier **Befestigungsschrauben (8)** entfernen. 4 **Heizelementrohr (5)** und Heizelement entfernen.

5 Heizelement aus der Verpackung nehmen. 6 Heizelement montieren und **Heizelementrohr (5)** aufschieben.

7 **Heizelementrohr (5)** mit vier **Befestigungsschrauben (8)** montieren.



8 **Netzanschlussleitung (1)** an das elektrische Netz anschließen. Nennspannung, die auf dem Gerät angegeben ist, muss mit der Netzspannung übereinstimmen.

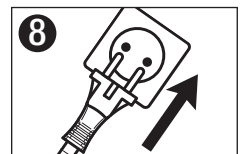
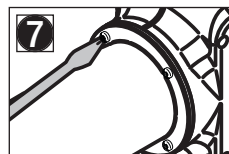
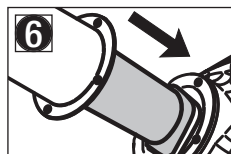
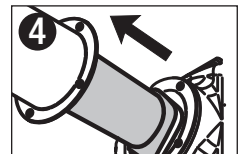
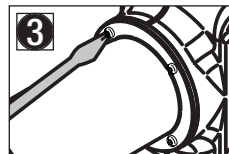
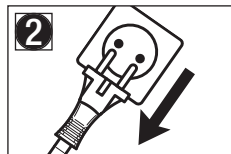
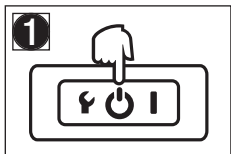

Düsen- / Reflektor-Wechsel



Verbrennungsgefahr! Heizelementrohr und Düse nicht in heissem Zustand berühren.

Beim Wechseln der Düse oder Reflektor zuvor Gerät mittels **Hauptschalter (2)**



ausschalten und abkühlen lassen. Gerät schaltet automatisch ab.

Einbau

- Gerät darf nur von ausgebildeten Fachleuten eingebaut werden.
- Einbaumasse siehe Seite 3, Masse / Size.



Vor dem Einbau Gerät mittels **Hauptschalter (2)**



ausschalten und abkühlen lassen. Gerät schaltet automatisch ab.



Netzanschlussleitung (1) vom elektrischen Netz trennen.

- Es muss sichergestellt sein, dass die Anschlussleitungen das Heizelementrohr nicht berühren und nicht dem Heissluftstrahl ausgesetzt sind.
- Gerät muss mit drei M5-Schrauben an den **Gewindeeinsätzen (9)** befestigt werden.
- Der Einbau muss gewährleisten, dass
 - nur kalte Luft zugeführt wird
 - kein (Wärme-) Rückstau entsteht
 - das Gerät nicht vom Heissluftstrahl eines anderen Gerätes angeströmt wird.
- Bei staubhaltiger Luft Leister-Edelstahlfilter (siehe Zubehör) verwenden und auf den **Lufteinlassflansch (6)** schieben.
- Bei besonders kritischen Stäuben (z.B. Metall-, elektrisch leitende, oder feuchte Stäube) müssen spezielle Filter verwendet werden, um Kurzschlüsse im Gerät zu vermeiden.
- Das Gerät vor mechanischen Vibrationen und Erschütterungen schützen.

Betrieb

- Nach Bedarf entsprechende Düse oder Reflektor montieren.



Es muss darauf geachtet werden, dass die Heissluft frei ausströmen kann, da ansonsten durch Wärmerückstau das Gerät Schaden erleiden kann (Brandgefahr!).



Netzanschlussleitung (1) an das elektrische Netz anschliessen. Nennspannung, die auf dem Gerät angegeben ist, muss mit der Netzspannung übereinstimmen.

- **Hauptschalter (2)**



einschalten



Gerät nach dem Heizbetrieb mittels **Hauptschalter (2)**



ausschalten und abkühlen lassen. Gerät schaltet automatisch ab.



Netzanschlussleitung (1) vom elektrischen Netz trennen.

- **ACHTUNG:** Bei Verwendung als Einbaugerät muss im Netzanschluss eine geeignete Vorrichtung **zur allpoligen Trennung** vom Netz mit einem **Kontaktabstand von 3 mm** vorhanden sein.

Bedienung HOTWIND PREMIUM

- **Temperatur** mit rotem **Potentiometer (3)** einstellen.
- **Luftmenge** mit blauem **Potentiometer (4)** einstellen.

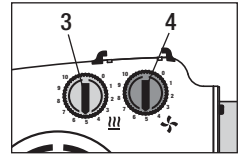

Bedienung HOTWIND SYSTEM

Potentiometer

- **Temperatur** mit rotem **Potentiometer (3)** einstellen.
- **Luftmenge** mit blauem **Potentiometer (4)** einstellen.

Systemschnittstelle

- Die Temperatur und Luftmenge kann über die **Systemschnittstelle (12)** gesteuert werden. Der Alarm kann über den **Alarm- Relaisausgang (11)** des Gerätes angeschlossen werden.

Das **Potentiometer für Temperatur (3)** und das Potentiometer für **Luftmenge (4)** haben keine Funktion mehr.

- Für Umstellung zwischen Potentiometer oder Schnittstelle siehe Konfiguration Seite 13.

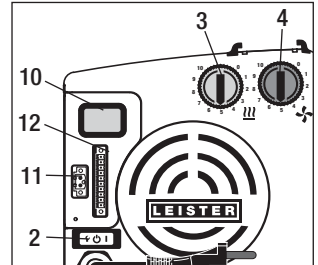

Display (10) HOTWIND SYSTEM

Im Menü Setup entsprechende Einstellungen vornehmen (siehe Seite 13).

- **Interne Regelung (Closed Loop)**
 - **Temperatur** mit rotem **Potentiometer (3)** einstellen.
 - **Luftmenge** mit blauem **Potentiometer (4)** einstellen.



- **Externe Regelung (Closed Loop)**
 - **Temperatur** mittels **externem Regler** einstellen.
 - **Luftmenge** mittels **externem Regler** einstellen.

Das Display zeigt Ist- und Sollwert der Temperatur an



- **Interne Steuerung (Open Loop)**
 - **Leistungs-Sollwert** mit rotem **Potentiometer (3)** für Temperatur einstellen.
 - **Luftmengen-Sollwert** mittels blauem **Potentiometer (4)** für Luftmenge einstellen.



- **Externe Steuerung (Open Loop)**
 - **Leistungs-Sollwert** mittels **externem Regler** für Temperatur einstellen.
 - **Luftmengen-Sollwert** mittels **externem Regler** für Luftmenge einstellen.

Das Display zeigt den Leistungssollwert in % und den Istwert der Temperatur an

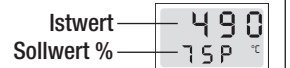

Konfiguration und Bedienung HOTWIND SYSTEM

Netzanschlussleitung (1)

an das elektrische Netz anschliessen



Hauptschalter (2)

EIN



Funktionstaste (2)

3 Sekunden drücken

Menü Setup

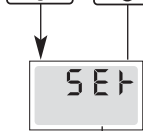

Funktionstaste (2)

1 x kurz drücken



Hauptschalter (2)

EIN



Funktionstaste (2)

3 Sekunden drücken

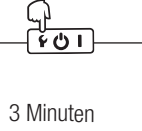

3 Minuten

Heizung

Cool Down

Legende

Anzeige	Beschreibung
RI r (Air)	Sollwert Luftmenge
CEL (°C)	Celsius
CLO (Closed Loop)	Geregelt
CON (Connector)	Schnittstelle
FRr (°F)	Fahrenheit
HER (Heater)	Sollwert Heizung
LOO (Loop)	Regelung
OPE (Open Loop)	Gesteuert
POT (Pot)	Potentiometer
SET (Setup)	Konfiguration
Un: (Unit)	Einheit

Wird im **Menü Setup** 10 Sekunden die **Funktionstaste (2)** nicht gedrückt schaltet das Gerät automatisch auf **Stand by**

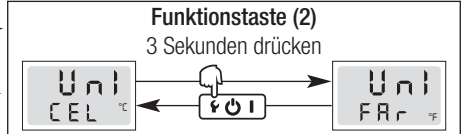

Funktionstaste (2)

1 x kurz drücken



Funktionstaste (2)

3 Sekunden drücken

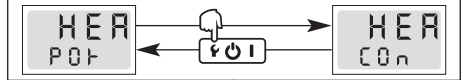

Funktionstaste (2)

1 x kurz drücken



Funktionstaste (2)

3 Sekunden drücken

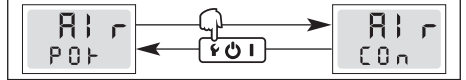

Funktionstaste (2)

1 x kurz drücken



Funktionstaste (2)

3 Sekunden drücken

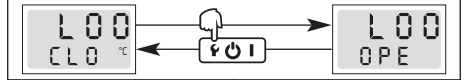

Funktionstaste (2)

1 x kurz drücken



Error

- Wenn eine Fehlfunktion des Gerätes auftritt, erscheint auf dem **Display (10)** eine Meldung, welche zusätzlich mit einem Error-Code versehen ist. Dieser Code steht für eine genauere Umschreibung des Fehlers (siehe Tabelle).
- Ein Error kann durch Drücken der **Funktionstaste (2)**  während drei Sekunden zurückgesetzt werden (Reset).

Display	Bezeichnung	Fehlerursache	Fehlerbehebung
Err 01	Gerätetemperatur zu hoch	Umgebungstemperatur grösser als spezifiziert	Umgebungstemperatur reduzieren
		Zulufttemperatur grösser als spezifiziert	Zulufttemperatur reduzieren
		Lufteinlass blockiert	Lufteinlass überprüfen
		Edelstahlfilter blockiert	Edelstahlfilter reinigen
		Luftauslass blockiert	Luftauslass überprüfen
		Falsche Düse montiert	Düse kontrollieren
Err 02	Heizelementtemperatur zu hoch	Lufteinlass blockiert	Lufteinlass überprüfen
		Edelstahlfilter blockiert	Edelstahlfilter reinigen
		Luftauslass blockiert	Luftauslass überprüfen
		Falsche Düse montiert	Düse wechseln
Err 03	Temperatursonde	Anschluss Temperatursonde fehlerhaft	Anschluss der Temperatursonde kontrollieren
		Temperatursonde defekt	Leister Service-Stelle kontaktieren
Err 04 Err 05 Err 06 Err 07 Err 08	Leister Service-Stelle kontaktieren		

Zubehör

- **Es darf nur Leister-Zubehör verwendet werden !**

Handle Kit Artikel No. 141.723
Edelstahl Filter Artikel No. 107.248

- Weitere Zubehör unter www.leister.com

Schulung

- Leister Technologies AG und deren autorisierte Service-Stellen bieten kostenlos Schweisskurse und Einschulungen an. Informationen unter www.leister.com.

Wartung

- Der **Lufteinlass (6)** ist bei Verschmutzung mit einem Pinsel zu reinigen
- **Netzanschlussleitung (1)** und Stecker auf elektrische und mechanische Beschädigungen überprüfen

Service und Reparatur

- Reparaturen sind ausschliesslich von autorisierten **Leister-Service-Stellen** ausführen zu lassen. Diese gewährleisten innert nützlicher Frist einen fachgerechten und zuverlässigen **Reparatur-Service** mit Original-Ersatzteilen gemäss Schaltplänen und Ersatzteillisten.

Gewährleistung

- Für dieses Gerät besteht eine grundsätzliche Gewährleistung von einem (1) Jahr ab Kaufdatum (Nachweis durch Rechnung oder Lieferschein). Entstandene Schäden werden durch Ersatzlieferung oder Reparatur beseitigt. Heizelemente sind von dieser Gewährleistung ausgeschlossen.
- Weitere Ansprüche sind, vorbehältlich gesetzlicher Bestimmungen, ausgeschlossen.
- Schäden, die auf natürliche Abnutzung, Überlastung oder unsachgemässe Behandlung zurückzuführen sind, werden von der Gewährleistung ausgeschlossen.
- Keine Ansprüche bestehen bei Geräten, die vom Käufer umgebaut oder verändert worden sind.

Congratulations on purchasing a HOTWIND!

You have chosen a top-class hot air blower by Leister, made from high-quality materials. Every HOTWIND undergoes stringent quality checks before leaving the factory in Switzerland.



Please read operating instructions carefully before use and keep for future reference.

Hot air blower HOTWIND PREMIUM, HOTWIND SYSTEM

Application

The HOTWIND PREMIUM hot air blower and HOTWIND SYTEM are designed for continuous operation. They are ideally suited for installation in machines, systems and devices or even as hand devices and table top units.

Their most important applications include; drying and heating, thawing, accelerating and removal, sterilising, smoothing, polishing, activation and dissolving, separating and fusing, shrinking, soldering, welding, removal, kindling..



Warning



Danger to life when opening the device as live components and connections are exposed. Unplug the line/mains plug from the plug socket before opening the device.



Incorrect use of the hot air blower can present a **fire and explosion hazard** especially near combustable materials and explosive gases.



Danger – can cause burns! Do not touch the heating element tube and nozzle while they are hot. Allow the device to cool. Do not direct hot-air stream towards people or animals.



Caution



The **nominal voltage** indicated on the device must correspond to the mains voltage. EN 61000-3-11; $Z_{max} = 0.053 \Omega + j 0.033 \Omega$. If necessary, consult your electricity supply utility.



For personal protection, we strongly recommend the tool be connected to an **RCCB (Residual Current Circuit Breaker)** before using it on construction sites.



The device **must not be left unattended** when in use. Heat can reach combustable materials which are out of sight. The device may only be used by **trained personnel** or under their supervision. Children may not use the device under any circumstances.



Keep **away from wet and damp areas.**

Installation declaration

(in terms of the EC machinery directive 2006/42; Appendix II B)

Leister Technologies AG, Galileo-Strasse 10, CH-6056 Kaegiswil/Switzerland hereby declares the partly completed machinery

Designation: **Hot air blower**
Type: **HOTWIND**
Option: **PREMIUM or SYSTEM**

– as far as it is possible from the scope of supply – fulfills the applicable essential requirements of the EC machinery directive (2006/42).

The partly completed machinery furthermore complies with the provisions of the following EC directive(s):

EC directive(s): Electromagnetic Compatibility 2004/108
Low Voltage Directive 2006/95

Harmonised standards: EN 12100-1, EN 12100-2, EN 60204-1, EN 14121-1,
EN 55014-1, EN 55014-2, EN 61000-6-2,
EN 61000-3-2, EN 61000-3-3, EN 61000-3-11 (Z_{max})
EN 50366, EN 62233, EN 60335-2-45

In addition, we declare the relevant technical documentation for this partly completed machinery is compiled in accordance with Annex VII (part B) and will be electronically transmitted to national authorities in response to a reasoned request. Authorised documentation representative: Patrick Rieder, Compliance Manager

The partly completed machine must not be put into service until the final machinery into which it is to be incorporated has been declared in conformity with the provisions of the EC machinery directive (2006/42), where appropriate.

Kaegiswil, 28.11.2011

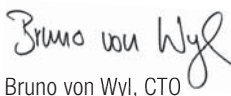
Bruno von Wyl, CTO



Beat Mettler, COO

Disposal



Power tools, accessories and packaging should be recycled. **For EU countries only:** do not dispose of power tools in your household rubbish! According to the European Directive 2002/96 on waste electrical and electric equipment and its implementation in national law, power tools which can no longer be used must be collected separately and recycled.

Technical Data

Voltage	V~	120	230	230	230	400
Power consumption	W	2300	2300	3100	3680	5400
Frequency	Hz	50/60				
Max. air outlet temperature	°C	650	650	800	650	650
Air volume (20 °C)	l/min.	200 – 900				
Max. static pressure	Pa	820	1050			
Emission level	L_{pA} (dB)	< 70				
Weight without power supply cord	kg	2.2	2.2	2.3	2.2	2.4
Dimensions	Page 3 (Size)					
Mark of conformity	CE					
Approval mark						
Certification scheme						
Protection class II	□					
Technical data and specifications are subject to change without prior notice						
Mains voltage cannot be switched over						

	PREMIUM	SYSTEM
Heat output and air volume steplessly adjustable with potentiometer	•	•
Integrated power electronics	•	•
Protection against heating element or device overheating	•	•
Alarm output		•
Integrated temperature control		•
Remote control interface for temperature or power set point		•
Remote control interface for air volume adjustment		•
Integrated temperature probe		•
Display for showing the setpoint and actual values (°C or °F)		•

Technical data for interface

PREMIUM, SYSTEM Relay output	Max. voltages	AC 250 V, DC 30 V
	Max. currents	AC 3 A, DC 3 A
	Max. contact resistance	100 m Ohm at DC 6 V / 1 A
	Relay contact	SPST - NO
	Insulation IEC/EN 60065	AC 2000 V (50 - 60Hz) 1 min

SYSTEM Signal inputs with reverse polarity protection and zero point correction	Insulation IEC/EN 60747-5-2	AC 1414 V Peak
	Voltage input U_c in relation to GND iso	DC 0 - 10 V (Ripple < 0.05 V at 5 °C resolution) (Ripple < 0.1 V at 1 % resolution)
	Max. input voltage	DC 12 V
	Nominal input resistance	280 kOhm
	Current input I_c (2 - conductor technology)	DC 4...20 mA (Ripple < 0.1 mA at 5 °C resolution) (Ripple < 0.15 mA at 1 % resolution)
	Max. input current	DC 22 mA
	Nominal input resistance	160 Ohm
	Supply with reverse polarity protection without separation of the signal inputs	Operating voltage U_s in relation to GND iso
Max. operating voltage		DC 25 V
Power consumption		12 mA at DC 24 V

Open loop or closed loop	Power setting function	setting level OFF...100 %; 1% steps
	Temperature control function	setpoint value specification 50 °C...650 °C, 5 °C steps
Setpoint entry Potentiometer or interface	Internal potentiometer	setpoint value OFF...100 % or 50 °C...650 °C
	Interface	setpoint value OFF...100 % or 50 °C...650 °C

Device Description

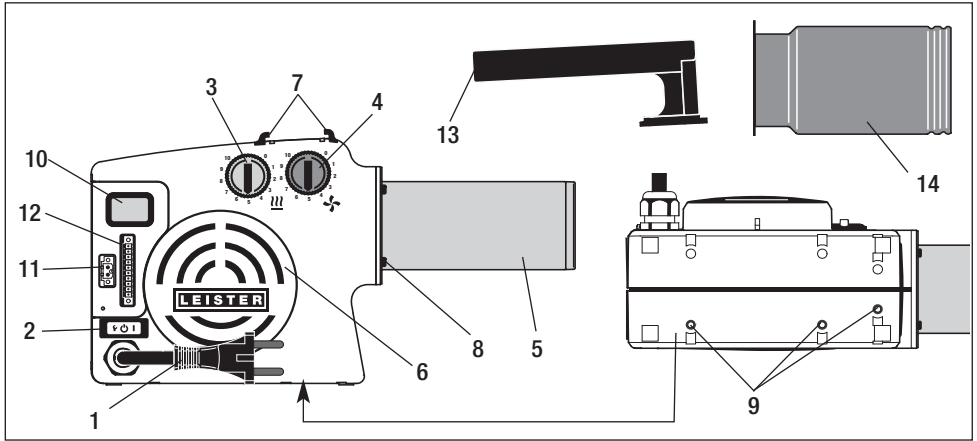

HOTWIND PREMIUM or SYSTEM

- 1 Power supply cord
- 2 Main switch with function button
- 3 Potentiometer for temperature (red)
- 4 Potentiometer for air volume (blue)
- 5 Heating element tube
- 6 Air inlet flange for stainless steel filter
- 7 Holder for handle
- 8 Four fastening screws
- 9 Three M5 thread inserts for fastening for installation

HOTWIND SYSTEM

- 10 Display
- 11 Alarm contact
- 12 Interface

HOTWIND PREMIUM hand device or SYSTEM

- 13 Handle
- 14 Protective tube

Function of heating element and device protection

- If the heating element or device overheats (too hot inlet air or excess heat residue), the power supply to the heating element will be interrupted and the working contact of the alarm relay opened. If the heating element or device protection responds, it will be necessary to reset the HOTWIND for reasons of safety. This occurs by pressing the **function button (2)**  for three seconds. Check inlet air (see installation).

Adjustable potentiometer

- The internal electronics regulates the maximum outlet air temperature to 650 °C.
- The reference values can be deviated from due to ambient conditions and component tolerances.

Potentiometer Position	0	1	2	3	4	5	6	7	8	9	10
Heating power %	OFF	10	20	30	40	50	60	70	80	90	100
Air volume l/min	200	270	340	410	480	550	620	690	760	830	900
Temperature (3680 W) at 300 l/min °C	Environment	90	150	215	275	340	400	465	525	590	650

Temperature / air volume diagram

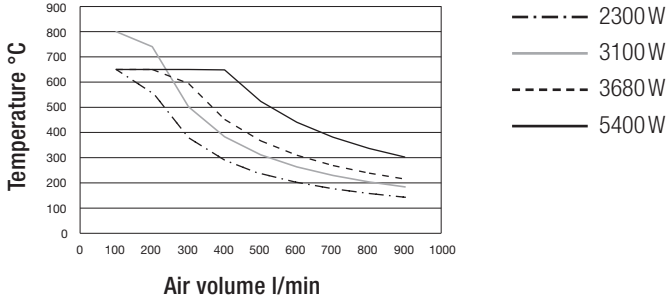

HOTWIND SYSTEM

Interface

11 Alarm contact

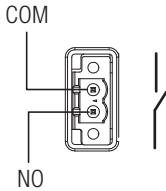

12 Interface

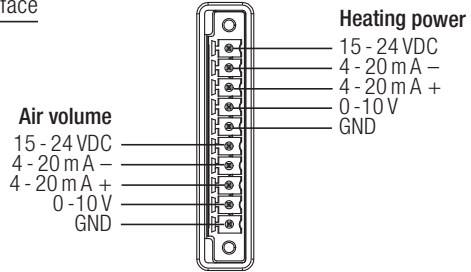

A suitable device for full disconnection from the mains with a contact distance of 3 mm must be provided in the mains connection.

Alarm contact: SPST-NO 250 VAC / 30 VDC, 3 A $\cos \varphi = 1$

HOTWIND SYSTEM control

Input 0 - 10 V

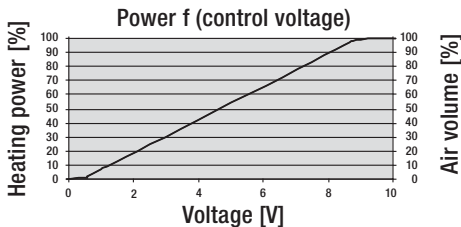
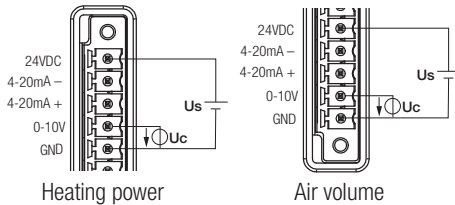

Input 4 - 20 mA

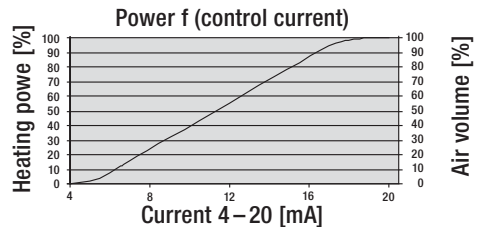
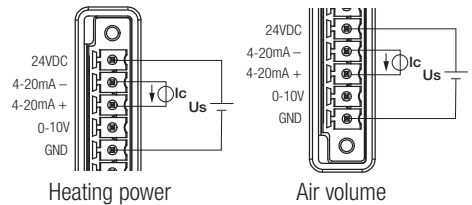

Achtung: Bei 0 % Luftmenge ca. 200 l/min

Handle Kit

- The assembly of the handle kit may only be used by trained personnel or under their supervision.
- **Handle (13)** and **protective tube (14)** are not included in the scope of supply (see accessories).



Prior to assembly of the handle kit, switch off the unit by the **main switch (2)** and allow the device to cool down. Machine switches off automatically.



Disconnect **power supply cord (1)** from the line/mains.

Handle kit assembly

- ➊ Push **handle (13)** onto the **holder (7)**.
- ➋ Loosen the **four fastening screws (8)** (do not remove).
- ➌ Push the **protective tube (14)** onto the **heating element tube (5)** and move in the opening for **fastening screws (8)**.
- ➍ Turn the **protective tube (14)** as far as it will go.
- ➎ Tighten the **four fastening screws (8)**.



Changing the heating element

- Changing the heating element may only be carried out by trained personnel or under their supervision.



➊ Switch off the **main switch (2)** and allow the unit to cool down. Machine switches off automatically.



➋ Disconnect **power supply cord (1)** from the line/mains.

➌ Remove the **four fastening screws (8)**. ➍ Remove the **heating element tube (5)** and heating element.

➎ Take the heating element out of its packaging. ➏ Assemble the heating element and push on the **heating element tube (5)**.

➐ Assemble the **heating element tube (5)** with **four fastening screws (8)**.



➑ Connect **power supply cord (1)** to the electrical mains. The nominal voltage indicated on the device must correspond to the mains voltage.

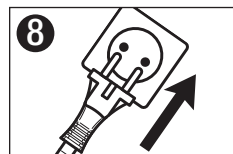
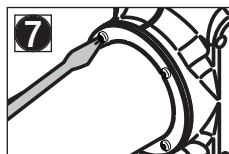
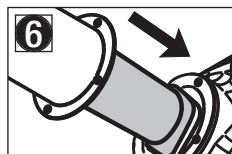
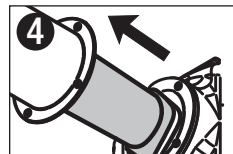
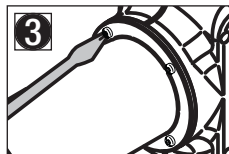
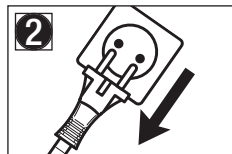
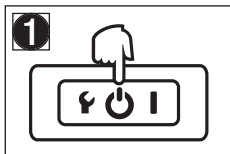

Changing the nozzle or reflector



Danger – can cause burns! Do not touch the heating element tube and nozzle while they are hot. Switch off the **main switch (2)**  and allow the unit to cool down before replacing the nozzle or reflector.

Machine switches off automatically.

Installation

- The device may only be installed by trained personnel.
- For installation dimensions, see page 3, dimensions/size.



Prior to installation of the device, switch off the unit by the **main switch (2)**  and allow the device to cool down. Machine switches off automatically.



Disconnect **power supply cord (1)** from the line/mains.

- It must be ensured that the connection lines do not come into contact with the heating element tube and are not exposed to the hot air jet.
- The device must be fastened with three M5 screws to the thread inserts.
- The installation must ensure that
 - only cold air is supplied
 - no excess (heat) residue builds up
 - the device is not subject to jets of hot air from another device.
- If the air contains dust use a Leister stainless steel filter (see accessories) and push it on the **air inlet flange (6)**.
- In the case of particularly critical dusts (e.g. metal, electrically conductive or damp dusts), special filters must be used to avoid short-circuits in the device.
- Protect the device from mechanical vibrations and shocks.

Operation

- Mount corresponding nozzle or reflector, if required.



It must be ensured that the hot air can flow out freely, as otherwise the device can be damaged by the excess heat building up (risk of fire!).



Connect **power supply cord (1)** to the electrical mains. The nominal voltage indicated on the device must correspond to the mains voltage.

- Switch on **main switch (2)** 



After heating mode, switch off the unit by the **main switch (2)**  and allow the device to cool down. Machine switches off automatically.



Disconnect **power supply cord (1)** from the line/mains.

- **WARNING:** When using as a built-in unit, a suitable device for full disconnection from the mains with a contact distance of 3 mm must be provided in the mains connection.

HOTWIND PREMIUM operation

- Set the temperature using the **red potentiometer (3)**.
- Set the air volume using the **blue potentiometer (4)**.

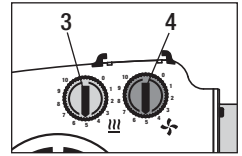

HOTWIND SYSTEM operation

Potentiometer

- Set the temperature using the **red potentiometer (3)**.
- Set the air volume using the **blue potentiometer (4)**.

System interface

- The temperature and the air volume can be controlled via the **system interface (12)**. The alarm can be connected via the units' **alarm relay output (11)**.

The **potentiometer for temperature (3)** and the **potentiometer for air volume (4)** no longer function.

- For switching between potentiometer or interface, see configuration, page 25.

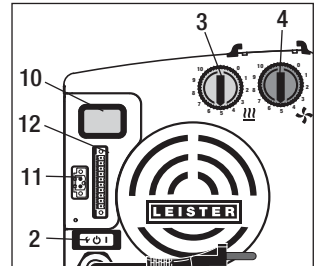

HOTWIND SYSTEM display (10)

Corresponding settings can be changed via the setup menu (see page 25).

- **Internal control (closed loop)**
 - Set the **temperature** using the **red potentiometer (3)**.
 - Set the **air volume** using the **blue potentiometer (4)**.



The display shows the actual and set point of the temperature

Actual value — 39.5
Set point value — 45.0 °C

- **External control (closed loop)**
 - Set the **temperature** using the **external controller**.
 - Set the **air volume** using the **external controller**.

- **Internal control (open loop)**
 - Set the **power set-point** using the **red potentiometer (3)** for the temperature.
 - Set the **air volume set-point** using the **blue potentiometer (4)** for air volume.



The display shows the capacity set point in % and the actual value of the temperature

Actual value — 49.0
Set point value % — 75 P °C

- **External control (open loop)**
 - Set the **power set-point** using the **external controller** for temperature.
 - Set **air volume set-point** using the **external controller** for air volume.

HOTWIND SYSTEM configuration and operation

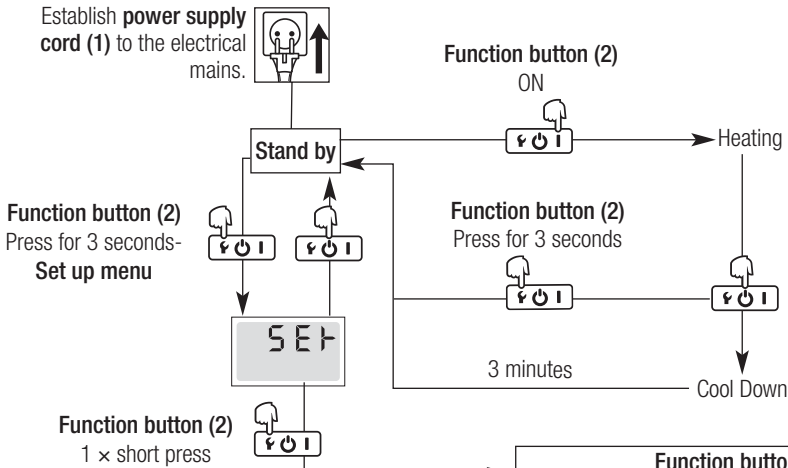

Legend

Display	Description
Ri r (Air)	Set point value – air volume
CEL (°C)	Celsius
CLO (Closed Loop)	Regulated
CON (Connector)	Interface
FRr (°F)	Fahrenheit
HEr (Heater)	Set point value – heating
LOO (Loop)	Control
OPE (Open Loop)	Controlled
POT (Pot)	Potentiometer
SEt (Setup)	Configuration
Un: (Unit)	Unit

If in the **set up** menu the **function button (2)** is not pressed for 10 seconds, the unit automatically switches to **stand by**

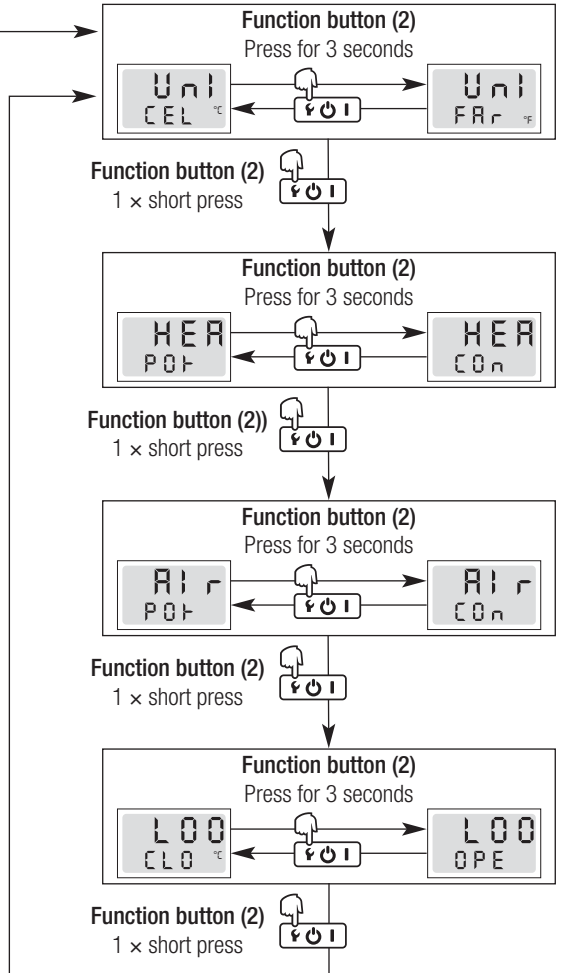

Error

- If a malfunction occurs in the unit, a message accompanied by an error code will appear on the **display (10)**. This code stands for a more precise definition of the error (see table)
- An error can be reset by pressing the **function button (2)**  for 3 seconds.

Display	Designation	Cause of error	Troubleshooting
Err 01	Unit temperature too high	Ambient temperature higher than specified	Reduce ambient temperature
		Inlet air temperature higher than specified	Reduce inlet air temperature
		Air inlet blocked	Check air inlet
		Stainless steel filter blocked	Clean stainless steel filter
		Air outlet blocked	Check air outlet
		Incorrect nozzle installed	Monitor nozzle
Err 02	Heating element temperature too high	Air inlet blocked	Check air inlet
		Stainless steel filter blocked	Clean stainless steel filter
		Air outlet blocked	Check air outlet
		Incorrect nozzle installed	Replace nozzle
Err 03	Temperature probe	Temperature probe connection faulty	Monitor the connection of the temperature probe
		Temperature probe defective	Contact Leister service point
Err 04 Err 05 Err 06 Err 07 Err 08	Contact Leister service point		

Accessories

- **Only Leister accessories should be used**

Handle kit Article no. 141.723
Stainless steel filter Article no. 107.248

- Further accessories at www.leister.com

Training

- Leister Technologies AG and its authorised Service Centres offer free welding courses and training. Informationen below www.leister.com.

Maintenance

- The **air inlet (6)** must be cleaned with a brush if soiled
- Check **power supply cord (1)** and plug for electrical and mechanical damage.

Service and Repairs

- Repairs should only be carried out by authorised **Leister Service Centres**. They guarantee a correct and reliable repair service within reasonable period, using original spare parts in accordance with the circuit diagrams and spare parts lists.

Warranty

- For this tool, we generally provide a warranty of one (1) year from the date of purchase (verified by invoice or delivery document). Damage that has occurred will be corrected by replacement or repair. Heating elements are excluded from this warranty.
- Additional claims shall be excluded, subject to statutory regulations.
- Damage caused by normal wear, overloading or improper handling is excluded from the guarantee.
- Warranty claims will be rejected for tools that have been altered or changed by the purchaser.



Istruzioni per l'uso (Traduzione del manuale di istruzioni originale)

Congratulazioni per l'acquisto di HOTWIND!

È stata scelta un'eccellente soffiatrice d'aria calda di Leister realizzata con materiali di alta qualità. Prima di uscire dallo stabilimento in Svizzera, tutti i modelli di HOTWIND sono sottoposti ad un rigoroso controllo di qualità.



Prima dell'attivazione leggere con attenzione le istruzioni per l'uso e conservarle per ulteriori consultazioni.

Soffiatrice di aria calda HOTWIND PREMIUM, HOTWIND SYSTEM

Modalità d'impiego

La soffiatrice di aria calda HOTWIND PREMIUM e la soffiatrice HOTWIND SYSTEM sono progettate per garantire il funzionamento continuo. Si adattano alla perfezione all'installazione in macchine, impianti e apparecchiatura o anche come dispositivi portatili e strumentazioni da banco.

Le sue più importanti applicazioni sono ad esempio **essiccazione e riscaldamento, scongelamento, accelerazione e miscelazione, sterilizzazione, levigatura, lucidatura, attivazione e allentamento, separazione e fusione, termoretrazione, saldatura, rimozione ed accensione.**



Avvertenze



Aperto l'apparecchio è presente il **pericolo di morte** perché vengono esposti componenti e collegamenti sotto tensione. Estrarre la spina elettrica prima di procedere all'apertura dell'apparecchio.



È presente il **pericolo di incendio e di esplosione** in caso di utilizzo non conforme degli apparecchi ad aria calda, in particolare nelle vicinanze di materiali infiammabili e gas esplosivi.



Pericolo di ustione! Non toccare il tubo della resistenza e l'ugello quando sono ancora ad alte temperature. Lasciar raffreddare l'apparecchio. Non orientare il getto di aria calda verso persone o animali.



Cautela



La **tensione nominale** specificata sull'apparecchio deve coincidere con la tensione di rete. EN 61000-3-11; $Z_{max} = 0.053 \Omega + j 0.033 \Omega$. In caso di necessità consultare l'azienda addetta all'erogazione della corrente elettrica.



Se si utilizza l'apparecchio in cantiere, sono tassativamente necessari gli **interruttori per correnti di guasto** per garantire la tutela del personale.



È necessario **mantenere** l'apparecchio **sotto controllo** durante il funzionamento. Il calore può raggiungere materiali infiammabili che si trovano fuori dal campo visivo.

L'impiego dell'apparecchio è consentito esclusivamente a **personale specializzato** o sotto il monitoraggio di quest'ultimo. È tassativamente vietato l'impiego da parte dei bambini.



Proteggere l'apparecchio **da umidità e da ambienti bagnati.**

Dichiarazione per l'installazione

(ai sensi della direttiva CE in materia di macchinari 2006/42, nota integrativa II B)

Con il presente documento **Leister Technologies AG, Galileo-Strasse 10, CH-6056 Kaegiswil / Svizzera** dichiara che la macchina incompleta

Descrizione: **Hot air blower**
Modello: **HOTWIND**
Versione: **PREMIUM o SYSTEM**

– soddisfa i requisiti fondamentali applicabili della direttiva in materia di macchinari CE (2006/42), a seconda delle possibilità previste dalla fornitura.

La macchina incompleta soddisfa inoltre i requisiti della/e direttiva/e CE riportata/e di seguito:

Direttiva/e CE: compatibilità elettromagnetica 2004/108
direttiva in materia di basse tensioni 2006/95

Normative armonizzate: EN 12100-1, EN 12100-2, EN 60204-1, EN 14121-1,
EN 55014-1, EN 55014-2, EN 61000-6-2,
EN 61000-3-2, EN 61000-3-3, EN 61000-3-11 (Z_{max})
EN 50366, EN 62233, EN 60335-2-45

Inoltre si dichiara di aver prodotto la documentazione tecnica speciale ai sensi della nota integrativa VII (sez. B) per la presente macchina incompleta con l'obbligo di fornirla su espressa richiesta in formato elettronico alle autorità competenti del monitoraggio del mercato.

Nominativo del responsabile della documentazione: Patrick Rieder, Compliance Manager

L'attivazione della macchina incompleta è vietata fino quando non sia stato eventualmente stabilito che la macchina, in cui è stata installata la macchina incompleta, soddisfi le disposizioni della direttiva in materia di macchinari CE (2006/42).

Kaegiswil, 28/11/2011

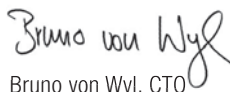
Bruno von Wyl, CTO

Beat Mettler, COO

Smaltimento



Gli apparecchi elettrici, gli accessori e gli imballaggi devono essere riciclati nel rispetto dell'ambiente. Solo per i paesi UE: non smaltire gli apparecchi elettrici insieme ai rifiuti domestici. Ai sensi della Direttiva Europea 2002/96 in materia di apparecchi elettrici ed elettronici usati e della relativa implementazione nella legislazione nazionale, è necessario raccogliere separatamente gli apparecchi elettrici non più utilizzabili e introdurli in un sistema di riciclaggio a basso impatto ambientale.

Specifiche tecniche

Tensione	V~	120	230	230	230	400
Potenza	W	2300	2300	3100	3680	5400
Frequenza	Hz	50/60				
Temperatura max. dell'aria in uscita	°C	650	650	800	650	650
Portata d'aria (20 °C)	l/min.	200 – 900				
Pressione statica max.	Pa	820	1050			
Livello di emissioni acustiche L _{pA} (dB)		< 70				
Peso senza linea di allacciamento alla rete	kg	2.2	2.2	2.3	2.2	2.4
Dimensioni		Pagina 3 (Size)				
Marchio di conformità		CE				
Marchio di sicurezza						
Tipo di certificazione						
Classe di protezione II		□				
Con riserva di modifiche tecniche						
Tensione di allacciamento non commutabile						

	PREMIUM	SYSTEM
Possibilità di regolazione in modo continuo della potenza di riscaldamento e della portata d'aria con il potenziometro	•	•
Impianto elettronico integrato della potenza	•	•
Protezione dal surriscaldamento della resistenza e dell'apparecchio	•	•
Uscita d'allarme		•
Termostato integrato		•
Interfaccia di controllo a distanza per la preimpostazione della temperatura e della potenza		•
Interfaccia remota per la preimpostazione della portata d'aria		•
Sonda termica integrata		•
Display di visualizzazione dei valori nominali e reali (°C o °F)		•

Specifiche tecniche dell'interfaccia

PREMIUM, SYSTEM Uscita relè	Tensioni max.	AC 250 V, DC 30 V
	Correnti max.	AC 3 A, DC 3 A
	Resistenza di contatto max.	100 m Ohm a DC 6 V / 1 A
	Tipo di contatto	SPST - NO
	Isolamento IEC/EN 60065	AC 2000 V (50 - 60 Hz) 1 min
SYSTEM Ingressi dei segnali con protezione sull'inversione di polarità e compensazione del punto neutro	Isolamento IEC/EN 60747-5-2	AC 1414 V Peak
	Ingresso della tensione U_c in riferimento a GND iso	DC 0 - 10 V (ondulazione < 0,05 V a 5 °C di risoluzione) (ondulazione < 0,1 V a 1% di risoluzione)
	Tensione d'ingresso max.	DC 12 V
	Resistenza d'ingresso nominale	280 kOhm
	Ingresso di corrente (tecnica a 2 conduttori)	DC 4...20 mA (ondulazione < 0,1 V mA a 5 °C di risoluzione) (ondulazione < 0,15 V a 1% di risoluzione)
	Tensione d'ingresso max.	DC 22 mA
	Resistenza d'ingresso nominale	160 Ohm
Alimentazione con protezione sull'inversione di polarità senza interruzione dagli ingressi dei segnali	Tensione d'esercizio U_s in riferimento a GND iso	DC 15...24 V
	Tensione d'esercizio max.	DC 25 V
	Assorbimento di corrente	12 mA a DC 24 V
Open Loop o Closed Loop	Funzione d'impostazione potenza	Grado d'impostazione OFF ... 100 %, scatti da 1%
	Funzione di regolazione temperatura	Preimpostazione valore nominale 50 °C ... 650 °C, scatti da 5 °C
Preimpostazione valore nominale Potenzimetro o interfaccia	Potenzimetro interno	Valore nominale OFF ... 100 % o 50 °C ... 650 °C
	Interfaccia esterna	Valore nominale OFF ... 100 % o 50 °C ... 650 °C

Descrizione dell'apparecchio

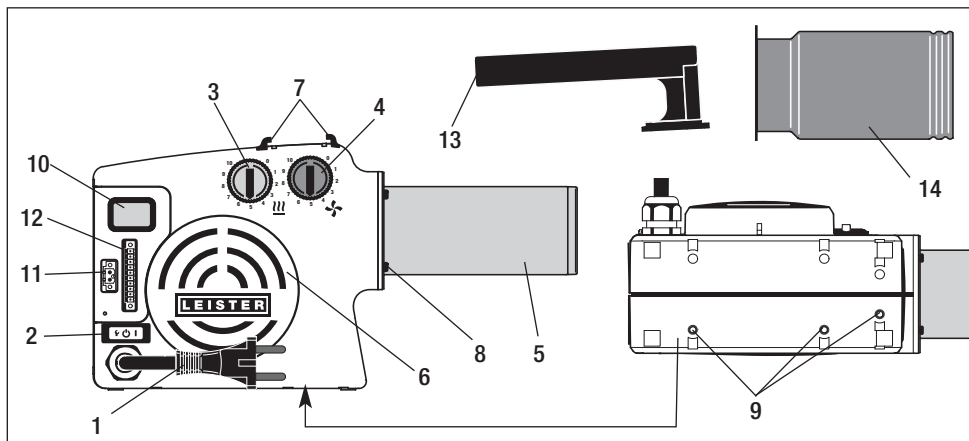

HOTWIND PREMIUM o SYSTEM

- 1 Linea di allacciamento alla rete
- 2 Interruttore principale con tasto funzione
- 3 Potenziometro per la temperatura (colore rosso)
- 4 Potenziometro per la portata d'aria (colore blu)
- 5 Tubo della resistenza
- 6 Flangia d'ingresso dell'aria per il filtro in acciaio inox
- 7 Supporto per l'impugnatura
- 8 Quattro viti di fissaggio
- 9 Tre innesti filettati M5 di fissaggio per l'installazione

HOTWIND SYSTEM

- 10 Display
- 11 Contatto di allarme
- 12 Interfaccia

Apparecchio portatile HOTWIND PREMIUM o SYSTEM

- 13 Impugnatura
- 14 Tubo di protezione

Funzionamento della protezione della resistenza e del dispositivo

- Se la resistenza o l'apparecchio si surriscalda (aria di aspirazione troppo calda o ristagno di calore), l'alimentazione della potenza alla resistenza viene interrotta e viene aperto il contatto di lavoro del relè d'allarme. Se il fusibile della resistenza o dell'apparecchio scatta, è necessario effettuare un reset di HOTWIND per motivi di sicurezza. Questa operazione è possibile premendo il **tasto funzione (2)**  per tre secondi. Verificare l'aria di aspirazione (vedere l'installazione).

Valori d'impostazione del potenziometro

- L'impianto elettronico interno limita la temperatura dell'aria in uscita a 650 °C.
- Si tratta di valori di riferimento che possono subire variazioni a causa delle condizioni ambiente e delle tolleranze dei componenti strutturali.

Posizione del potenziometro	0	1	2	3	4	5	6	7	8	9	10
Potenza di riscaldamento %	OFF	10	20	30	40	50	60	70	80	90	100
Portata d'aria l/min	200	270	340	410	480	550	620	690	760	830	900
Temperatura (3680 W) a 300 l/min °C	Ambiente	90	150	215	275	340	400	465	525	590	650

Schema temperatura - / portate d'aria

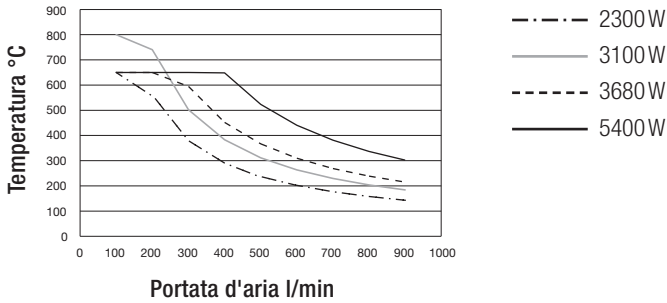

HOTWIND SYSTEM Interfaccia

11 Contatto di allarme

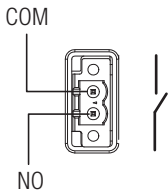

12 Interfaccia

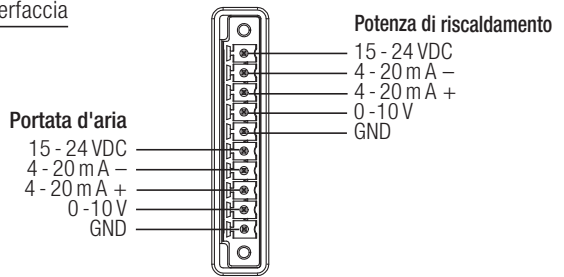

Nel collegamento alla rete deve essere presente un dispositivo adeguato per garantire la disconnessione di tutti i poli dalla rete con una **distanza dei contatti di 3 mm**.

Contatto di allarme: SPST-NO 250 VAC / 30 VDC, 3A $\cos \varphi = 1$

HOTWIND SYSTEM sistema di controllo

Input 0-10V

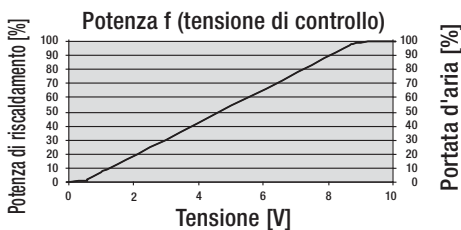
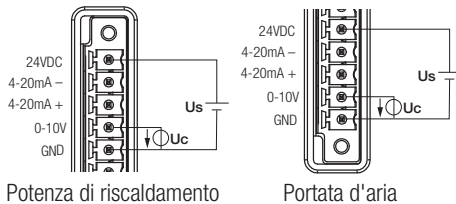

Input 4-20mA

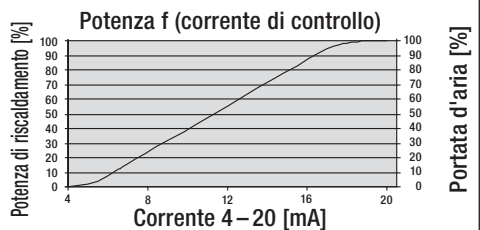
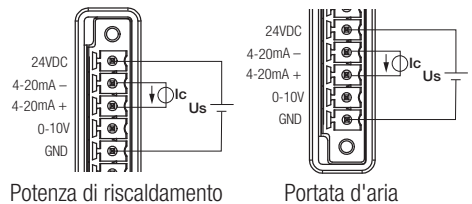

Attenzione: a 0 % la portata d'aria è pari a 200 l/min circa

Kit dell'impugnatura

- Il montaggio del kit dell'impugnatura è consentito solo a personale specializzato dotato di un'adeguata formazione o sotto la supervisione di quest'ultimo.
- L'**impugnatura (13)** e il **tubo di protezione (14)** non sono compresi nella fornitura (vedere gli accessori).



Prima del montaggio del kit dell'impugnatura, disattivare con l'**interruttore principale (2)** e lasciare raffreddare l'apparecchio. L'apparecchio si disattiva in modo automatico.



Scollegare la **linea di allacciamento alla rete (1)** dalla rete elettrica.

Montaggio del kit dell'impugnatura

- 1 Far scorrere l'**impugnatura (13)** sul **supporto (7)**.
- 2 Allentare le quattro **viti di fissaggio (8)** (non rimuoverle).
- 3 Far scorrere il **tubo di protezione (14)** sul **tubo della resistenza (5)** ed inserirlo nell'apertura per le **viti di fissaggio (8)**.
- 4 Ruotare il **tubo di protezione (14)** fino all'arresto.
- 5 Serrare le quattro **viti di fissaggio (8)**.



Sostituzione della resistenza

- La sostituzione della resistenza è consentita solo a personale specializzato dotato di un'adeguata formazione o sotto la supervisione di quest'ultimo.



Disattivare con l'**interruttore principale (2)** e lasciare raffreddare l'apparecchio. L'apparecchio si disattiva in modo automatico.



Scollegare la **linea di allacciamento alla rete (1)** dalla rete elettrica.

- 3 Rimuovere le quattro **viti di fissaggio (8)**.
- 4 Rimuovere il **tubo della resistenza (5)** e la resistenza.
- 5 Estrarre la resistenza dall'imballaggio.
- 6 Montare la resistenza e far scorrere il **tubo della resistenza (5)**.
- 7 Montare il **tubo della resistenza (5)** con **quattro viti di fissaggio (8)**.
- 8 Collegare la **linea di allacciamento (1)** alla rete elettrica. La tensione nominale specificata sull'apparecchio deve coincidere con la tensione di rete.

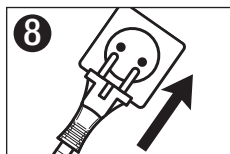
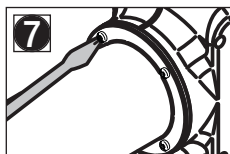
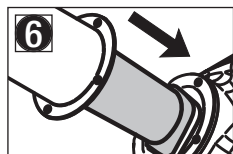
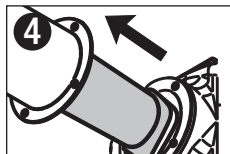
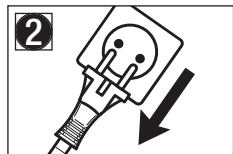
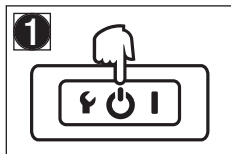

Sostituzione degli ugelli / del riflettore



Pericolo di ustione! Non toccare il tubo della resistenza e l'ugello quando sono ancora ad alte temperature. Per effettuare le operazioni di sostituzione degli ugelli o del riflettore, disattivare prima l'apparecchio con l'**interruttore principale (2)**  e lasciarlo raffreddare. L'apparecchio si disattiva in modo automatico.

Montaggio

- Il montaggio dell'apparecchio è consentito esclusivamente a personale specializzato.
- Per le dimensioni d'installazione vedere pagina 3.



Prima del montaggio dell'apparecchio, disattivare con l'**interruttore principale (2)**  e lasciare raffreddare l'apparecchio. L'apparecchio si disattiva in modo automatico.



Scollegare la **linea di allacciamento alla rete (1)** dalla rete elettrica.

- È obbligatorio accertarsi che le linee di allacciamento non vengano a contatto con il tubo della resistenza e non siano esposte al getto di aria calda.
- È obbligatorio fissare l'apparecchio con 3 viti M5 agli **innesti filettati (9)**.
- L'installazione deve garantire che
 - venga erogata solo aria fredda
 - non si formi un ristagno (di calore)
 - l'apparecchio non sia interessato da un getto di aria calda di un altro apparecchio.
- In presenza di aria che contenga polveri utilizzare il filtro in acciaio inox (vedere gli accessori) e farlo scorrere sulla **flangia d'ingresso dell'aria (6)**.
- In caso di polveri critiche, come ad esempio le polveri di metalli, quelle che conducono corrente elettrica o quelle umide, è necessario utilizzare filtri speciali per evitare eventuali cortocircuiti nell'apparecchio.
- Proteggere l'apparecchio da vibrazioni e sollecitazioni meccaniche.

Funzionamento

- A seconda delle esigenze montare l'ugello o il riflettore adeguato.



È necessario prestare attenzione al fatto che l'aria calda possa scorrere senza ostacoli perché altrimenti si potrebbero provocare danni all'apparecchio a causa della formazione di ristagni di calore (pericolo d'incendio).



Collegare la **linea di allacciamento (1)** alla rete elettrica. La tensione nominale specificata sull'apparecchio deve coincidere con la tensione di rete.

- Attivare l'**interruttore principale (2)** .



Dopo il funzionamento a caldo, disattivare con l'**interruttore principale (2)**  e lasciare raffreddare l'apparecchio. L'apparecchio si disattiva in modo automatico.



Scollegare la **linea di allacciamento alla rete (1)** dalla rete elettrica.

- **Attenzione!** In caso di impiego come apparecchiatura destinata all'installazione deve essere presente all'interno del collegamento alla rete un dispositivo adeguato **per garantire la disconnessione di tutti i poli** dalla rete con una **distanza dei contatti di 3 mm**.

Funzionamento di HOTWIND PREMIUM

- Impostare la **temperatura** con il **potenziometro (3)** rosso.
- Impostare la **portata d'aria** con il **potenziometro (4)** blu.

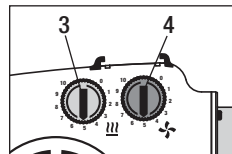

Funzionamento di HOTWIND SYSTEM

Potenziometro

- Impostare la **temperatura** con il **potenziometro (3)** rosso.
- Impostare la **portata d'aria** con il **potenziometro (4)** blu.

Interfaccia di sistema

- È possibile controllare la temperatura e la portata d'aria con l'**interfaccia di sistema (12)**. È possibile collegare l'allarme attraverso l'**uscita relè allarme (11)** dell'apparecchio.

Il **potenziometro della temperatura (3)** e il potenziometro della **portata d'aria (4)** non svolgono più nessuna funzione.

- Per la selezione del potenziometro o dell'interfaccia, vedere la configurazione a pagina 37.

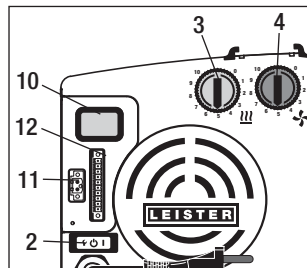

Display (10) HOTWIND SYSTEM

Nel menu Setup effettuare le impostazioni adeguate (vedere pagina 37).

• Regolazione interna (Closed Loop)

- Impostare la **temperatura** con il **potenziometro (3)** rosso.
- Impostare la **portata d'aria** con il **potenziometro (4)** blu.



Il display mostra il valore reale e nominale della temperatura.

Valore reale — 39.5
Valore nominale — 450 °C

• Regolazione esterna (Closed Loop)

- Impostare la **temperatura** utilizzando il **regolatore esterno**.
- Impostare la **portata d'aria** utilizzando il **regolatore esterno**.



Il display mostra il valore nominale della potenza in % e il valore reale della temperatura.

Valore reale — 490
Valore nominale % — 75P °C

• Sistema di controllo interno (Open Loop)

- Impostare il **valore nominale della potenza** con il **potenziometro (3)** rosso d'impostazione della temperatura.
- Impostare il **valore nominale della portata d'aria** utilizzando il **potenziometro (4)** blu.

• Sistema di controllo esterno (Open Loop)

- Impostare il **valore nominale della potenza** utilizzando il **regolatore esterno** d'impostazione della temperatura.
- Impostare il **valore nominale della portata d'aria** utilizzando il **regolatore esterno** d'impostazione della portata d'aria.

Configurazione e funzionamento di HOTWIND SYSTEM

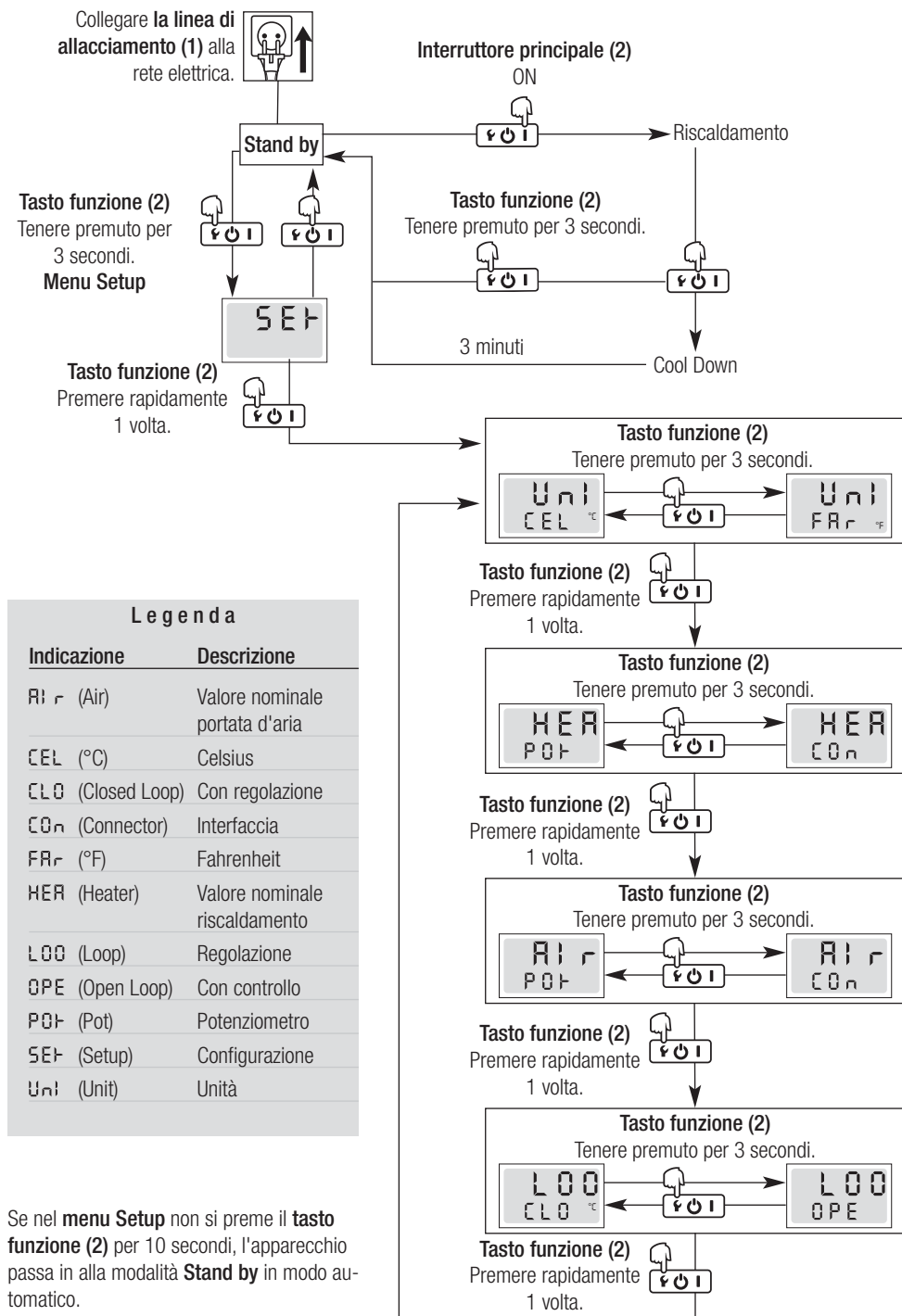

Errore

- Se si verifica un malfunzionamento dell'apparecchio, sul **display (10)** viene visualizzato un messaggio che presenta anche un codice d'errore. Questo codice fornisce una descrizione più dettagliata dell'errore (vedere la tabella).
- Premendo il **tasto funzione (2)**  per tre secondi è possibile eseguire il reset degli errori.

Display	Descrizione	Causa dell'errore	Risoluzione dell'errore
Err 01	Temperatura dell'apparecchio troppo elevata	Temperatura ambiente superiore alle specifiche	Ridurre la temperatura ambiente
		Temperatura dell'aria di alimentazione superiore alle specifiche	Ridurre la temperatura di alimentazione
		Ingresso dell'aria bloccato	Controllare l'ingresso dell'aria
		Filtro in acciaio inox bloccato	Pulire il filtro in acciaio inox
		Scarico dell'aria bloccato	Controllare lo scarico dell'aria
		Ugello errato montato	Controllare l'ugello
Err 02	Temperatura della resistenza troppo elevata	Ingresso dell'aria bloccato	Controllare l'ingresso dell'aria
		Filtro in acciaio inox bloccato	Pulire il filtro in acciaio inox
		Scarico dell'aria bloccato	Controllare lo scarico dell'aria
		Ugello errato montato	Sostituire l'ugello
Err 03	Sonda termica	Collegamento sonda termica errato	Controllare il collegamento della sonda termica
		Sonda termica difettosa	Contattare il centro di assistenza tecnica Leister
Err 04 Err 05 Err 06 Err 07 Err 08	Contattare il centro di assistenza tecnica Leister		

Accessori

- È consentito utilizzare solo gli accessori Leister.
Kit dell'impugnatura Cod. articolo 141.723
Filtro in acciaio inox Cod. articolo. 107.248
- Gli altri accessori sono disponibili all'indirizzo www.leister.com.

Formazione

- Leister Technologies AG e i rispettivi centri d'assistenza autorizzati offrono corsi di saldatura e di formazione gratuiti. Per maggiori informazioni consultare l'indirizzo www.leister.com.

Manutenzione

- In presenza di formazioni di sporco è necessario pulire l'**ingresso dell'aria (6)** con un pennello.
- Controllare la presenza di guasti elettrici e meccanici nella **linea di allacciamento alla rete (1)** e nella spina elettrica.

Servizio di assistenza e riparazione

- Le riparazioni devono essere eseguite esclusivamente dai **centri di assistenza tecnica Leister** autorizzati. I centri di assistenza tecnica garantiscono un **servizio di riparazione** professionale ed affidabile entro 24 ore con pezzi di ricambio originali conformi agli schemi elettrici e agli elenchi specifici.

Garanzia

- Questo apparecchio è coperto da una garanzia base di un (1) anno dalla data di acquisto (dimostrazione con fattura o bolla di consegna). In caso di danni la garanzia prevede la fornitura sostitutiva o la riparazione. Le resistenze sono escluse dalla garanzia.
- Sono esclusi altri eventuali diritti, salvo le disposizioni di legge.
- I danni, riconducibili alla naturale usura, al sovraccarico o alla scorretta manipolazione, vengono esclusi dalla garanzia.
- Non sono previsti eventuali diritti nei confronti degli apparecchi sottoposti a modifiche o alterazioni da parte dell'acquirente.

Nous vous félicitons pour votre achat de HOTWIND !

Vous avez choisi une soufflerie à chaud de premier choix du constructeur Leister, qui a été réalisée dans des matériaux de qualité supérieure. Chaque HOTWIND est soumis à un contrôle strict de qualité avant de quitter l'usine en Suisse.



Lisez attentivement la notice d'utilisation avant de mettre l'appareil en service et conservez-la à disposition pour une consultation ultérieure.

Soufflerie à air chaud HOTWIND PREMIUM, HOTWIND SYSTEM

Application

La soufflerie à chaud HOTWIND PREMIUM et le système HOTWIND sont conçus pour une utilisation en continu. Ils conviennent parfaitement au montage dans des machines, installations et appareils et peuvent aussi être utilisés comme appareils manuels et appareils de table.

Parmi leurs principales applications, on peut citer le séchage, le durcissement, la décongélation, l'accélération, la dissolution, la stérilisation, le polissage, le lustrage, l'activation et la dissolution, le décollement et le soudage, la mise sous vide, le brasage, le soudage, l'ébavurage et l'allumage.



Avertissement



Danger de mort à l'ouverture de l'appareil, car des composants et des liaisons sous tension sont découverts. Avant d'ouvrir l'appareil, retirez la fiche secteur de la prise de courant.



Risque d'incendie et d'explosion en cas d'utilisation non conforme de décapeurs thermiques, en particulier à proximité de matériaux inflammables et de gaz explosifs.



Risque de brûlure ! Ne touchez pas le tuyau de la résistance et la buse s'ils sont chauds. Laissez refroidir l'appareil.
Ne dirigez pas le jet d'air chaud sur les personnes ou les animaux.



Attention



La tension nominale indiquée sur l'appareil doit correspondre à la tension du secteur. EN 61000-3-11; $Z_{max} = 0.053 \Omega + j 0.033 \Omega$. Le cas échéant, consultez l'entreprise de distribution d'électricité.



Un **interrupteur FI** est absolument nécessaire pendant l'utilisation de l'appareil sur des chantiers pour assurer la protection des personnes.



L'appareil doit fonctionner **sous supervision**. La chaleur peut atteindre des matériaux inflammables se trouvant hors de portée de vue.

L'appareil doit être utilisé exclusivement par des **spécialistes formés** ou sous leur supervision. L'utilisation de l'appareil par des enfants est strictement interdite.



Protégez l'appareil de l'humidité et de la pluie.

Déclaration d'incorporation

(Selon la Directive Machines 2006/42/CE ; Annexe II B)

Par la présente, **Leister Technologies AG, Galileo-Strasse 10, CH-6056 Kaegiswil/Suisse** déclare que la quasi-machine

Désignation : **Hot air blower**
Type : **HOTWIND**
Modèle : **PREMIUM ou SYSTEM**

– dans la mesure où l'étendue de livraison le permet – est conforme aux exigences essentielles applicables de la directive Machines (2006/42/CE).

La quasi-machine satisfait en outre aux exigences de la/des directive(s) suivante(s) :

Directive(s) CE : Compatibilité électromagnétique 2004/108
Directive Basse Tension 2006/95

Harmonisierte Normen: EN 12100-1, EN 12100-2, EN 60204-1, EN 14121-1,
EN 55014-1, EN 55014-2, EN 61000-6-2,
EN 61000-3-2, EN 61000-3-3, EN 61000-3-11 (Z_{max})
EN 50366, EN 62233, EN 60335-2-45

De plus, nous confirmons également que la documentation technique spécifique à cette quasi-machine a été préparée conformément à l'Annexe VII (Partie B) et nous nous engageons à la remettre aux autorités de surveillance du marché par voie électronique.

Nom du responsable de la documentation : Patrick Rieder, Responsable de la conformité

La mise en service de cette quasi-machine est interdite tant qu'il n'a pas été constaté que la machine dans laquelle elle doit être incorporée est conforme aux dispositions de la directive Machines (2006/42/CE).

Kaegiswil, 28.11.2011

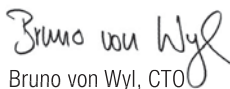
Bruno von Wyl, CTO

Beat Mettler, COO

Elimination



Les appareils électriques, accessoires et emballages doivent être recyclés dans le respect de l'environnement. Uniquement pour les pays européens: Ne jetez pas les appareils électriques dans les déchets ménagers! Conformément à la directive européenne 2002/96 relative aux déchets d'équipements électriques et électroniques et à son application au droit national, les appareils électriques usagés doivent être collectés séparément et recyclés dans le respect de l'environnement.

Caractéristiques techniques

Tension	V~	120	230	230	230	400
Puissance	W	2300	2300	3100	3680	5400
Fréquence	Hz	50/60				
Température maximum de sortie d'air	°C	650	650	800	650	650
Quantité d'air (20 °C)	l/min.	200 – 900				
Pression statique maximum	Pa	820	1050			
Niveau d'émission	L_{pA} (dB)	< 70				
Poids	kg	2.2	2.2	2.3	2.2	2.4
Sans câble d'alimentation secteur						
Dimensions	Page 3 (Dimensions)					
Signe de conformité	CE					
Signe de protection						
Type de certification						
Classe de protection II	□					
Sous réserve de modifications techniques						
Tension d'alimentation non réversible						

	PREMIUM	SYSTEM
Puissance calorifique et débit d'air réglables en continu avec potentiomètre	•	•
Électronique de puissance intégrée	•	•
Protection contre la surchauffe de l'élément chauffant et de l'appareil	•	•
Emission alarme		•
Régulateur de température intégré		•
Interface de télécommande pour le paramétrage de température et de puissance		•
Interface de télécommande pour le paramétrage de débit d'air		•
Sonde de température intégrée		•
Affichage des valeurs de consigne et valeurs effectives (°C ou °F)		•

Caractéristiques techniques de l'interface

PREMIUM, SYSTEM Sortie relais	Tensions maxi	AC 250 V, DC 30 V
	Courants maxi	AC 3 A, DC 3 A
	Résistance de contact maxi	100 m Ohm pour DC 6 V / 1 A
	Type de contact	SPST - NO
	Isolation IEC/EN 60065	AC 2000 V (50 - 60 Hz) 1 min
SYSTEM Entrées de signal Avec protection contre l'inversion de polarité et Compensation de décalage de zéro	Isolation IEC/EN 60747-5-2	AC 1414 V Peak
	Entrée de tension U_c référencée à GND iso	DC 0 - 10 V (fluctuation < 0.05 V pour résolution 5 °C) (fluctuation < 0.1 V pour résolution 1 %)
	Tension d'entrée maxi	DC 12 V
	Résistance nominale d'entrée	280 kOhm
	Entrée courant I_c (2 - technique conducteur)	DC 4...20 mA (fluctuation < 0.1 mA pour résolution 5 °C) (fluctuation < 0.15 mA pour résolution 1 %)
	Courant d'entrée maxi	DC 22 mA
	Résistance nominale d'entrée	160 Ohm
Alimentation Avec protection contre l'inversion de polarité Sans séparation des entrées de signal	Tension de fonctionnement U_s référencée à GND iso	DC 15...24 V
	Tension de fonctionnement maxi	DC 25 V
	Consommation de courant	12 mA pour DC 24 V
Open Loop ou Closed Loop	Fonction de déclenchement puissance	Taux de régulation OFF...100 %; Par pas de 1 %
	Fonction de régulation température	Paramétrage valeur de consigne 50 °C...650 °C, Par pas de 5 °C
Paramétrage valeur de consigne Potentiomètre ou interface	Potentiomètre interne	Valeur de consigne OFF...100 % ou 50 °C ...650 °C
	Interface externe	Valeur de consigne OFF...100 % ou 50 °C ...650 °C

Description de l'appareil

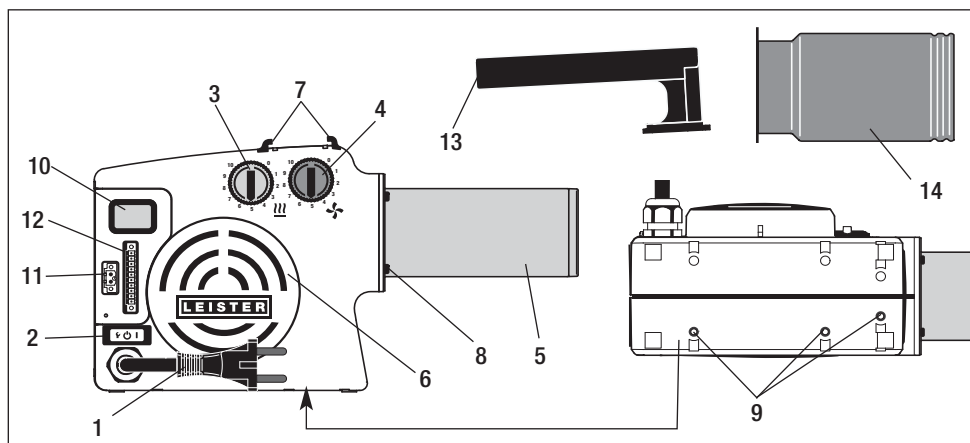

HOTWIND PREMIUM ou SYSTEM

- 1 Câble d'alimentation secteur
- 2 Commutateur principal avec touche de fonction
- 3 Potentiomètre pour la température (rouge)
- 4 Potentiomètre pour le débit d'air (bleu)
- 5 Tuyau de la résistance
- 6 Entrée d'air pour le filtre en acier
- 7 Fixation pour poignée
- 8 Quatre vis de fixation
- 9 Trois inserts filetés M5 pour la fixation
Pour le montage

HOTWIND SYSTEM

- 10 Ecran
- 11 Contact d'alarme
- 12 Interface

Appareil manuel HOTWIND PREMIUM ou SYSTEM

- 13 Poignée
- 14 Tube de protection

Fonction de protection de l'élément chauffant et de l'appareil

- En cas de surchauffe de l'élément chauffant ou de l'appareil (air d'aspiration trop chaud ou échauffement), l'apport de puissance vers la résistance est interrompu et le contact de travail du relais d'alarme est ouvert. Si la protection de la résistance ou de l'appareil est activée, une réinitialisation (reset) du HOTWIND est requise pour des raisons de sécurité. La réinitialisation s'effectue en appuyant sur la **touche de fonction (2)** pendant trois secondes. Contrôle de l'air d'aspiration (voir montage).



Valeurs de réglage du potentiomètre

- L'électronique interne limite la température maximale de sortie d'air à 650 °C.
- Il s'agit de valeurs indicatives qui peuvent varier en fonction des conditions environnementales et des tolérances des composants.

Potentiomètre Position	0	1	2	3	4	5	6	7	8	9	10
Puissance de chauffe %	OFF	10	20	30	40	50	60	70	80	90	100
Quantité d'air l/min	200	270	340	410	480	550	620	690	760	830	900
Température (3680 W) Pour 300 l/min °C	Environnement	90	150	215	275	340	400	465	525	590	650

Diagramme Température / débit d'air

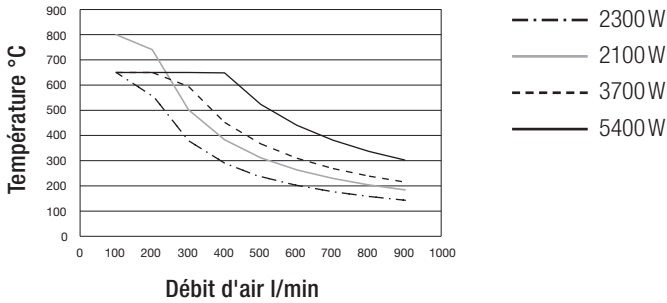

HOTWIND SYSTEM

Interface

11 Contact d'alarme

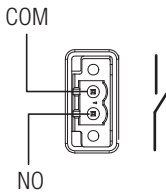

12 Interface

Quantité d'air

15 - 24 VDC
4 - 20 mA -
4 - 20 mA +
0 - 10 V
GND

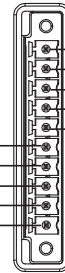

Puissance de chauffe

15 - 24 VDC
4 - 20 mA -
4 - 20 mA +
0 - 10 V
GND

Un dispositif adéquat de séparation du secteur sur tous les pôles doit être présent dans la connexion secteur, avec une **distance entre contacts de 3 mm**.

Contact d'alarme : SPST-NO 250 VAC / 30 VDC, 3A $\cos \varphi = 1$

Commande du système HOTWIND SYSTEM

Input 0-10V

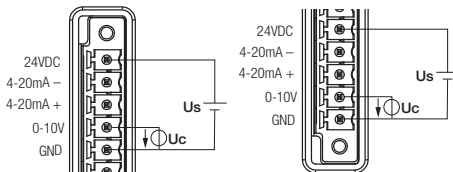

Puissance de chauffe

Quantité d'air

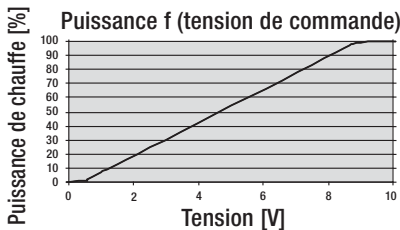

Input 4-20mA

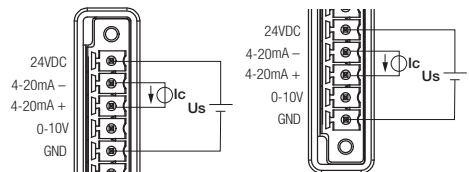

Puissance de chauffe

Quantité d'air

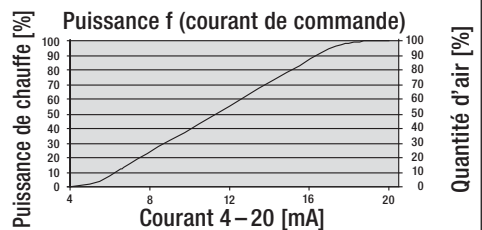

Attention : Pour une quantité d'air de 0% environ 200 l/min

Kit poignée

- Le montage du kit poignée doit être effectué exclusivement par des spécialistes formés ou sous leur supervision.
- **Poignée (13)** et **fourreau de protection (14)** ne sont pas compris dans le contenu de la livraison (voir accessoires).



Avant le montage du kit poignée, mettre l'appareil hors tension au moyen du **commutateur principal** (2) et le laisser refroidir. L'appareil s'éteint automatiquement.





Débranchez le **câble d'alimentation (1)** du secteur électrique.

Montage du kit poignée

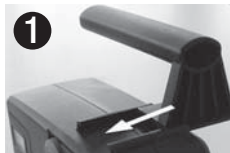
- 1 Poussez la **poignée (13)** sur la **fixation (7)**.
- 2 Desserrez les quatre **vis de fixation (8)** sans les retirer complètement.
- 3 Poussez le **fourreau de protection (14)** sur le **tuyau de la résistance (5)** et introduisez-le dans l'ouverture pour les **vis de fixation (8)**.
- 4 Tournez le **fourreau de protection (14)** jusqu'à la butée.
- 5 Serrez les quatre **vis de fixation (8)**.



Remplacement de l'élément chauffant

- Le remplacement de l'élément chauffant doit être effectué exclusivement par des spécialistes formés ou sous leur supervision.
- 1  Basculez le **commutateur principal** (2) en position Arrêt et laissez refroidir l'appareil. L'appareil s'éteint automatiquement.
 - 2  Débranchez le **câble d'alimentation (1)** du secteur électrique.
 - 3 Retirez les quatre **vis de fixation (8)**. 4 Retirez le **tuyau de la résistance (5)** et l'élément chauffant.
 - 5 Sortez le nouvel élément chauffant de son emballage. 6 Montez l'élément chauffant et poussez le **tuyau de la résistance (5)**.
 - 7 Montez le **tuyau de la résistance (5)** à l'aide des **quatre vis de fixation (8)**.
 - 8  Raccordez le **câble d'alimentation secteur (1)** au secteur électrique. La tension nominale indiquée sur l'appareil doit correspondre à la tension du secteur.

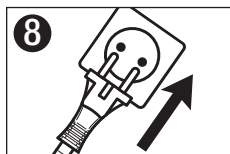
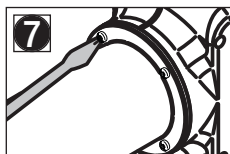
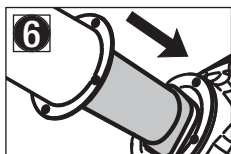
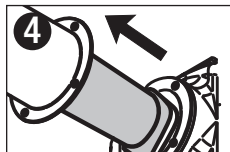
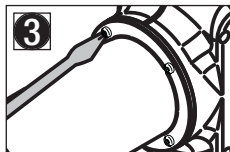
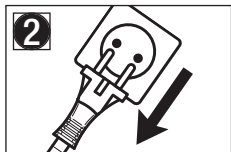
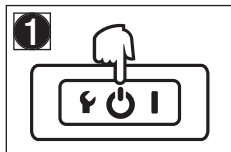

Remplacement de buses / réflecteurs



Risque de brûlure ! Ne touchez pas le tuyau de la résistance et la buse s'ils sont chauds.

Avant le remplacement de la buse ou du réflecteur, commencez par basculer le **commutateur**

principal (2)  en position Arrêt et laissez refroidir l'appareil. L'appareil s'éteint automatiquement.



Montage

- L'appareil doit être monté exclusivement par des spécialistes formés à cet effet.
- Dimensions de montage, voir page 3, Dimensions / Size.



Avant le montage, basculez le **commutateur principal (2)**  en position Arrêt et laissez refroidir l'appareil. L'appareil s'éteint automatiquement.



Débranchez le **câble d'alimentation (1)** du secteur électrique.

- Assurez-vous que les câbles d'alimentation ne touchent pas le tuyau de la résistance et qu'ils ne sont pas exposés au jet d'air chaud.
- L'appareil doit être fixé au moyen de trois vis M5 sur les **inserts filetés (9)**.
- Le montage doit garantir
 - que seul de l'air froid est introduit
 - qu'aucun échauffement ne se produit
 - que le jet d'air chaud d'un autre dispositif ne balaye pas l'appareil.
- Si l'air est chargé de poussières, utilisez un filtre en acier inoxydable (voir Accessoires) au niveau de **l'entrée d'air (6)**.
- Si les poussières sont particulièrement critiques (par exemple poussières métalliques, électroconductrices ou humides), des filtres spéciaux doivent être utilisés pour éviter des courts-circuits dans l'appareil.
- Protégez l'appareil des vibrations mécaniques et des secousses.

Fonctionnement

- Selon les besoins, montez la buse ou le réflecteur correspondant.



Vérifiez que l'air chaud puisse s'échapper librement, auquel cas l'appareil peut être endommagé en raison d'un échauffement (risque d'incendie !).



Raccordez le **câble d'alimentation secteur (1)** au secteur électrique. La tension nominale indiquée sur l'appareil doit correspondre à la tension du secteur.

- Basculez le **commutateur principal (2)**  en position Marche



Après le fonctionnement du chauffage, basculez le **commutateur principal (2)**  en position Arrêt et laissez refroidir l'appareil. L'appareil s'éteint automatiquement.



Débranchez le **câble d'alimentation (1)** du secteur électrique.

- **ATTENTION** : Dans le cas d'une utilisation en tant qu'appareil intégré, un dispositif adéquat de séparation du secteur **sur tous les pôles** doit être présent dans la connexion secteur, avec une **distance entre contacts de 3 mm**.

Utilisation de HOTWIND PREMIUM

- Réglez la **température** à l'aide du **potentiomètre rouge (3)**.
- Réglez la **quantité d'air** à l'aide du **potentiomètre bleu (4)**.

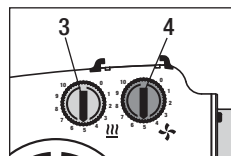

Utilisation de HOTWIND SYSTEM

Potentiomètre

- Réglez la **température** à l'aide du **potentiomètre rouge (3)**.
- Réglez la **quantité d'air** à l'aide du **potentiomètre bleu (4)**.

Interface système

- La température et la quantité d'air peuvent être commandées au moyen de l'**interface système (12)**. L'alarme peut être raccordée via la **sortie relais d'alarme (11)** de l'appareil.

Le **potentiomètre de réglage de la température (3)** et le **potentiomètre de réglage de la quantité d'air (4)** n'ont plus de fonction.

- Pour passer du potentiomètre à l'interface ou inversement, voir Configuration en page 49.

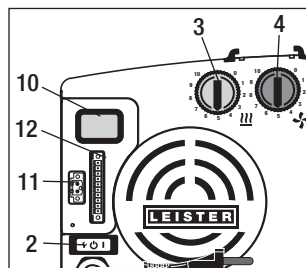

Ecran (10) HOTWIND SYSTEM

Dans le menu Setup, entrez les paramètres correspondants (voir Page 49).

- **Régulation interne (Closed Loop)**
 - Réglez la **température** à l'aide du **potentiomètre rouge (3)**.
 - Réglez la **quantité d'air** à l'aide du **potentiomètre bleu (4)**.
- **Régulation externe (Closed Loop)**
 - Réglez la **température** à l'aide du **régulateur externe**.
 - Réglez la **quantité d'air** à l'aide du **régulateur externe**.



L'écran affiche la valeur effective et la valeur de consigne de la température

Valeur effective — 395
Valeur de consigne — 450 °C

- **Commande interne (Open Loop)**
 - Réglez la **valeur de consigne de puissance** à l'aide du **potentiomètre rouge (3)** pour la température.
 - Réglez la **valeur de consigne de la quantité d'air** au moyen du **potentiomètre bleu (4)** pour la quantité d'air.
- **Commande externe (Open Loop)**
 - Réglez la **valeur de consigne de puissance** au moyen du **régulateur externe** pour la température.
 - Réglez la **valeur de consigne de la quantité d'air** au moyen du **régulateur externe** pour la quantité d'air.



L'écran affiche la valeur de consigne en % et la valeur effective de la température

Valeur effective — 490
Valeur de consigne % — 75P °C

Configuration et utilisation de HOTWIND SYSTEM

Raccordez le **câble d'alimentation secteur (1)** au secteur électrique



Commutateur principal (2)
MARCHÉ



Chauffage

Touche de fonction (2)
Appuyez pendant 3 secondes



3 minutes

Cool Down

Touche de fonction (2)
Appuyez pendant 3 secondes
Menu Setup

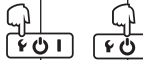

Touche de fonction (2)
1 appui court sur la touche



Touche de fonction (2)

Appuyez pendant 3 secondes

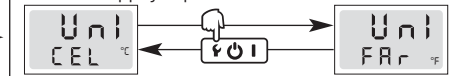

Touche de fonction (2)
1 appui court sur la touche



Touche de fonction (2)

Appuyez pendant 3 secondes

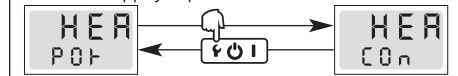

Touche de fonction (2)
1 appui court sur la touche



Touche de fonction (2)

Appuyez pendant 3 secondes

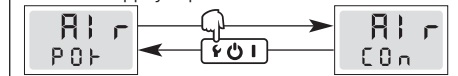

Touche de fonction (2)
1 appui court sur la touche



Touche de fonction (2)

Appuyez pendant 3 secondes

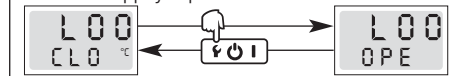

Touche de fonction (2)
1 appui court sur la touche



Légende

Affichage	Description
RI r (Air)	Consigne quantité d'air
CEL (°C)	Celsius
CLO (Closed Loop)	Régulé
CON (Connector)	Interface
FAr (°F)	Fahrenheit
HEA (Heater)	Consigne chauffage
LOO (Loop)	Régulation
OPE (Open Loop)	Piloté
POT (Pot)	Potentiomètre
SET (Setup)	Configuration
Unit (Unit)	Unité

Si dans la **touche de fonction (2)** n'est pas maintenue enfoncée pendant 10 secondes dans le **menu Setup**, l'appareil passe automatiquement en mode **Stand by**.

Erreur

- En cas de défaut de fonctionnement de l'appareil, un message s'affiche sur l'**écran (10)** avec un code d'erreur. Ce code fait référence à une description détaillée de l'erreur (voir tableau).
- Suite à une erreur, une réinitialisation (Reset) peut être effectuée en appuyant sur la **touche de fonction (2)** pendant trois secondes.



Écran	Désignation	Origine de l'erreur	Élimination de l'erreur
Err 01	Température appareil trop élevée	Température environnante supérieure à la température spécifiée	Réduire la température environnante
		Température d'entrée d'air supérieure à la température spécifiée	Réduire la température d'entrée d'air
		Entrée d'air bloquée	Contrôler l'entrée d'air
		Filtre en acier bloqué	Nettoyer le filtre en acier
		Sortie d'air bloquée	Contrôler la sortie d'air
		Mauvaise buse montée	Contrôler la buse
Err 02	Température résistance trop élevée	Entrée d'air bloquée	Contrôler l'entrée d'air
		Filtre en acier bloqué	Nettoyer le filtre en acier
		Sortie d'air bloquée	Contrôler la sortie d'air
		Mauvaise buse montée	Remplacer la buse
Err 03	Sonde de température	Raccordement sonde de température défectueux	Contrôler le raccordement de la sonde de température
		Sonde de température défectueuse	Contacteur le service après-vente Leister
Err 04 Err 05 Err 06 Err 07 Err 08	Contacter le service après-vente Leister		

Accessoires

- **Seuls des accessoires Leister doivent être utilisés.**

Kit poignée Réf. article 141.723

Filtre en acier Réf. article 107.248

- Autres accessoires à l'adresse www.leister.com

Formation

- Leister Technologies AG et ses SAV compétents proposent des cours et des formations gratuits. Informations à l'adresse www.leister.com.

Entretien

- En cas de salissure, l'**entrée d'air (6)** doit être nettoyée au pincée.
- Contrôlez le **câble d'alimentation secteur (1)** et la fiche pour détecter tout éventuel dommage électrique ou mécanique.

Maintenance et réparation

- Les réparations doivent être réalisées exclusivement par les **SAV Leister** compétents. Ils garantissent un **service de réparation** approprié et fiable, dans les délais prévus, avec des pièces détachées d'origine, conformément aux schémas de câblage et aux listes des pièces de rechange.

Garantie

- L'appareil est couvert par une garantie de base d'un (1) an à compter de la date d'achat (prouvée grâce à la facture ou au bon de livraison). Une livraison de remplacement ou des réparations permettent de corriger les dommages survenus. Les résistances sont exclues de cette garantie.
- Toute autre prétention est exclue, sous réserve des dispositions légales applicables.
- Les dommages imputables à l'usure naturelle, à une surcharge ou à une manipulation non conforme sont exclus de la garantie.
- Toute prétention est exclue pour les appareils qui ont été transformés ou modifiés par l'acheteur.

¡Le damos la enhorabuena por la compra de HOTWIND!

Usted se ha decidido por un soplante de aire caliente de primera clase de la casa Leister, compuesto por materiales de excelente calidad. Todos los HOTWIND se someten a un estricto control de calidad antes de salir de la fábrica de Suiza.



Lea atentamente las instrucciones de funcionamiento antes de la puesta en marcha y consérvelas para usos futuros.

Soplante de aire caliente HOTWIND PREMIUM, HOTWIND SYSTEM

Aplicación

Los soplantes de aire caliente HOTWIND PREMIUM y HOTWIND SYSTEM han sido diseñados para el funcionamiento continuo. Son ideales para su montaje en máquinas, instalaciones y aparatos, pero también como aparatos manuales o de mesa.

Sus aplicaciones más importantes son, por ejemplo, el secado y el calentamiento, el descongelamiento, la aceleración y disolución, la esterilización, el alisado, el abrillantamiento, la activación y el desprendimiento, la separación y fundición, el retractilado, las soldaduras, el desbarbado o el encendido.



Advertencia



Peligro de muerte al abrir el aparato, ya que se dejan al descubierto componentes y conexiones sometidos a tensión. Antes de abrir el equipo, desconecte el enchufe.



Peligro de fuego y explosiones en caso de un uso inadecuado de los dispositivos de aire caliente, en especial cerca de materiales inflamables y gases explosivos.



¡Peligro de quemaduras! No toque el tubo del elemento calentador ni la boquilla si están calientes. Espere a que el equipo se enfríe. No dirija el chorro de aire caliente hacia personas o animales.



Precaución



La tensión nominal indicada en el aparato debe coincidir con la tensión de red. EN 61000-3-11; $Z_{max} = 0.053 \Omega + j 0.033 \Omega$. En caso necesario, consulte a la empresa de suministro eléctrico.



En el trabajo de obra, es imprescindible el uso de un **interruptor FI** para la protección personal.



El equipo **debe permanecer vigilado** mientras esté funcionando. El calor puede llegar a materiales inflamables que se encuentren fuera del ámbito visual.

El aparato sólo podrá ser utilizado **por personal especializado** debidamente formado o bajo su vigilancia. Se prohíbe terminantemente su uso por parte de niños.



Proteger el aparato de la **humedad y el agua**.

Declaración de montaje

(a efectos de la directiva sobre máquinas de la CE 2006/42, anexo II B)

Por la presente, **Leister Technologies AG, Galileo-Strasse 10, CH-6056 Kaegiswil / Suiza** declara que la máquina incompleta

Denominación: **Hot air blower**
Tipo: **HOTWIND**
Modelo: **PREMIUM o SYSTEM**

– cumple las exigencias fundamentales aplicables de la directiva sobre máquinas de la CE (2006/42), en la medida en que el volumen de suministro lo permita.

La máquina incompleta cumple además las exigencias de la(s) siguiente(s) directiva(s) de la CE:

Directiva(s) de la CE: Compatibilidad electromagnética 2004/108
Directiva de baja tensión 2006/95

Normas armonizadas: EN 12100-1, EN 12100-2, EN 60204-1, EN 14121-1,
EN 55014-1, EN 55014-2, EN 61000-6-2,
EN 61000-3-2, EN 61000-3-3, EN 61000-3-11 (Z_{max})
EN 50366, EN 62233, EN 60335-2-45

Aparte declaramos que la documentación técnica especial para esta máquina incompleta se ha elaborado según el anexo VII (parte B) y nos comprometemos a transmitirla por vía electrónica a las autoridades de control de mercado cuando se nos solicite justificadamente.

Nombre del responsable de la documentación: Patrick Rieder, Compliance Manager

La puesta en funcionamiento de la máquina incompleta queda prohibida hasta que, en caso necesario, se constate que la máquina en la que esta máquina incompleta se ha instalado cumple las disposiciones de la directiva sobre máquinas de la CE (2006/42).

Kaegiswil, 28.11.2011

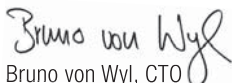
Bruno von Wyl, CTO

Beat Mettler, COO

Eliminación



Los equipos eléctricos, accesorios y embalajes deben ser reciclados ecológicamente. Solo para países de la UE: ¡No tire equipos eléctricos a la basura! Según la directiva europea 2002/96 sobre residuos de aparatos eléctricos y electrónicos y su aplicación en derecho nacional, los equipos eléctricos que ya no se pueden usar deben ser recogidos por separado y reciclados ecológicamente.

Datos técnicos

Tensión	V~	120	230	230	230	400
Potencia	W	2300	2300	3100	3680	5400
Frecuencia	Hz	50/60				
Temperatura máx. de salida de aire	°C	650	650	800	650	650
Caudal de aire (20 °C)	l/min.	200 – 900				
Presión estática máx.	Pa	820	1050			
Nivel de emisiones	L_{pA} (dB)	< 70				
Peso sin cable de conexión de red	kg	2.2	2.2	2.3	2.2	2.4
Dimensiones	Página 3 (Tamaño)					
Símbolo de conformidad	CE					
Símbolo de seguridad						
Tipo de certificado						
Clase de protección II	□					
Sujeto a modificaciones técnicas						
Tensión de alimentación no conmutable						

	PREMIUM	SYSTEM
Potencia de calentamiento y caudal de aire regulables sin escalas mediante potenciómetro	•	•
Electrónica de potencia integrada	•	•
Protección contra el sobrecalentamiento del elemento calentador y del aparato	•	•
Salida de alarma		•
Regulador de temperatura integrado		•
Interfaz de control remoto para la especificación de temperatura o potencia		•
Interfaz de control remoto para la especificación del caudal de aire		•
Sonda de temperatura integrada		•
Indicador del valor nominal y real (°C o °F)		•

Datos técnicos de las interfaces

PREMIUM, SYSTEM Salida de relés	Tensiones máx.	AC 250 V, DC 30 V
	Corrientes máx.	AC 3 A, DC 3 A
	Resistencia de contacto máx.	100 m Ohm con DC 6 V / 1 A
	Tipo de contacto	SPST - NO
	Aislamiento IEC/EN 60065	AC 2000 V (50 - 60 Hz) 1 min
SYSTEM Entradas de señal con protección contra polaridad incorrecta y corrección del punto cero.	Aislamiento IEC/EN 60747-5-2	AC 1414 V Peak
	Entrada de tensión U_c en relación a GND iso	DC 0 - 10 V (Rippel < 0,05 V con resolución 5 °C) (Rippel < 0,1 V con resolución 1 %)
	Tensión de entrada máxima	DC 12 V
	Resistencia de entrada nominal	280 kOhm
	Entrada de corriente I_c (técnica 2 conductores)	DC 4...20 mA (Rippel < 0,1 mA con resolución 5 °C) (Rippel < 0,15 mA con resolución 1 %)
	Entrada de corriente máx.	DC 22 mA
	Resistencia de entrada nominal	160 Ohm
Alimentación con protección contra polaridad incorrecta sin separación de las entradas de señal	Tensión de funcionamiento U_s en relación a GND iso	DC 15...24 V
	Tensión de funcionamiento máx.	DC 25 V
	Consumo de corriente	12 mA con DC 24 V
Open Loop o Closed Loop	Función de ajuste potencia	Grado de ajuste OFF...100 %; Pasos 1%
	Función de regulación temperatura	Especificación valor nominal 50 °C...650 °C, pasos 5 °C
Especificación valor nominal potenciómetro o interfaz	Potenciómetro interno	Valor nominal OFF...100 % o 50 °C...650 °C
	Interfaz externa	Valor nominal OFF...100 % o 50 °C...650 °C

Descripción del aparato

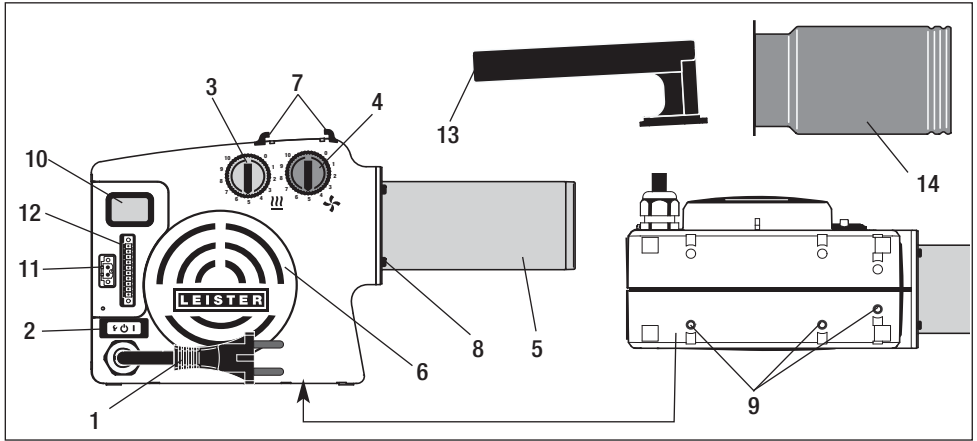

HOTWIND PREMIUM o SYSTEM

- 1 Cable de conexión de red
- 2 Interruptor principal con tecla de función
- 3 Potenciómetro para la temperatura (rojo)
- 4 Potenciómetro para el caudal de aire (azul)
- 5 Tubo del elemento calentador
- 6 Brida de entrada de aire para filtros de acero inoxidable
- 7 Soporte para el mango
- 8 Cuatro tornillos de fijación
- 9 Tres insertos roscados M5 de fijación para el montaje

HOTWIND SYSTEM

- 10 Pantalla
- 11 Contacto de alarma
- 12 Interfaz

Aparato manual HOTWIND PREMIUM o SYSTEM

- 13 Mango
- 14 Tubo protector

Función de protección del elemento calentador y del aparato

- Si el elemento calentador o el aparato se sobrecalienta (aire de aspiración demasiado caliente o retención de aire caliente), se interrumpe la alimentación de potencia al elemento calentador y se abre el contacto de trabajo del relé de alarma. Si se activa la protección del elemento calentador o del aparato, por motivos de seguridad será necesario reiniciar (reset) el HOTWIND. Esto se lleva a cabo pulsando la **tecla de función (2)** durante tres segundos. Compruebe el aire de aspiración (consulte Montaje).



Valores de ajuste del potenciómetro

- El sistema electrónico interno establece la temperatura máxima de salida de aire en 650 °C.
- Se trata de valores de referencia que pueden variar según las condiciones ambientales y las tolerancias de las piezas.

Posición del potenciómetro	0	1	2	3	4	5	6	7	8	9	10
Potencia de calentamiento %	OFF	10	20	30	40	50	60	70	80	90	100
Caudal de aire l/min	200	270	340	410	480	550	620	690	760	830	900
Temperatura (3680 W a 300 l/min) °C	Ambiente	90	150	215	275	340	400	465	525	590	650

Diagrama de temperatura / caudal de aire

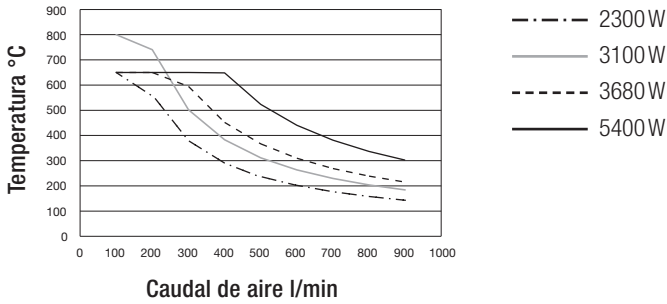

HOTWIND SYSTEM

Interfaz

11 Contacto de alarma

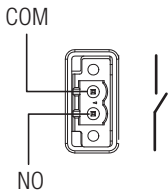

12 Interfaz

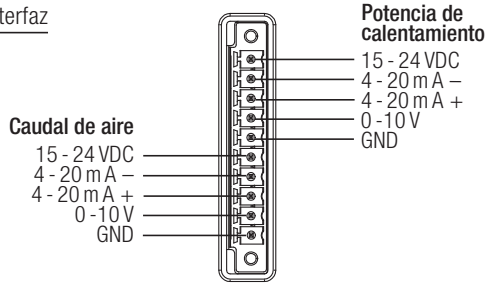

La conexión de red debe disponer de un dispositivo adecuado que asegure la completa desconexión de la red con una **distancia de contacto de 3 mm**.

Contacto de alarma: SPST-NO 250 VAC / 30 VDC, 3 A $\cos \phi = 1$

Control del HOTWIND SYSTEM

Input 0-10 V

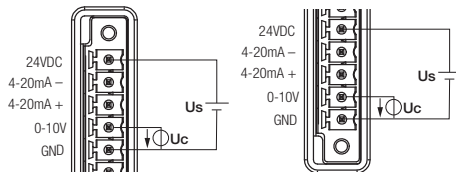

Potencia de calentamiento

Caudal de aire

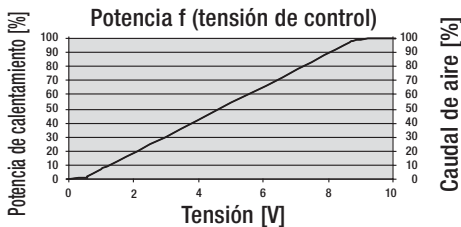

Input 4-20 mA

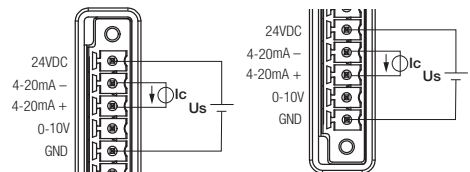

Potencia de calentamiento

Caudal de aire

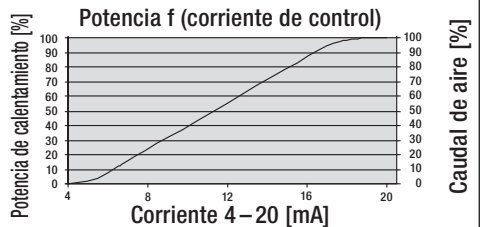

Atención: Caudal de aire del 0 % aprox. 200 l/min.

Kit de mango

- El montaje del kit de mango sólo debe ser realizado por personal especializado debidamente formado o bajo su supervisión.
- El **mango (13)** y el **tubo protector (14)** no están incluidos en el volumen de suministro (consulte Accesorios).



Antes del montaje del kit de mango, apague el aparato con el **interruptor principal (2)**  y déjelo enfriar. El aparato se desconecta automáticamente.



Desconecte el **cable de conexión de red (1)** de la red eléctrica.



Montaje del kit de mango

- 1 Encaje el **mango (13)** en el **soporte (7)**.
- 2 Afloje (sin retirar) los cuatro **ornillos de fijación (8)**.
- 3 Deslice el **tubo protector (14)** sobre el **tubo del elemento calentador (5)** y coloque los orificios para los **ornillos de fijación (8)** sobre los mismos.
- 4 Gire el **tubo protector (14)** hasta el tope.
- 5 Apriete los cuatro **ornillos de fijación (8)**.



Cambio del elemento calentador

- El cambio del elemento calentador sólo podrá ser realizado por personal especializado debidamente formado o bajo su supervisión.

- 1  Apague el **interruptor principal (2)** y deje enfriar el aparato. El aparato se desconecta automáticamente.
- 2  Desconecte el **cable de conexión de red (1)** de la red eléctrica.
- 3 Retire los cuatro **ornillos de fijación (8)**. 4 Retire el **tubo del elemento calentador (5)** y el elemento calentador.
- 5 Extraiga el elemento calentador del envoltorio. 6 Monte el elemento calentador y deslice el **tubo del elemento calentador (5)**.
- 7 Monte el **tubo del elemento calentador (5)** con los cuatro **ornillos de fijación (8)**.
- 8  Conecte el **cable de conexión de red (1)** a la red eléctrica. La tensión nominal indicada en el aparato debe coincidir con la tensión de red.

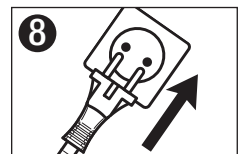
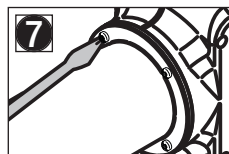
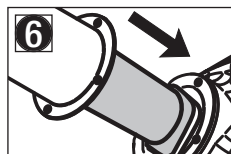
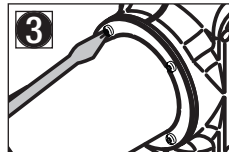
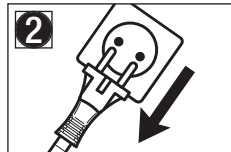
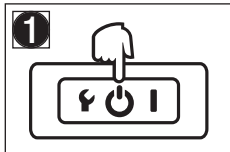

Cambio de reflectores/boquillas



¡Peligro de quemaduras! No toque el tubo del elemento calentador ni la boquilla si están calientes.

Para cambiar la boquilla o el reflector, apague antes el aparato con el **interruptor principal (2)**  y déjelo enfriar. El aparato se desconecta automáticamente.

Montaje

- El aparato sólo debe ser montado por personal especializado debidamente formado.
- Consulte las dimensiones de montaje en la página 3, Dimensiones / Tamaño.



Antes del montaje del aparato, apáguelo con el interruptor principal (2)  y déjelo enfriar. El aparato se desconecta automáticamente.



Desconecte el **cable de conexión de red (1)** de la red eléctrica.

- Asegúrese de que los cables de conexión no toquen el tubo del elemento calentador y no estén expuestos al chorro de aire caliente.
- El aparato debe fijarse a los **insertos roscados (9)** con tres tornillos M5.
- El montaje debe garantizar que
 - sólo se alimente aire frío
 - no se retenga el calor
 - el equipo no reciba el chorro de aire caliente de otro equipo.
- En caso de un alto contenido de polvo en el aire, utilice un filtro de acero inoxidable de Leister (consulte Accesorios) y colóquelo sobre la **brida de entrada de aire (6)**.
- En el caso de partículas especialmente problemáticas (de metal, conductoras de electricidad o húmedas) deberán utilizarse filtros especiales para evitar cortocircuitos en el aparato.
- Proteja el aparato de vibraciones mecánicas y sacudidas.

Funcionamiento

- En caso necesario, monte la boquilla o el reflector que corresponda.



Debe asegurarse de que el aire caliente pueda salir libremente, ya que una retención de aire caliente puede causar daños en el aparato (¡peligro de incendio!).



Conecte el **cable de conexión de red (1)** a la red eléctrica. La tensión nominal indicada en el aparato debe coincidir con la tensión de red.

- Encienda el **interruptor principal (2)** 



Tras el funcionamiento en caliente, apague el aparato con el **interruptor principal (2)**  y déjelo enfriar. El aparato se desconecta automáticamente.



Desconecte el **cable de conexión de red (1)** de la red eléctrica.

- **ATENCIÓN:** Si utiliza el aparato como aparato incorporado, la conexión de red debe disponer de un dispositivo adecuado que asegure la **completa desconexión** de la red con una **distancia de contacto de 3 mm**.

Manejo del HOTWIND PREMIUM

- Ajuste la **temperatura** con el **potenciómetro rojo (3)**.
- Ajuste el **caudal de aire** con el **potenciómetro azul (4)**.

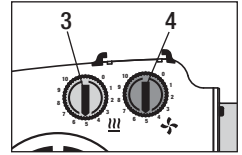

Manejo del HOTWIND SYSTEM

Potenciómetro

- Ajuste la **temperatura** con el **potenciómetro rojo (3)**.
- Ajuste el **caudal de aire** con el **potenciómetro azul (4)**.

Interfaz de sistema

- La temperatura y el caudal de aire pueden controlarse mediante la **interfaz de sistema (12)**. La alarma puede conectarse a través de la **salida de relé de alarma (11)** del aparato.

El **potenciómetro para la temperatura (3)** y el potenciómetro para el **caudal de aire (4)** ya no están operativos.

- Para cambiar entre potenciómetro o interfaz, consulte Configuración en la página 61.

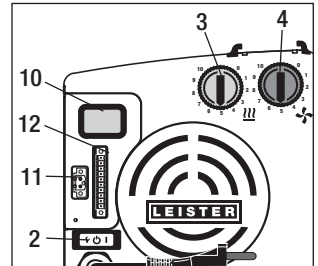

Pantalla (10) HOTWIND SYSTEM

En el menú de configuración pueden realizarse los ajustes necesarios (consulte la página 61).

- **Regulación interna (Closed Loop)**
 - Ajuste la temperatura con el **potenciómetro rojo (3)**.
 - Ajuste el **caudal de aire** con el **potenciómetro azul (4)**.



La pantalla muestra el valor real y nominal de la temperatura

Valor real — 395
Valor nominal — 450 °C

- **Regulación externa (Closed Loop)**
 - Ajuste la **temperatura** mediante el **regulador externo**.
 - Ajuste el **caudal de aire** mediante el **regulador externo**.

- **Control interno (Open Loop)**
 - Ajuste el **valor nominal de potencia** para la temperatura con el **potenciómetro rojo (3)**.
 - Ajuste el **valor nominal para el caudal de aire** con el **potenciómetro azul (4)**.



La pantalla muestra el valor nominal de potencia en % y el valor real de la temperatura

Valor real — 490
Valor nominal % — 75P °C

- **Control externo (Open Loop)**
 - Ajuste el **valor nominal de potencia** para la temperatura mediante el **regulador externo**.
 - Ajuste el **valor nominal para el caudal de aire** mediante el **regulador externo**.

Configuración y manejo del HOTWIND SYSTEM

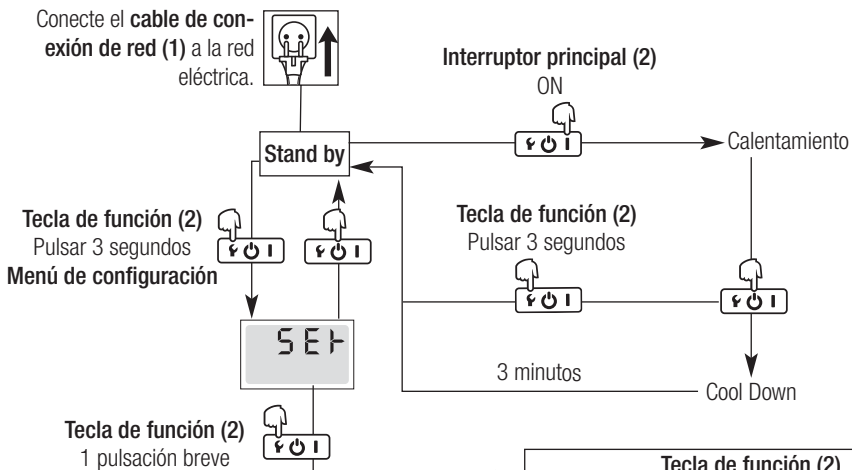

Legenda

Indicación	Descripción
Ri r (Air)	Valor nominal caudal de aire
CEL (°C)	Celsius
CLO (Closed Loop)	Regulado
CON (Connector)	Interfaz
FRr (°F)	Fahrenheit
HER (Heater)	Valor nominal calentamiento
LOO (Loop)	Regulación
OPE (Open Loop)	Dirigido
POT (Pot)	Potenciómetro
SEt (Setup)	Configuración
Un: (Unit)	Unidad

Si en el **menú de configuración** no se pulsa la **tecla de función (2)** en 10 segundos, el aparato pasa automáticamente al **modo de espera**.

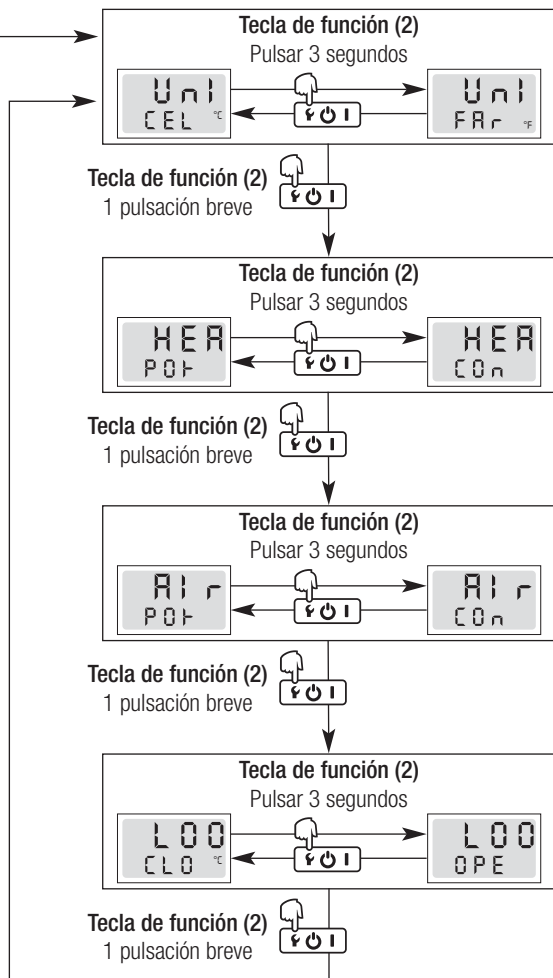

Error

- Si se produce un fallo de funcionamiento en el aparato, aparece un mensaje en la **pantalla (10)** con un código de error adicional. Este código representa una indicación precisa del fallo (consulte la tabla).
- Los errores pueden restablecerse (reset) pulsando la **tecla de función (2)**  durante tres segundos.



Pantalla	Denominación	Causa del fallo	Solución del fallo
Err 01	Temperatura del aparato demasiado alta	Temperatura ambiente por encima de lo especificado	Reducir temperatura ambiente
		Temperatura de aire de alimentación por encima de lo especificado	Reducir temperatura de aire de alimentación
		Entrada de aire bloqueada	Revisar entrada de aire
		Filtro de acero inoxidable bloqueado	Limpiar filtro de acero inoxidable
		Salida de aire bloqueada	Revisar salida de aire
		Se ha montado una boquilla incorrecta	Controlar boquilla
Err 02	Temperatura del elemento calentador demasiado alta	Entrada de aire bloqueada	Revisar entrada de aire
		Filtro de acero inoxidable bloqueado	Limpiar filtro de acero inoxidable
		Salida de aire bloqueada	Revisar salida de aire
		Se ha montado una boquilla incorrecta	Cambiar boquilla
Err 03	Sonda de temperatura	Conexión de sonda de temperatura defectuosa	Controlar conexión de la sonda de temperatura
		Sonda de temperatura defectuosa	Contactar con un punto de servicio de Leister
Err 04 Err 05 Err 06 Err 07 Err 08	Contactar con un punto de servicio de Leister		

Accesorios

- **¡Solo pueden utilizarse accesorios de Leister!**

Kit de mango Nº de artículo: 141.723

Filtro de acero inoxidable Nº de artículo: 107.248

- Más accesorios en www.leister.com

Formación

- Leister Technologies AG y sus sucursales de servicio autorizadas ofrecen de forma gratuita cursos y formación sobre soldadura. Encontrará información en www.leister.com.

Mantenimiento

- En caso de suciedad, la **entrada de aire (6)** se deberá limpiar con un pincel.
- Controlar que el **cable de conexión de red (1)** y el enchufe no presenten daños mecánicos ni eléctricos

Servicio y reparaciones

- Las reparaciones se realizarán únicamente en puntos de servicio técnico autorizados por Leister. Éstos garantizan un servicio de reparación fiable y especializado en un plazo adecuado con piezas de repuesto originales conforme a los planos de conexiones y las listas de piezas de repuesto.

Garantía

- Para este aparato existe una garantía básica de un (1) año a partir de la fecha de compra (justificable con recibo de compra o albarán de entrega). Los daños que se produzcan se subsanarán mediante reparación o sustitución. Los elementos calentadores no se incluyen en esta garantía.
- Quedan excluidos otros derechos, salvo por disposiciones legales.
- Quedan excluidos de la garantía los daños atribuidos al desgaste natural, la sobrecarga o el uso inadecuado del aparato.
- No existe ningún derecho en aparatos reformados o modificados por el comprador.

Muitos parabéns pela compra de um HOTWIND !

Optou por um ventilador de ar quente de primeira classe da casa Leister, que é constituído por materiais de elevada qualidade. Cada HOTWIND é submetido a um controlo de qualidade antes de sair da fábrica na Suíça.



Ler manual de instruções antes da colocação em funcionamento e guardar para consulta posterior.

Ventilador de ar quente HOTWIND PREMIUM, HOTWIND SYSTEM

Utilização

O ventilador de ar quente HOTWIND PREMIUM e HOTWIND SYSTEM estão equipados para um funcionamento permanente. São apropriados para a instalação em máquinas, sistemas e aparelhos ou mesmo como aparelhos manuais e de mesa.

As suas mais importantes aplicações são por exemplo na **secagem e aquecimento, descongelação, aceleração e dissolução, esterilização, alisamento, brilho, activação e solução, separação e fundição, encolhimento, soldadura, remoção e ignição.**



Aviso



Perigo de vida ao abrir o aparelho, visto que os componentes sob tensão e ligações estão livres. Antes de abrir o aparelho retirar a ficha da tomada.



Perigo de incêndio e explosão na utilização incorrecta de aparelhos de ar quente, especialmente perto de materiais inflamáveis e gases explosivos.



Perigo de queimaduras! Não tocar no tubo de aquecimento e bocal em estado quente. Deixar arrefecer o aparelho. Não direccionar o jacto de ar quente para pessoas e animais.



Cuidado



A **tensão nominal** mencionada no aparelho tem de corresponder à tensão de rede. EN 61000-3-11; $Z_{max} = 0.053 \Omega + j 0.033 \Omega$. Se necessário, consultar empresa de fornecimento de energia.



Interruptor FI na utilização do aparelho em obras é necessário para a protecção pessoal.



O aparelho **tem de ser** operado **sob vigilância**. O calor pode passar para os materiais inflamáveis, que se encontram fora do campo visual.

O aparelho só pode ser utilizado por **técnicos especializados** ou sob vigilância. A utilização por crianças é proibida.



Proteger o aparelho **de humidade e água**.

Declaração de Incorporação

(de acordo com a directiva da máquina CE 2006/42/ Anexo II B)

Leister Technologies AG, Galileo-Strasse 10, CH-6056 Kaegiswil / Suíça declara com o presente, que a máquina incompleta

Designação: **Hot air blower**
Tipo: **HOTWIND**
Versão: **PREMIUM ou SYSTEM**

– quando possível a partir do volume de fornecimento – corresponde aos requisitos básicos aplicáveis da directiva de máquinas CE (2006/42).

A máquina incompleta corresponde, para além disso, aos requisitos das seguinte(s) directiva(s) CE:

Directiva(s) CE: Compatibilidade electromagnética 2004/108
Directiva de baixa tensão 2006/95

Normas harmonizadas: EN 12100-1, EN 12100-2, EN 60204-1, EN 14121-1,
EN 55014-1, EN 55014-2, EN 61000-6-2,
EN 61000-3-2, EN 61000-3-3, EN 61000-3-11 (Z_{max})
EN 50366, EN 62233, EN 60335-2-45

Para além disso declaramos, que, para esta máquina incompleta, foram elaborados os documentos técnicos especiais conforme o anexo VII (parte B) e responsabilizamo-nos pelo seu envio por via electrónica, a pedido comprovado, pelas autoridades de monitorização do mercado.

Nome do responsável pela documentação: Patrick Rieder, Compliance Manager

A colocação em funcionamento da máquina incompleta é proibida, até que seja determinado, que a máquina, na qual a máquina incompleta foi incorporada, corresponde às determinações da directiva de máquinas CE (2006/42).

Kaegiswil, 28.11.2011

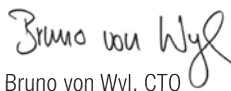
Bruno von Wyl, CTO

Beat Mettler, COO

Eliminação



Ferramenta eléctrica, acessórios e embalagens devem ser entregues para reciclagem amiga do ambiente. Apenas para países UE: Não elimine as ferramentas eléctricas no lixo doméstico! De acordo com a directiva europeia 2002/96 acerca de aparelhos antigos eléctricos e electrónicos e a sua implementação no direito nacional, as ferramentas eléctricas inutilizáveis têm de ser separadas, recolhidas e entregues num ponto de recolha ecológico.

Dados técnicos

Tensão	V~	120	230	230	230	400
Potência	W	2300	2300	3100	3680	5400
Frequência	Hz	50/60				
Temperatura máxima de saída do ar	°C	650	650	800	650	650
Quantidade de ar (20 °C)	l/min.	200 – 900				
Pressão estática máx.	Pa	820	1050			
Nível de emissão	L _{PA} (dB)	< 70				
Peso sem cabo de alimentação	kg	2.2	2.2	2.3	2.2	2.4
Massa	Página 3 (Size)					
Símbolo de conformidade	CE					
Símbolo de segurança						
Tipo de certificação						
Classe de protecção II	□					
Reservam-se os direitos a alterações técnicas.						
Não é possível comutar a tensão de ligação						

	PREMIUM	SYSTEM
Capacidade de aquecimento e quantidade de ar com potenciómetro ajustável sem níveis	•	•
Sistema electrónico de potência integrado	•	•
Protecção contra sobreaquecimento do elemento de aquecimento e dos aparelhos	•	•
Saída do alarme		•
Regulador de temperatura integrado		•
Interface de comando à distância para a indicação da temperatura ou potência		•
Interface de comando à distância para indicação das quantidades de ar		•
Sonda térmica integrada		•
Visor para a indicação dos valores nominais e reais (°C ou °F)		•

Dados técnicos interface

PREMIUM, SYSTEM Saída do relé	Tensões máximas	AC 250 V, DC 30 V
	Correntes máximas	AC 3 A, DC 3 A
	Resistência de contacto máxima	100 m Ohm a DC 6 V / 1 A
	Tipo de contacto	SPST - NO
	Isolamento IEC/EN 60065	AC 2000 V (50 - 60 Hz) 1 min
SYSTEM Entrada de sinais com protecção de polarização e correcção do ponto zero	Isolamento IEC/EN 60747-5-2	AC 1414 V Peak
	Entrada de tensão relativo a Uc para GND iso	DC 0 - 10 V (ondulação < 0.05 V a 5 °C resolução) (ondulação < 0.1 V a 1 % resolução)
	Tensão de entrada máxima	DC 12 V
	Resistência nominal e de entrada	280 kOhm
	Entrada de corrente Ic (tecnologia 2 condutores)	DC 4...20 mA (ondulação < 0.1 mA a 5 °C resolução) (ondulação < 0.15 mA a 1 % resolução)
	Corrente de entrada máxima	DC 22 mA
	Resistência nominal e de entrada	160 Ohm
Alimentação com protecção de polarização sem separação das entradas do sinal	Tensão de funcionamento Us relativa a GND iso	DC 15...24 V
	Tensão de funcionamento máxima	DC 25 V
	Absorção de corrente	12 mA a DC 24 V
Open Loop ou Closed Loop	Função de ajuste potência	Grau de ajuste OFF...100 %; Passos 1%
	Função do regulador temperatura	Indicação do valor nominal 50 °C...650 °C, Passos 5 °C
Indicação do valor nominal Potenciómetro ou interface	Potenciómetro interno	Valor nominal OFF...100 % ou 50 °C ...650 °C
	Interface externa	Valor nominal OFF...100 % ou 50 °C ...650 °C

Descrição do aparelho

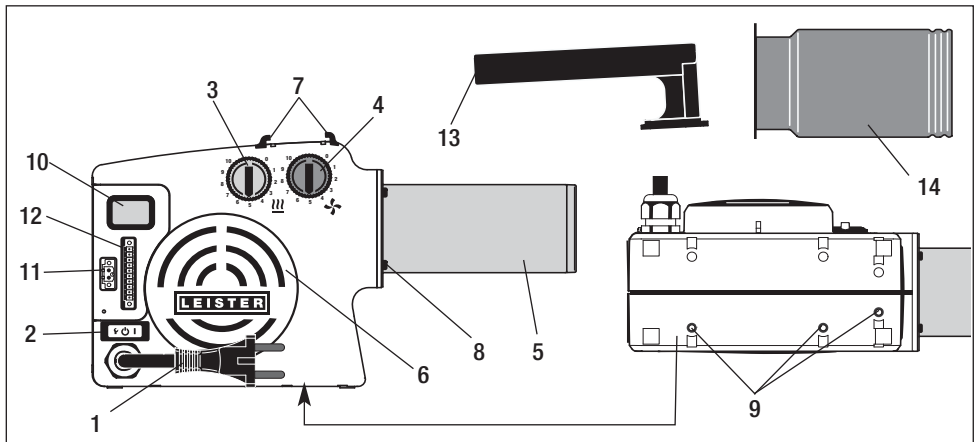

HOTWIND PREMIUM ou SYSTEM

- 1 Cabo de alimentação
- 2 Interruptor principal com botão de função
- 3 Potenciômetro para temperatura (vermelho)
- 4 Potenciômetro para quantidade de ar (azul)
- 5 Tubo de aquecimento
- 6 Flange de entrada de ar para filtro em aço inoxidável
- 7 Suporte para pega
- 8 Quatro parafusos de fixação
- 9 Três aplicações de rosca M5 para fixação para a montagem

HOTWIND SYSTEM

- 10 Visor
- 11 Contacto do alarme
- 12 Interface

Aparelho manual HOTWIND PREMIUM ou SYSTEM

- 13 Pega
- 14 Tubo de protecção

Função protecção do elemento de aquecimento e dos aparelhos

- Se o elemento de aquecimento ou o aparelho sobreaquecerem (ar de admissão muito quente ou acumulação de calor), a alimentação de potência para o elemento de aquecimento é interrompida e aberto o contacto de serviço do relé do alarme. Se a protecção do elemento de aquecimento ou a protecção do aparelho não responderem, é necessário, por motivos de segurança, a reposição (Reset) do HOTWIND'. Isto acontece ao premir o **botão de função (2)**  por três segundos. Verificar ar de admissão (ver montagem).

Valores de ajuste potenciômetro

- O sistema electrónico interno limita a temperatura de saída do ar máxima para 650 °C.
- São valores de referência que podem sofrer um desvio devido às condições ambientais e tolerâncias dos componentes.

Potenciômetro Posição	0	1	2	3	4	5	6	7	8	9	10
Capacidade de aquecimento %	OFF	10	20	30	40	50	60	70	80	90	100
Quantidade de ar l/min	200	270	340	410	480	550	620	690	760	830	900
Temperatura (3680 W) a 300 l/min °C	Ambiente	90	150	215	275	340	400	465	525	590	650

Diagrama da temperatura /quantidades de ar

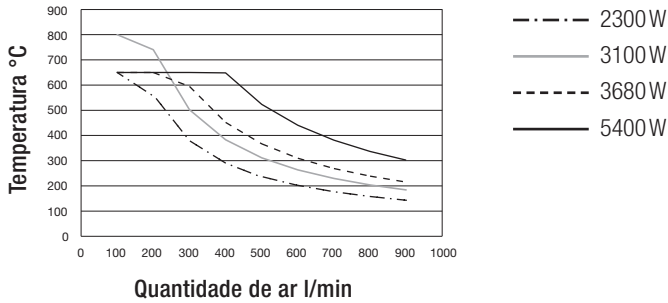

HOTWIND SYSTEM

Interface

11 Contacto do alarme

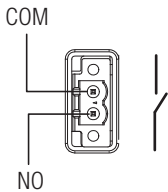

12 Interface

Quantidade de ar

15 - 24 VDC
4 - 20 mA -
4 - 20 mA +
0 - 10 V
GND

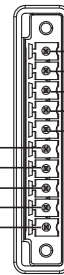

Capacidade de aquecimento

15 - 24 VDC
4 - 20 mA -
4 - 20 mA +
0 - 10 V
GND

Na ligação de rede tem de existir um dispositivo apropriado para a separação de todos os pólos da rede com uma **distância entre os contactos de 3 mm.**

Contacto do alarme: SPST-NO 250 VAC / 30 VDC, 3A $\cos \phi = 1$

Activação HOTWIND SYSTEM

Input 0 - 10 V

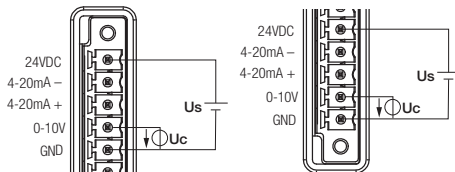

Capacidade de aquecimento Quantidade de ar

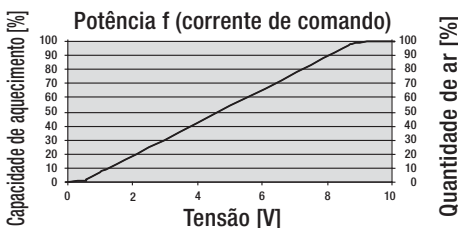

Input 4 - 20 mA

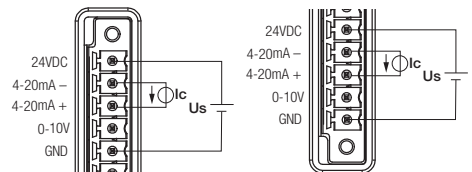

Capacidade de aquecimento Quantidade de ar

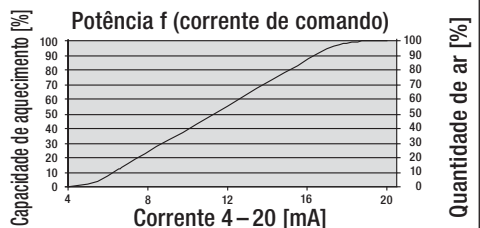

Atenção: Com uma quantidade de ar de 0% aproximadamente 200 l/min

Handle Kit

- A montagem do Handle Kit apenas pode ser efectuada por técnicos especializados ou sob a sua vigilância.
- A pega (13) e o tubo de protecção (14) não estão incluídos no volume de fornecimento (ver acessórios).



Antes da montagem do Handle Kit desligar o aparelho com o **interruptor principal (2)** e deixar arrefecer. Aparelho desliga-se automaticamente.



e



Separar **cabo de alimentação (1)** da rede eléctrica.

Montagem do Handle Kit

- 1 Deslocar a **pega (13)** para o **suporte (7)**.
- 2 Soltar os quatro **parafusos de fixação (8)** (não remover).
- 3 Deslocar o **tubo de protecção (14)** para o **tubo do elemento de aquecimento (5)** e inserir na abertura dos **parafusos de fixação (8)**.
- 4 Rodar o **tubo de protecção (14)** até ao encosto.
- 5 Apertar os quatro **parafusos de fixação (8)**.



Substituição do elemento de aquecimento

- A substituição do elemento de aquecimento só pode ser efectuada por técnicos especializados ou sob vigilância.



1 Desligar o **interruptor principal (2)** e deixar arrefecer o aparelho. Aparelho desliga-se automaticamente.



2 Separar **cabo de alimentação (1)** da rede eléctrica.

3 Remover os **quatro parafusos de fixação (8)**. 4 Remover o **tubo do elemento de aquecimento (5)** e elemento de aquecimento.

5 Retirar o elemento de aquecimento da embalagem. 6 Montar elemento de aquecimento e passar o **tubo do elemento de aquecimento (5)** por cima.

7 Montar **tubo do elemento de aquecimento (5)** com **quatro parafusos de fixação (8)**.

8  Ligar o **cabo de alimentação (1)** à rede eléctrica. A tensão nominal mencionada no aparelho tem de corresponder à tensão de rede.

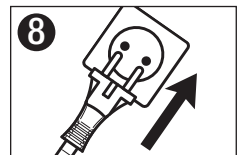
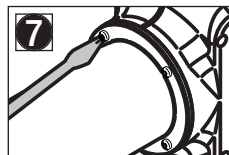
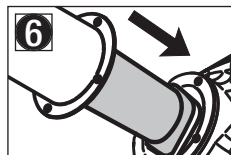
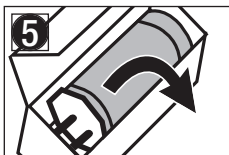
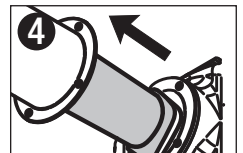
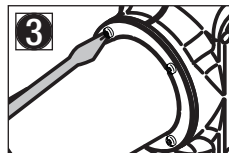
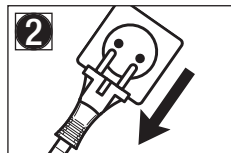
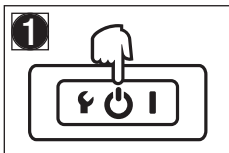

Substituição do bocal / reflector



Perigo de queimaduras! Não tocar no tubo de aquecimento e bocal em estado quente.

Ao substituir o bocal ou reflector desligar o aparelho com o **interruptor principal (2)** e deixar arrefecer. Aparelho desliga-se automaticamente.



Montagem

- O aparelho só pode ser montado por técnicos especializados.
- Massa de montagem ver página 3, massa / Size.



Antes da montagem desligar o aparelho com o **interruptor principal (2)** e deixar arrefecer. Aparelho desliga-se automaticamente.



Separar **cabo de alimentação (1)** da rede eléctrica.

- Tem de ser certificado, que as linhas de ligação não toquem no tubo do elemento de aquecimento e não sejam expostas ao jacto do ar quente.
- O aparelho tem de ser fixado com três parafusos M5 nas **aplicações de roscas (9)**.
- A instalação tem de garantir, que
 - apenas é introduzido ar frio
 - não se cria uma acumulação de (calor)
 - que o aparelho não seja atingido por um jacto de ar quente de outro aparelho.
- Em caso de ar com partículas de pó utilizar o filtro em aço inoxidável da Leister (ver acessórios) e deslocar para cima do **flange de admissão de ar (6)**.
- Em caso de poeiras críticas (p.ex. poeiras metálicas, condutoras de electricidade ou húmidas) têm de ser usados filtros especiais para evitar curto-circuitos no aparelho.
- Proteger o aparelho de vibrações e oscilações mecânicas.

Operação

- Se necessário, montar respectivo bocal ou reflector.



Deve-se observar, que o ar quente deve sair sem problemas, caso contrário, o aparelho pode sofrer danos devido à acumulação de calor (perigo de incêndio!).



Ligar o **cabo de alimentação (1)** à rede eléctrica A tensão nominal mencionada no aparelho tem de corresponder à tensão de rede.

- Ligar **Interruptor principal (2)**



Após o funcionamento a quente desligar o aparelho com o **interruptor principal (2)** e deixar arrefecer. Aparelho desliga-se automaticamente.



Separar **cabo de alimentação (1)** da rede eléctrica.

- **ATENÇÃO:** Na utilização como aparelho de montagem tem de existir uma ligação à rede com dispositivo apropriado **para a separação dos pólos** da rede com uma **distância entre os contactos de 3 mm**.

Operação HOTWIND PREMIUM

- Ajustar **temperatura** com **potenciômetro (3)** vermelho.
- Ajustar **quantidade de ar** com **potenciômetro (4)** azul.

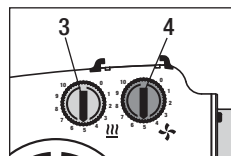

Operação HOTWIND SYSTEM

Potenciômetro

- Ajustar **temperatura** com **potenciômetro (3)** vermelho.
- Ajustar **quantidade de ar** com **potenciômetro (4)** azul.

Interface do sistema

- A temperatura e quantidade de ar podem ser controladas através da **interface do sistema (12)**. O alarme pode ser ligado através da **saída do relé do alarme (11)** do aparelho.

O **potenciômetro para a temperatura (3)** e o potenciômetro para a **quantidade de ar (4)** não possuem mais nenhuma função.

- Para a comutação entre o potenciômetro ou interface ver configuração página 73.

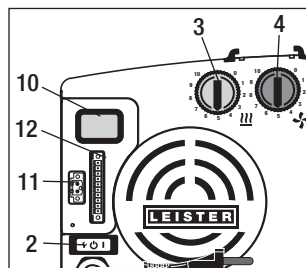

Visor (10) HOTWIND SYSTEM

No menu Setup efectuar respectivas configurações (ver página 73).

- **Regulação interna (Closed Loop)**
 - Ajustar **temperatura** com **potenciômetro (3)** vermelho.
 - Ajustar **quantidade de ar** com **potenciômetro (4)** azul.
- **Regulação externa (Closed Loop)**
 - Ajustar **temperatura** com **regulador externo**.
 - Ajustar **quantidade de ar** com **regulador externo**.



O visor mostra o valor real e nominal da temperatura no

Valor real — 395
Valor nominal — 450 °C

- **Comando interno (Open Loop)**
 - Ajustar **valor nominal de potência** com **potenciômetro (3)** vermelho para temperatura.
 - Ajustar **valor nominal das quantidades de ar** com **potenciômetro (4)** azul para quantidades de ar.
- **Comando externo (Open Loop)**
 - Ajustar **valor nominal de potência** com **regulador externo** para temperatura.
 - Ajustar **valor nominal das quantidades de ar** com **regulador externo** para quantidades de ar.



O visor mostra o Valor nominal de potência em % e o valor real da temperatura

Valor real — 490
Valor nominal % — 75P °C

Configuração e operação HOTWIND SYSTEM

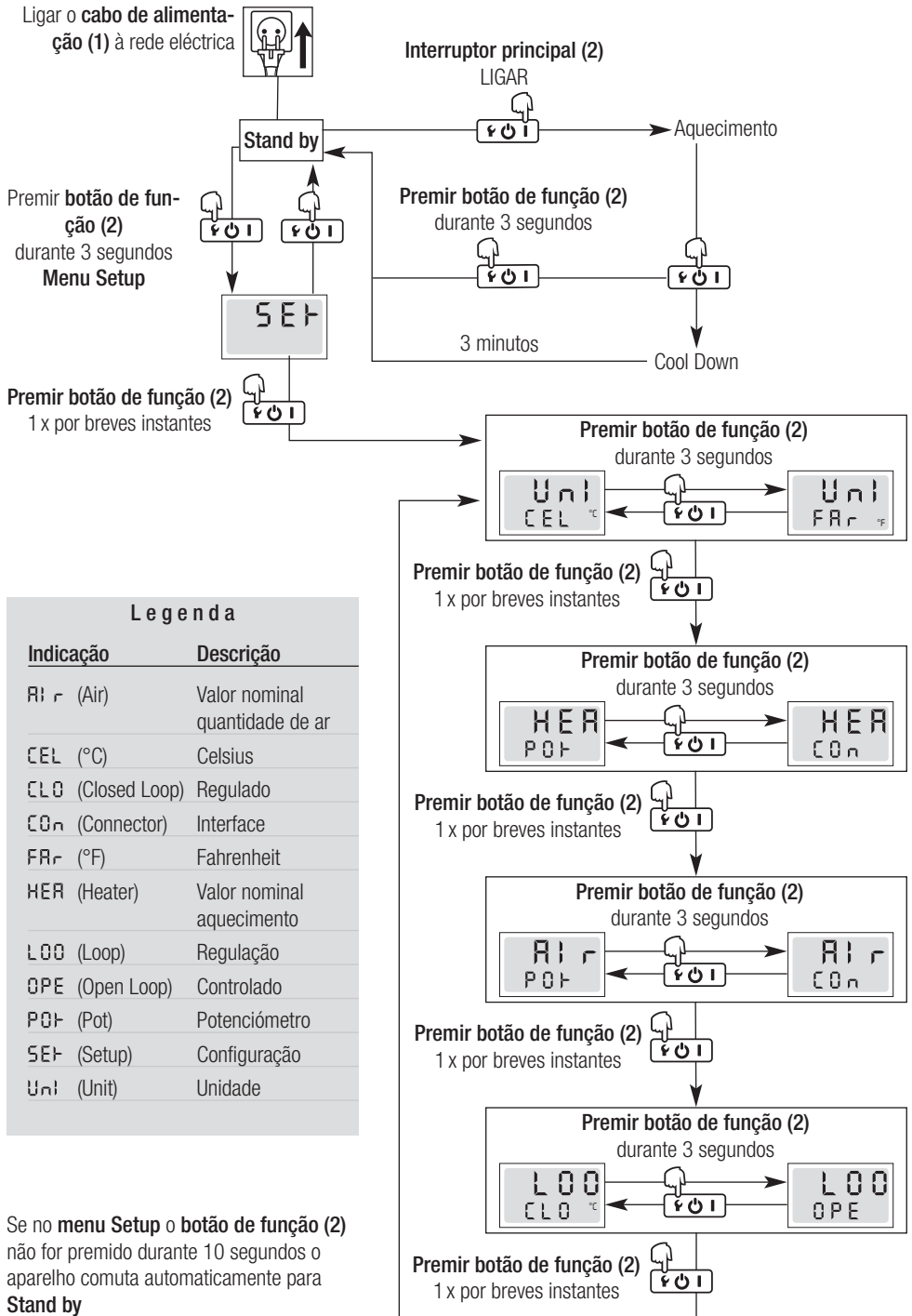

Error

- Se surgir uma falha no aparelho, aparece no **visor (10)** uma mensagem, à qual é atribuído adicionalmente um código de erro. Este código refere-se a uma descrição mais detalhada da falha (ver tabela).
- Um Error pode ser reposto (reset) premindo o **botão de função (2)**  durante três segundos.

Visor	Designação	Causa do erro	Eliminação de falhas
Err 01	Temperatura do aparelho demasiado elevada	Temperatura ambiente superior ao especificado	Reduzir temperatura ambiente
		Temperatura do ar de admissão superior ao especificado	Reduzir temperatura de admissão
		Admissão de ar bloqueada	Verificar entrada de ar
		Filtro de aço inoxidável bloqueado	Limpar filtro de aço inoxidável
		Saída de ar bloqueada	Verificar saída de ar
		Bocal errado montado	Controlar bocal
Err 02	Temperatura do elemento de aquecimento demasiado elevada	Admissão de ar bloqueada	Verificar entrada de ar
		Filtro de aço inoxidável bloqueado	Limpar filtro de aço inoxidável
		Saída de ar bloqueada	Verificar saída de ar
		Bocal errado montado	Substituir bocal
Err 03	Sonda de temperatura	Ligação sonda térmica com falha	Controlar ligação da sonda térmica
		Sonda térmica com falha	Contactar posto de assistência da Leister
Err 04 Err 05 Err 06 Err 07 Err 08	Contactar posto de assistência da Leister		

Acessórios

- **Apenas podem ser utilizados acessórios da Leister!**

Handle Kit Nº do artigo 141.723

Aço inoxidável filtro Nº do artigo 107.248

- Mais acessórios em www.leister.com

Formação

- Leister Technologies AG e os seus pontos de assistência autorizados oferecem cursos de soldadura e formações gratuitamente. Informações em www.leister.com.

Manutenção

- A **entrada do ar (6)** deve ser limpa com um pincel em caso de sujidade
- Verificar **cabo de alimentação (1)** e ficha quanto a danos eléctricos e mecânicos.

Assistência e reparação

- As reparações devem ser efectuadas por **pontos de assistência Leister** autorizados. Estes garantem dentro do prazo útil um **serviço de reparação** especializado e fiável com peças de substituição originais de acordo com os esquemas eléctricos e listas de peças de substituição.

Garantia

- Para este aparelho existe uma garantia básica de um (1) ano a partir da data da compra (comprovativo através da factura ou guia transporte). Danos que surgem são eliminados através de fornecimento de reposição ou reparação. Os elementos de aquecimento estão excluídos desta garantia.
- Prescrições legais reservadas excluem outros direitos.
- Danos causados por desgaste natural, sobrecarga ou tratamento incorrecto, são excluídos da garantia.
- Aparelhos que foram alterados pelo comprador não têm direito à garantia.



Bruksanvisning (Översättning av original driftanvisning)

Vi gratulerar dig till att du köpt en HOTWIND!

Du har valt en förstklassig varmluftsfläkt från Leister och den består av material av hög kvalitet. Varje HOTWIND genomgår en sträng kvalitetskontroll innan den lämnar fabriken i Schweiz.



Läs igenom denna bruksanvisning noggrant och förvara den för framtida användning.

Varmluftsfläkt HOTWIND PREMIUM, HOTWIND SYSTEM

Användning

Varmluftsfläktarna HOTWIND PREMIUM och HOTWIND SYSTEM är konstruerade för kontinuerlig drift. De passar utmärkt till montering i maskiner, anläggningar och apparater men även som hand- eller bordsapparater.

Deras viktigaste användningar är t.ex. att torka och värma, tina, påskynda och upplösa, sterilisera, utjämna, polera, aktivera och lossa, separera och smälta ihop, krympa, löda, svetsa, ta bort, antända.



Varning



Livsfara om apparater öppnas eftersom spänningsförande komponenter och anslutningar friläggs. Dra alltid ut stickproppen från vägguttaget innan apparaten öppnas.



Brand- och explosionsrisk vid osakkunnig användning av varmluftsapparater, i synnerhet i närheten av antändliga material och explosiva gaser.



Risk för brännskador! Rör inte värmeelementrör och munstycke när de är mycket varma. Låt apparaten svalna. Rikta aldrig värmestrålen mot personer eller djur.



Obs!



Märkspänning, som är angiven på apparaten måste överensstämma med nätspänningen. EN 61000-3-11; $Z_{max} = 0.053 \Omega + j 0.033 \Omega$. Rådfråga ditt lokala elbolaget vid behov.



En **FI-brytare** krävs uttryckligen för personskyddet när apparaten används på byggplatser.



Apparaten får endast användas **under tillsyn**. Värme kan ta sig till brännbara material som befinner sig utom synhåll.

Apparaten får endast användas av **utbildad fackpersonal** eller under deras tillsyn. Det är förbjudet för barn att använda apparaten.



Skydda apparaten **mot fukt och väta**.

Försäkran om inbyggnad

(Enligt EG-maskindirektivet 2006/42; bilaga II B)

Leister Technologies AG, Galileo-Strasse 10, CH-6056 Kaegiswil/Schweiz förklarar härmed att den delvis fullbordade maskinen

Beteckning: **Hot air blower**
Modell: **HOTWIND**
Utförande: **PREMIUM eller SYSTEM**

– så långt leveransinnehållet tillåter – uppfyller de tillämpliga, principiella kraven i EG-maskindirektivet (2006/42).

Den delvis fullbordande maskinen uppfyller dessutom kraven i de följande EG-direktiven:

EG-direktiv: Elektromagnetisk kompatibilitet 2004/108
Lågspänningsdirektivet 2006/95

Harmoniserade standarder: EN 12100-1, EN 12100-2, EN 60204-1, EN 14121-1,
EN 55014-1, EN 55014-2, EN 61000-6-2,
EN 61000-3-2, EN 61000-3-3, EN 61000-3-11 (Z_{max})
EN 50366, EN 62233, EN 60335-2-45

Vi förklarar dessutom att den speciella tekniska dokumentationen enligt bilaga VII (del B) för den delvis fullbordade maskinen har sammanställts och vi åtar oss att sända den elektroniskt till myndigheterna för marknadsövervakning efter motiverad förfrågan.

Namn på befullmäktigad för dokumentationen: Patrick Rieder, Compliance Manager

Idrifttagningen av den delvis fullbordade maskinen är förbjuden tills det, när aktuellt, fastställts att maskinen som den delvis fullbordade maskinen satts in i uppfyller bestämmelserna i EG-maskindirektivet (2006/42).

Kaegiswil, 28.11.2011

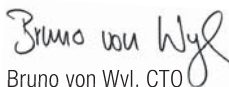
Bruno von Wyl, CTO

Beat Mettler, COO

Avfallshantering



Elektriska verktyg, tillbehör och förpackningar ska lämnas till en miljövänlig återvinning. Endast för EU-länder: Kasta inte elverktyg i soporna! Enligt det europeiska direktivet 2002/96 beträffande uttjänta elektriska och elektroniska apparater och dess implementering i nationell lagstiftning måste elektriska verktyg som inte kan användas mer samlas separat och lämnas till en miljövänlig återvinning.

Tekniska data

Spänning	V~	120	230	230	230	400
Effekt	W	2300	2300	3100	3680	5400
Frekvens	Hz	50/60				
Max. luftutströmningstemperatur	°C	650	650	800	650	650
Luftmängd (20 °C)	l/min.	200 – 900				
Statiskt tryck max.	Pa	820	1050			
Bullernivå	L_{pA} (dB)	< 70				
Vikt utan nätsladd	kg	2.2	2.2	2.3	2.2	2.4
Mått		Sidan 3 (Size)				
Överensstämmelsesymbol		CE				
Säkerhetssymboler						
Certifieringstyp						
Kapslingsklass II		□				
Tekniska ändringar förbehållna						
Anslutningsspänningen ej omkopplingsbar						

	PREMIUM	SYSTEM
Värmeeffekt och luftmängd kan ställas in steglöst med potentiometer	•	•
Integrerad kraftelektronik	•	•
Skydd mot värmeelement- och apparatöverhettning	•	•
Larmutgång		•
Integrerat temperaturreglage		•
Fjärrstyrnings-gränssnitt för planerad temperatur eller effekt		•
Fjärrstyrnings-gränssnitt för planerad luftmängd		•
Integrerad temperatursond		•
Display för visning av bör- och är-värden (°C eller °F)		•

Tekniska data gränssnitt

PREMIUM, SYSTEM Reläutgång	Max. spänningar	AC 250 V, DC 30 V
	Max. strömmar	AC 3 A, DC 3 A
	Max. kontaktmotstånd	100 m Ohm vid DC 6 V / 1 A
	Kontakttyp	SPST - NO
	Isolering IEC/EN 60065	AC 2000 V (50 - 60Hz) 1 min

SYSTEM Signalingångar med felpolningsskydd och nollpunktskorrigerig	Isolering IEC/EN 60747-5-2	AC 1414 V Peak
	Spänningsingång U _c baserad på GND iso	DC 0 - 10 V (Rippel < 0,05 V vid 5 °C upplösning) (Rippel < 0,1 V vid 1 % upplösning)
	Max. ingångsspänning	DC 12 V
	Märk-ingångsmotstånd	280 kOhm
	Strömingång I _c (2-ledarteknik)	DC 4...20 mA (Rippel < 0,1 mA vid 5 °C upplösning) (Rippel < 0,15 mA vid 1 % upplösning)
	Max. ingångsström	DC 22 mA
	Märk-ingångsmotstånd	160 Ohm
Matning med felpolningsskydd utan separering från signalingångarna	Driftspänningen U _s baserad på GND iso	DC 15...24 V
	Max. driftsspänning	DC 25 V
	Strömförbrukning	12 mA vid DC 24 V

Open Loop eller Closed Loop	Ställfunktion effekt	Output OFF...100 %; 1% steg
	Reglerfunktion temperatur	Planerat börvärde 50 °C...650 °C, 5 °C steg
Planerat börvärde Potentiometer eller gränssnitt	Intern potentiometer	Börvärde OFF...100 % eller 50 °C ...650 °C
	Externt gränssnitt	Börvärde OFF...100 % eller 50 °C ...650 °C

Apparatbeskrivning

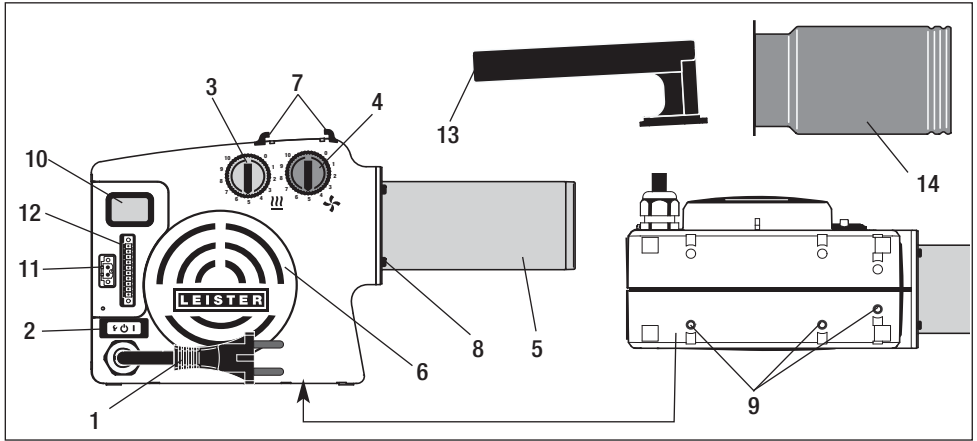

HOTWIND PREMIUM eller SYSTEM

- 1 Nätssladd
- 2 Huvudströmbrytare med funktionsknapp
- 3 Potentiometer för temperatur (röd)
- 4 Potentiometer för luftmängd (blå)
- 5 Värmeelementrör
- 6 Luftinloppsfläns för specialstålsfilter
- 7 Hållare för handtag
- 8 Fyra fästskruvar
- 9 Tre gänginsatser M5 för fastsättningen för monteringen

HOTWIND SYSTEM

- 10 Display
- 11 Larmkontakt
- 12 Gränssnitt

Handenhet HOTWIND PREMIUM eller SYSTEM

- 13 Handtag
- 14 Skyddsörm

Funktion värmeelement- och apparatskydd

- Om värmeelementet eller apparaten blir för varma (för varm insugsluft eller värmeansamling) så avbryts effektmatningen till värmeelementet och larmreläets arbetskontakt öppnas. Om värmeelementskydd eller apparatskydd löser ut är det nödvändigt att återställa (Reset) HOTWIND. Detta görs genom intryckning av **funktionsknappen (2)** under tre sekunder. Kontrollera insugsluft (se Montering).



Inställningsvärden potentiometer

- Den interna elektroniken begränsar den maximala luftutströmnings- temperaturen till 650 °C.
- Det är riktvärden som kan avvika på grund av omgivningsvillkoren och komponenttoleranserna.

Potentiometer Position	0	1	2	3	4	5	6	7	8	9	10
Värmeeffekt %	OFF	10	20	30	40	50	60	70	80	90	100
Luftmängd l/min	200	270	340	410	480	550	620	690	760	830	900
Temperatur (3680W) vid 300 l/min °C	Omgivning	90	150	215	275	340	400	465	525	590	650

Temperatur- /luftmängddiagram

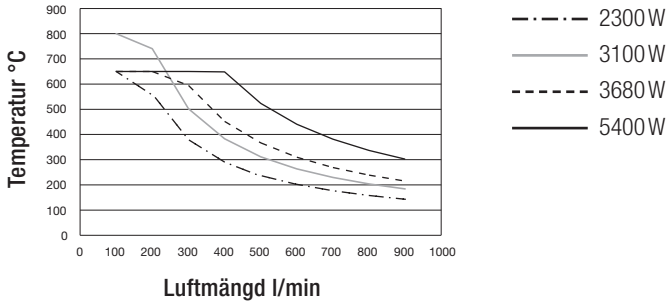

HOTWIND SYSTEM

gränssnitt

11 Larmkontakt

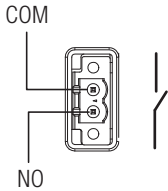

12 Gränssnitt

Luftmängd

15 - 24 VDC
4 - 20 mA -
4 - 20 mA +
0 - 10 V
GND

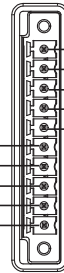

Värmeeffekt

15 - 24 VDC
4 - 20 mA -
4 - 20 mA +
0 - 10 V
GND

I elanslutningen måste det finnas en lämplig anordning för allpolig separering från elnätet med ett **kontaktavstånd på 3 mm**.

Larmkontakt: SPST-NO 250 VAC / 30 VDC, 3 A $\cos \varphi = 1$

HOTWIND SYSTEM adressering

Input 0 - 10 V

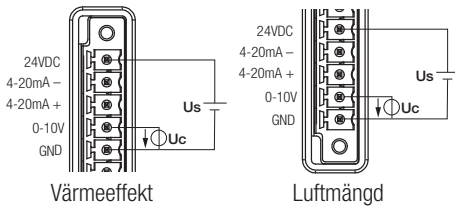

Effekt f (styrspänning)

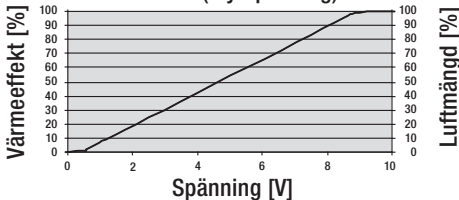

Input 4 - 20 mA

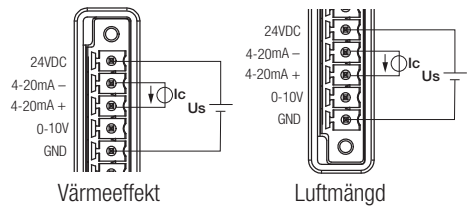

Effekt f (styrström)

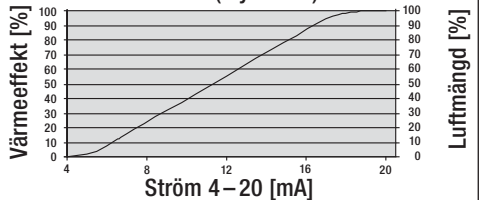

Obs: Vid 0 % luftmängd ca. 200 l/min

Handle Kit

- Handle Kit får bara monteras av utbildad fackpersonal eller under deras tillsyn.
- **Handtag (13)** och **skyddsrör (14)** ingår inte i leveransen (se tillbehör).



Stäng av apparaten med hjälp av **strömbrytaren (2)** och låt den kylas av innan Handle Kit monteras. Apparaten stängs av automatiskt.



och låt den kylas av innan Handle Kit monteras.



Skilj **nätsladden (1)** från elnätet.

Montage Handle Kit

- 1 Skjut på **handtag (13)** på **hållaren (7)**.
- 2 Lossa de fyra **fästskruvarna (8)** (ta inte bort dem).
- 3 Skjut på **skyddsrör (14)** på **värmeelementrör (5)** och tryck in i öppningen för **fästskruvar (8)**.
- 4 Vrid **skyddsrör (14)** till anslag.
- 5 Dra fast de fyra **fästskruvarna (8)**.



Byta värmeelement

- Värmeelement får bara bytas av utbildad fackpersonal eller under deras tillsyn.



Stäng av **huvudströmbrytaren (2)** och låt apparaten kylas av. Apparaten stängs av automatiskt.



Skilj **nätsladden (1)** från elnätet.

- 3 Ta bort de **fyra fästskruvarna (8)**. 4 Ta bort **värmeelementrör (5)** och värmeelement.
- 5 Plocka ut värmeelement ur förpackningen. 6 Montera värmeelement och skjut på **värmeelementrör (5)**.
- 7 Montera **värmeelementrör (5)** med **fyra fästskruvar (8)**.
- 8 Anslut **nätsladden (1)** till elnätet. Märkspänningen som är angiven på apparaten måste överensstämma med nätspänningen.

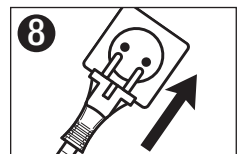
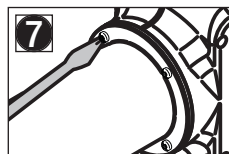
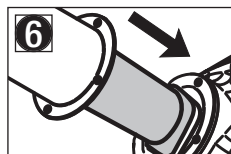
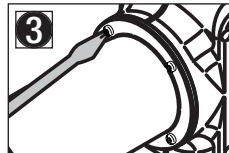
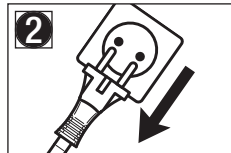
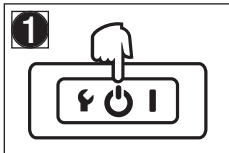

Byta munstycken-/reflektor



Risk för brännskador! Rör inte värmelementrör och munstycke när de är mycket varma.

Stäng först av apparaten med hjälp av **huvudströmbrytaren (2)**



och låta den kylas av när munstycket eller reflektorn ska bytas.

Apparaten stängs av automatiskt.

Montering

- Apparaten får endast monteras av utbildad fackpersonal.
- Monteringsmått se sidan 3, mått/Size.



Stäng av apparaten med hjälp av **huvudströmbrytaren (2)**



och låt den kylas av före monteringen.

Apparaten stängs av automatiskt.



Skilj **nätsladden (1)** från elnätet.

- Det måste vara säkerställt att anslutningsledningarna inte rör vid värmelementröret och att de inte utsätts för varmluftsstrålen.
- Apparaten måste fästas på **gänginsatserna (9)** med tre M5-skruvar.
- Monteringen måste garantera att
 - endast kall luft tillförs
 - ingen (värme-) ansamling skapas
 - apparaten inte utsätts för en annan apparats varmluftsstråle.
- När luften innehåller damm ska Leisters rostfritt-stålfiler (se tillbehör) användas och skjutas på **luftinloppsflänsen (6)**.
- När det gäller extra kritiskt damm (t.ex. metall-, elektriskt ledande eller fuktigt damm) måste speciella filter användas för att undvika kortslutningar i apparaten.
- Skydda apparaten mot mekaniska vibrationer och stötar.

Drift

- Montera det munstycke eller den reflektor som behövs.



Det är viktigt att varmluften kan strömma ut fritt eftersom apparaten annars kan skadas genom värmeansamling (brandrisk!).



Anslut **nätsladden (1)** till elnätet. Märkspänningen som är angiven på apparaten måste överensstämma med nätspänningen.

- Slå på  **huvudströmbrytare (2).**



Stäng av apparaten med hjälp av **huvudströmbrytaren (2)**



efter uppvärmningen och låt den kylas av. Apparaten stängs av automatiskt.



Skilj **nätsladden (1)** från elnätet.

- **OBS!** Vid användning som inbyggnadskomponent måste det finnas en lämplig anordning i elanslutningen för **allpolig separering** från elnätet med ett kontaktavstånd på 3 mm.

Manövrering HOTWIND PREMIUM

- Ställ in **temperatur** med röd **potentiometer (3)**.
- Ställ in **luftmängd** med blå **potentiometer (4)**.

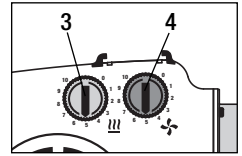

Manövrering HOTWIND SYSTEM

Potentiometer

- Ställ in **temperatur** med röd **potentiometer (3)**.
- Ställ in **luftmängd** med blå **potentiometer (4)**.

Systemgränssnitt

- Temperaturen och luftmängden kan regleras över **systemgränssnittet (12)**. Larmet kan anslutas över apparatens **larm- reläutgång (11)**. **Potentiometern för temperatur (3)** och **potentiometern för luftmängd (4)** har ingen funktion mer.
- För omkoppling mellan potentiometer eller gränssnitt, se Konfiguration på sidan 85.

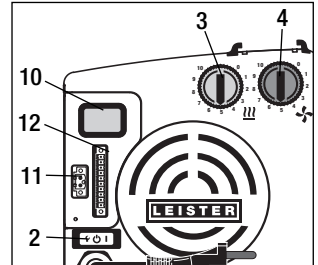

Display (10) HOTWIND SYSTEM

Utför motsvarande inställningar i menyn Setup (se sidan 85).

- **Intern reglering (Closed Loop)**
 - Ställ in **temperatur** med röd **potentiometer (3)**.
 - Ställ in **luftmängd** med blå **potentiometer (4)**.
- **Extern reglering (Closed Loop)**
 - Ställ in **temperatur** med hjälp av **extern regulator**.
 - Ställ in **luftmängd** med hjälp av **extern regulator**.

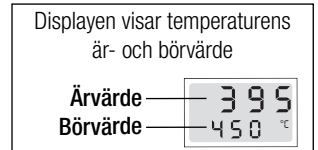

- **Intern styrning (Open Loop)**
 - Ställ in **effekt-börvärde** med röd **Potentiometer (3)** för temperatur.
 - Ställ in **luftmängd-börvärde** med hjälp av blå **Potentiometer (4)** för luftmängd.
- **Extern styrning (Open Loop)**
 - Ställ in **effekt-börvärde** med hjälp av **extern regulator** för temperatur.
 - Ställ in **luftmängd-börvärde** med hjälp av **extern regulator** för luftmängd.

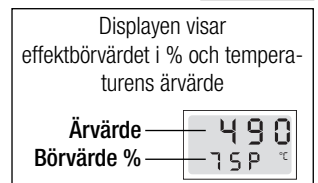

Konfiguration och manövrering HOTWIND SYSTEM

Anslut nätsladden (1) till elnätet.



Huvudströmbrytare (2)

PÅ

Tryck in funktionsknapp (2) 3 sekunder
Meny Setup

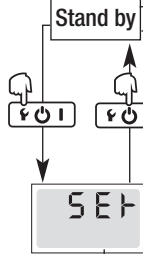

Tryck in funktionsknapp (2) kort 1 x

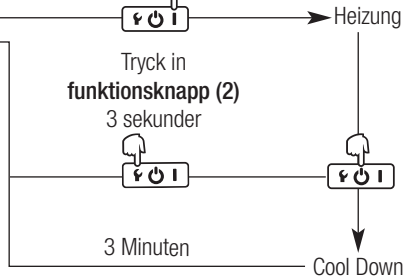

Legende	
Indikering	Beskrivning
Air	Börvärde luftmängd
CEL (°C)	Celsius
CLO (Closed Loop)	Reglerat
CON (Connector)	Gränssnitt
FRF (°F)	Fahrenheit
HER (Heater)	Börvärde uppvärmning
LOO (Loop)	Reglering
OPE (Open Loop)	Styrd
POT (Pot)	Potentiometer
SET (Setup)	Konfiguration
UNI (Unit)	Enhet

Om funktionsknappen (2) inte trycks in under 10 sekunder i menyn Setup växlar apparaten automatiskt till Standby

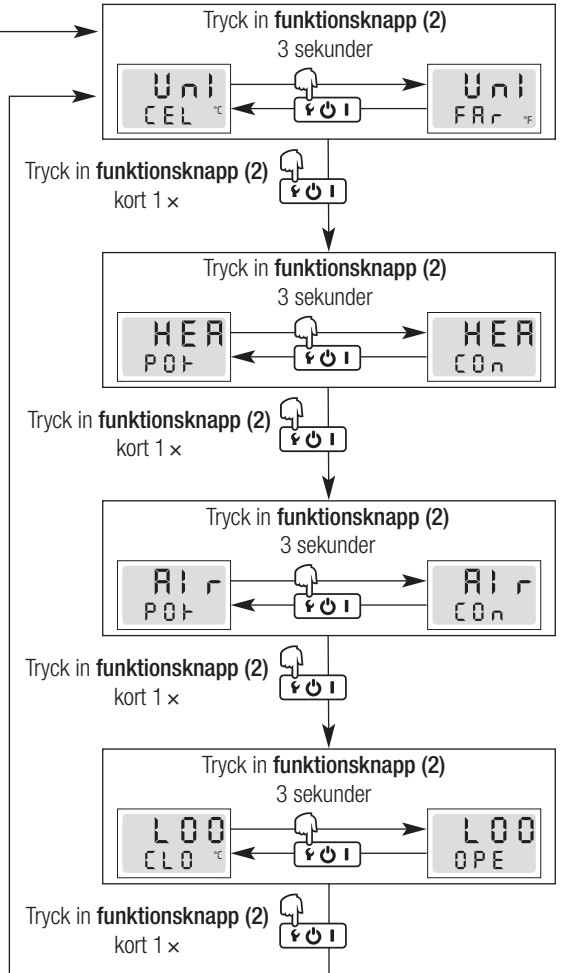

Error

- När en felfunktion inträffar hos apparaten visas ett meddelande som även är försett med en felkod i **displayen (10)**. Den här koden står för en exaktare beskrivning av felet (se tabell).
- Ett fel (Error) kan återställas genom intryckning av **funktionsknappen (2)**  under 3 sekunder (Reset).



Display	Beteckning	Felorsak	Åtgärda felet
Err 01	För hög apparattemperatur	Omgivningstemperatur högre än specificerat	Sänk omgivningstemperatur
		Inluftstemperatur högre än specificerat	Sänk inluftstemperatur
		Luftinlopp blockerat	Kontrollera luftinlopp
		Rostfritt-stålfiler	Rengör Rostfritt-stålfiler
		Luftutlopp blockerat	Kontrollera luftutlopp
		Fel munstycke monterat	Kontrollera munstycke
Err 02	Värmeelementtemperatur för hög	Luftinlopp blockerat	Kontrollera luftinlopp
		Rostfritt-stålfiler	Rengör Rostfritt-stålfiler
		Luftutlopp blockerat	Kontrollera luftutlopp
		Fel munstycke monterat	Byt munstycke
Err 03	Temperatursond	Fel i anslutning temperatursond	Kontrollera temperatursondens anslutning
		Temperatursond defekt	Kontakta Leister serviceställe
Err 04 Err 05 Err 06 Err 07 Err 08	Kontakta Leister serviceställe		

Tillbehör

- **Endast tillbehör från Leister får användas!**

Handle Kit artikelnr. 141.723
Rostfritt-stålfiler artikelnr. 107.248

- Fler tillbehör på www.leister.com

Kurser

- Leister Technologies AG och deras auktoriserade serviceställen erbjuder kostnadsfria svets- och introduktionskurser. Mer information på www.leister.com.

Underhåll

- **Luftinloppet (6)** ska rengöras med en pensel om det är nedsmutsat
- Kontrollera **nätsladd (1)** och stickpropp med avseende på elektriska och mekaniska skador

Service och reparation

- Reparationer får endast utföras av auktoriserade **Leister-serviceställen**. Dessa garanterar en korrekt och tillförlitlig **reparationsservice** med original-reservdelar enligt kopplingsscheman och reservdelslistor inom överskådlig tid.

Garanti

- För denna apparat lämnas en principiell garanti på ett (1) år från inköpsdatum (styrks med faktura eller följesedel). Skador som uppstått avhjälps genom utbyte eller reparation. Värmeelement omfattas inte av denna garanti.
- Andra anspråk är uteslutna, med förbehåll för lagstadgade bestämmelser.
- Skador som uppstår genom naturligt slitage, överbelastning eller icke fackmässig behandling omfattas inte av garantin.
- Inga anspråk gäller för apparater som byggts om eller förändrats av köparen.

HOTWIND sıcak hava bloverini satın aldığınız için tebrik ederiz !

Yüksek kaliteli malzemelerden oluşan birinci sınıf bir sıcak hava bloverini tercih etmiş bulunuyorsunuz. Her HOTWIND cihazı, İsviçre'deki fabrikadan çıkmadan önce katı kalite kontrollerine tabi tutulmaktadır.



Kullanım kılavuzunu, cihazı işleme almadan önce dikkatle okuyun ve daha sonra başvurmak üzere saklayın.

Sıcak hava bloveri HOTWIND PREMIUM, HOTWIND SYSTEM

Kullanım

Sıcak hava bloveri HOTWIND PREMIUM ve HOTWIND SYSTEM, sürekli çalışmaya uygun olarak tasarlanmıştır. Makinelere, tesislere ve cihazlara montaj veya el aleti veya tezgah cihazı olarak kullanım için son derece uygundur.

En önemli kullanım alanları, örneğin kurutma ve ısıtma, buz çözme, hızlandırma ve sökme, sterilize etme, düzleştirme, parlatma, aktive etme ve çözme, ayırma ve birleştirme, büzüştürme, lehimleme, kaynaklama, temizleme ve ateşlemedir.



Uyarı



Elektrik bulunan bileşenler ve bağlantılar açığa çıkacağı için cihaz açılırken **hayati tehlike** vardır. Cihazı açmadan önce elektrik fişini prizden çekin.



Sıcak hava tabancalarının, özellikle yanıcı malzemelerin ve patlayıcı gazların yakınında usulüne uygun olarak kullanılmaması durumunda **yangın ve patlama tehlikesi** vardır.



Yanma tehlikesi ! Sıcak durumdaki ısıtma elemanı borusuna ve memeye dokunmayın. Cihazı soğumaya bırakın. Cihazdan çıkan sıcak havayı insanlara veya hayvanlara doğru tutmayın.



Dikkat



Makinenin üzerinde belirtilen **anma gerilimi**, şebeke gerilimi ile eşdeğer olmalıdır. EN 61000-3-11; $Z_{max} = 0.053 \Omega + j 0.033 \Omega$. Gerektiğinde elektrik dağıtım şirketine danışın.



Cihaz şantiyelerde kullanıldığında, insanları korumak için mutlaka bir **kaçak akım koruma şalteri** gereklidir.



Cihaz, **gözlem altında tutularak** çalıştırılmalıdır. Oluşan ısı, görüş alanının dışında kalan yanıcı malzemelere ulaşabilir.

Cihaz, sadece **eğitilmiş uzman personel** tarafından ve bunların gözetimi altında kullanılmalıdır. Çocuklar tarafından kullanılması kesinlikle yasaktır.



Cihaz, **neme ve suya karşı korunmalıdır**.

Donanım Ekleme Beyanı

(2006/42/AT sayılı AT Makine Emniyeti Yönetmeliği Ek II B uyarınca)

Leister Technologies AG, Galileo-Strasse 10, CH-6056 Kaegiswil/İsviçre, aşağıda adı geçen kısmen tamamlanmış makinenin,

Tanım: **Hot air blower**
Tip: **HOTWIND**
Model: **PREMIUM veya SYSTEM**

– teslimat kapsamı bakımından mümkün olduğu kadar AT Makine Emniyeti Yönetmeliği'nin (2006/42) uygulanabilir temel hükümlerine uygun olduğunu beyan eder.

Kısmen tamamlanmış makine, ayrıca aşağıda belirtilen AT yönetmeliğinin (yönetmeliklerinin) hükümlerine uygundur:

AT yönetmeliği
(yönetmelikleri): Elektromanyetik Uyumluluk 2004/108
Alçak Gerilim Yönetmeliği 2006/95

Harmonize standartlar: EN 12100-1, EN 12100-2, EN 60204-1, EN 14121-1,
EN 55014-1, EN 55014-2, EN 61000-6-2,
EN 61000-3-2, EN 61000-3-3, EN 61000-3-11 (Z_{max})
EN 50366, EN 62233, EN 60335-2-45

Bu kısmen tamamlanmış makine için, EK VII (Bölüm B) uyarınca gerekli özel teknik dosyaların düzenlendiği ve bu teknik dosyaların haklı bir amaçla talep edilmesi halinde pazar denetleme kurumlarına elektronik yolla iletileceğini beyan ediyoruz.

Teknik dosya düzenleyen yetkilinin adı: Patrick Rieder, Compliance Manager

Kısmen tamamlanmış bu makine, ancak monte edileceği makinenin 2006/42/AT sayılı AT Makine Emniyeti Yönetmeliği'nin hükümlerine uygun olduğu tespit edildiğinde işleme alınabilir.

Kaegiswil, 28.11.2011

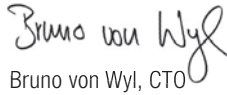
Bruno von Wyl, CTO

Beat Mettler, COO

İmha Edilmesi



Elektrikli aletler, aksesuarlar ve ambalajlar, çevreye uygun bir şekilde geri dönüşüm sistemine dahil edilmelidir. Sadece AB ülkeleri için: Elektrikli ve elektronik aletleri ev çöpüne atmayın! Elektrikli ve elektronik eski cihazlar hakkındaki 2002/96 sayılı Avrupa direktifi ve bu direktifin ulusal yasalar uyarlanmış hali uyarınca kullanılabilir durumda olmayan elektrikli aletler ayrı olarak toplanmalı ve çevreye uygun bir şekilde geri dönüşüm sistemine dahil edilmelidir.

Teknik veriler

Gerilim	V~	120	230	230	230	400
Güç	W	2300	2300	3100	3680	5400
Frekans	Hz	50/60				
Maks. hava çıkış sıcaklığı	°C	650	650	800	650	650
Hava miktarı (20 °C)	l/min.	200 – 900				
Maks. sabit basınç	Pa	820	1050			
Emisyon seviyesi	L_{pA} (dB)	< 70				
Ağırlık Elektrik bağlantı kablosu hariç	kg	2.2	2.2	2.3	2.2	2.4
Ölçü		Sayfa 3 (Boyut)				
Uygunluk işareti		CE				
Emniyet işareti						
Sertifikalandırma türü						
Koruma sınıfı II		□				

Teknik değişiklik yapma hakkı saklıdır
Bağlantı gerilimi değiştirilemez

	PREMIUM	SYSTEM
Isıtma gücü ve hava miktarı, potansiyometre ile kademesiz olarak ayarlanabilir.	•	•
Entegre güç elektroniği	•	•
Isıtma elemanının ve cihazın aşırı ısınmasına karşı koruma	•	•
Alarm çıkışı		•
Entegre termostat		•
Sıcaklık ve güç ayarı için uzaktan kumanda arabirimi		•
Hava miktarı ayarı için uzaktan kumanda arabirimi		•
Entegre sıcaklık sensörü		•
Ayar değerlerinin ve gerçek değerlerin gösterilmesi için ekran (°C veya °F)		•

Arabirim ile İlgili Teknik Veriler

PREMIUM, SYSTEM Röle çıkışı	Maks. gerilimler	AC 250 V, DC 30 V
	Maks. akımlar	AC 3 A, DC 3 A
	Maks. kontak direnci	DC 6 V / 1 A'de 100 m Ohm
	Kontakt türü	SPST - NO
	İzolasyon IEC/EN 60065	AC 2000 V (50-60 Hz) 1 min
SYSTEM Sinyal girişleri Ters kutup koruması ve sıfır nokta düzeltmesi	İzolasyon IEC/EN 60747-5-2	AC 1414 V Peak
	GND iso'ya bağlı gerilim girişi Uc	DC 0- 10 V (5 °C çözünürlükte dalgalanma gerilimi < 0.05 V) (%1 çözünürlükte dalgalanma gerilimi < 0.1 V)
	Maks. giriş gerilimi	DC 12 V
	Anma giriş direnci	280 kOhm
	Akım girişi Ic (2 iletkenli teknik)	DC 4...20 mA (5 °C çözünürlükte dalgalanma gerilimi < 0.1 mA) (%1 çözünürlükte dalgalanma gerilimi < 0.15 mA)
	Maks. giriş akımı	DC 22 mA
	Anma giriş direnci	160 Ohm
	Gerilim beslemesi Sinyal girişlerinin birbirinden ayrılmasına gerek olmadığı ters kutup koruması	GND iso'ya bağlı çalışma gerilimi Uc
Maks. çalışma gerilimi		DC 25 V
Akım çekışı		DC 24 V'ta 12 mA
Open Loop veya Closed Loop	Güç ayar fonksiyonu	Ayar derecesi OFF (KAPALI)...%100; %1'lik adımlar
	Sıcaklık kontrol fonksiyonu	Ayar değeri ayarı 50 °C...650 °C, 5 °C'lik adımlarla
Potansiyometre veya arabirim üzerinden ayar değeri ayarlama	Dahili potansiyometre	Ayar değeri OFF (KAPALI)...100 % veya 50 °C ...650 °C
	Harici arabirim	Ayar değeri OFF (KAPALI)...100 % veya 50 °C ...650 °C

Cihazın Tanıtımı

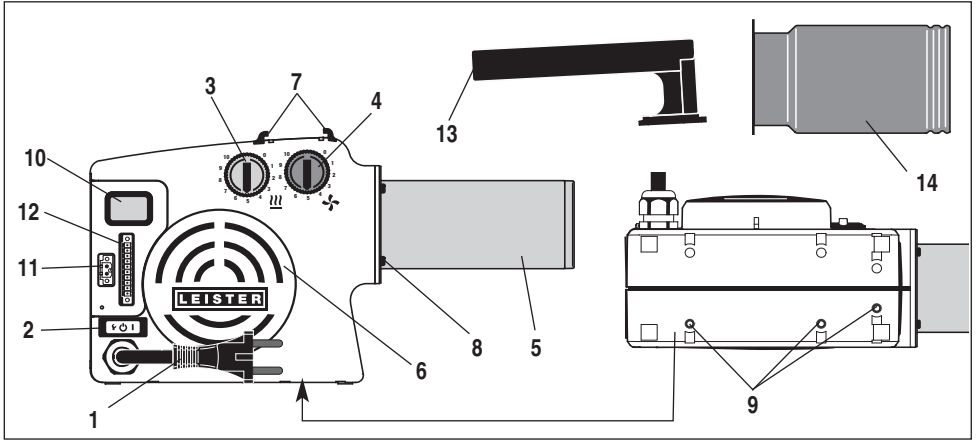

HOTWIND PREMIUM veya SYSTEM

- 1 Elektrik bağlantı kablosu
- 2 Fonksiyon tuşlu ana şalter
- 3 Sıcaklık için potansiyometre (kırmızı)
- 4 Hava miktarı için potansiyometre (mavi)
- 5 Isıtıcı rezistans borusu
- 6 Çelik paslanmaz filtrelili hava giriş flanşı
- 7 Tutamak için tutucu
- 8 Dört adet sabitleme vidası
- 9 Sabitleme ve montaj için üç adet M5 vida bağlantısı

HOTWIND SYSTEM

- 10 Ekran
- 11 Alarm kontağı
- 12 Arabirim

El aleti olarak HOTWIND PREMIUM veya SYSTEM

- 13 Tutamak
- 14 Koruma borusu

Isıtma Elemanı ve Cihaz Koruması Fonksiyonu

- Isıtma elemanı veya cihaz çok ısındığında (çok sıcak emiş havası veya ısı birikmesi), ısıtma elemanının güç beslemesi kesilir ve alarm rölesinin çalışma kontağı açılır. Isıtma elemanı koruması veya cihaz koruma fonksiyonu devreye girdiğinde, emniyet nedenlerinden dolayı HOTWIND cihazının resetlenmesi gerekir. Resetleme işlemi, **fonksiyon tuşu (2)**  üç saniye basılı tutularak yapılır. Emiş havasını kontrol edin (bkz. yapı).

Poyansiyometre ayar değerleri

- Dahili elektronik sistem, maks. hava çıkış sıcaklığını 650 °C ile sınırlar.
- Bunlar, çevre koşullarına ve yapı parçası toleranslarına göre farklılık gösterebilen referans değerlerdir.

Potansiyometre Pozisyon	0	1	2	3	4	5	6	7	8	9	10
Isıtma gücü %	OFF	10	20	30	40	50	60	70	80	90	100
Hava miktarı l/dk.	200	270	340	410	480	550	620	690	760	830	900
Sıcaklık (3680 W) 300 l/dk.'da °C	Çevre	90	150	215	275	340	400	465	525	590	650

Sıcaklık/Hava miktarı grafiği

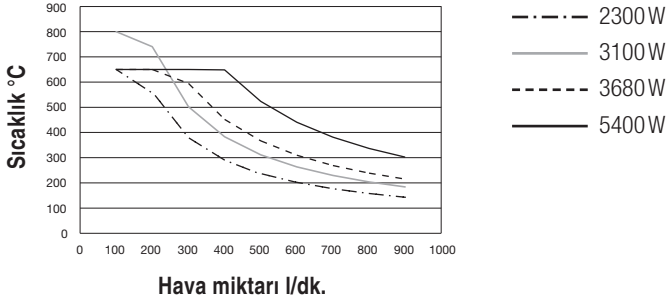

HOTWIND SYSTEM

Arabirim

11 Alarm kontağı

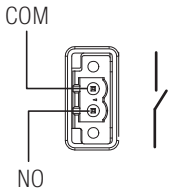

12 Arabirim

Hava miktarı

15-24 VDC
4-20 mA -
4-20 mA +
0-10 V
GND

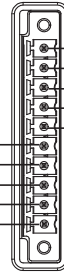

Isıtma gücü

15-24 VDC
4-20 mA -
4-20 mA +
0-10 V
GND

Elektrik şebekesi bağlantısında, elektrik şebekesi ile bağlantıyı tüm kutuplardan kesen **3 mm'lik kontak mesafesine** sahip uygun bir donanım mevcut olmalıdır.

Alarm kontağı: SPST- NO 250 VAC / 30VDC, 3A $\cos \varphi = 1$

HOTWIND SYSTEM Kumanda Sistemi

Input 0-10 V

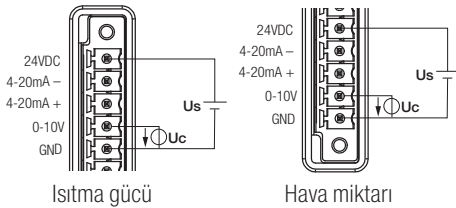

Isıtma gücü

Hava miktarı

Güç f (kumanda gerilimi)

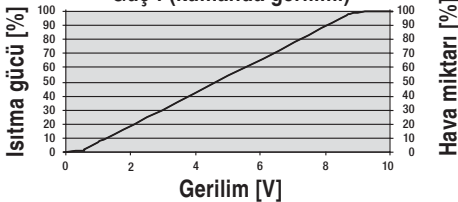

Input 4-20 mA

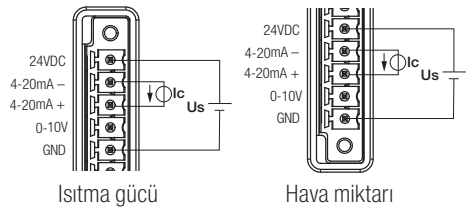

Isıtma gücü

Hava miktarı

Güç f (kumanda akımı)

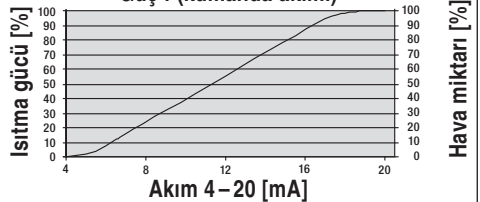

Dikkat: %0'da yaklaşık hava miktarı 200 l/dk.

Elde kullanım seti

- Elde kullanım setinin montajı sadece eğitimli uzman kişilerce veya bunların gözetimi altında yapılmalıdır.
- **Tutamak (13)** ve **koruma borusu (14)** teslimat kapsamına dahil değildir (bkz. Aksesuarlar).



Elde kullanım seti monte edilmeden önce cihaz, **ana şalter (2)** üzerinden kapatılmalı ve soğumaya bırakılmalıdır. Cihaz otomatik olarak kapanır.



Elektrik bağlantı kablosunu (1) elektrik şebekesinden ayırın.

• Elde kullanım setinin montajı

- 1 **Tutamağı (13)** tutucuya (1) takın.
- 2 Dört adet **sabitleme vidasını (8)** çözün (sökmeysin).
- 3 **Koruma borusunu (14) ısıtma elemanı borusunun (5) üzerine geçirin ve sabitleme vidaları (8) için olan deliklerin üzerine getirin.**
- 4 **Koruma borusunu (14)** dayanak noktasına kadar çevirin.
- 5 Dört adet **sabitleme vidasını (8)** sıkın.



Isıtma elemanının değiştirilmesi

- Isıtma elemanı değişimi, sadece eğitimli uzman personel tarafından veya bunların gözetimi altında yapılmalıdır.



1 **Ana şalteri (2)** kapatın ve cihazı soğumaya bırakın. Cihaz otomatik olarak kapanır.



2 **Elektrik bağlantı kablosunu (1)** elektrik şebekesinden ayırın.

3 Dört adet **sabitleme vidasını (8)** sökün. 4 **ısıtma elemanı borusunu (5)** ve ısıtma elemanını sökün.

5 Isıtma elemanını paketten çıkartın. 6 Isıtma elemanını monte edin ve **ısıtma elemanı borusunu (5)** takın.

7 **Isıtma elemanı borusunu (5)** dört adet **sabitleme vidası (8)** ile monte edin.



8 **Elektrik bağlantı kablosunu (1)** elektrik prizine takın. Makinenin üzerinde belirtilen anma gerilimi, şebeke gerilimi ile eşdeğer olmalıdır.

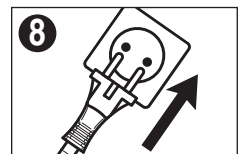
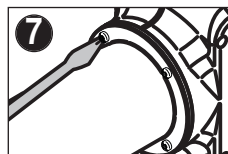
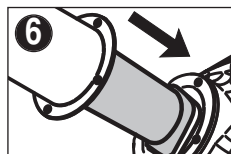
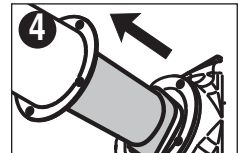
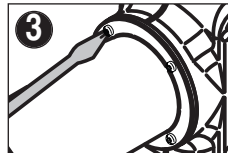
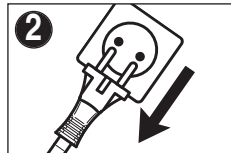
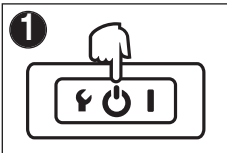

Nozul/Reflektör deęiřimi



Yanma tehlikesi! Sıcak durumdaki ısıtma elemanı borusuna ve memeye dokunmayın.

Nozulu veya reflektörü deęiřtirmeden önce cihazı **ana řalter (2)**  üzerinden kapatın ve soęumaya bırakın. Cihaz otomatik olarak kapanır.

Montaj

- Cihaz, sadece eęitimli uzman kişilerce monte edilmelidir.
- Montaj ölçüsü için bkz. Sayfa 3, Ölçü / Size.



Montajdan önce cihazı **ana řalter (2)**  üzerinden kapatın ve soęumaya bırakın. Cihaz otomatik olarak kapanır.



Elektrik baęlantı kablosunu (1) elektrik řebekesinden ayırın.

- Baęlantı kablolarının, ısıtma elemanı borusuna temas etmemesi ve püskürtülen sıcak havaya maruz kalmaması saęlanmalıdır.
- Cihaz, M5 tipi vidalar kullanılarak **vidalı baęlantılara (9)** sabitlenmelidir.
- Montaj yapıldığında, ařaęıda belirtilen hususlar saęlanmış olmalıdır:
 - Sadece soęuk hava giriři olmalıdır.
 - Geriye doęru ısı birikimi olmamalıdır.
 - Cihaz, bařka bir cihazdan çıkan sıcak havaya maruz bırakılmamalıdır.
- Tozlu hava söz konusu olduęunda Leister paslanmaz çelik filtresini (bkz. Aksesuarlar) kullanın ve **hava giriř flanřının (6)** üzerine takın.
- Özel yapıdaki tozlarda (örneęin metal, elektrięi ileten veya nemli tozlar), cihazda muhtemel kısa devrelerin önlenmesi için özel filtre kullanılmalıdır.
- Cihaz, mekanik titreřimlere ve sarsıntıya karřı korunmalıdır.

Çalıřtırma

- Gerektięinde uygun nozul veya reflektör monte edin.



Sıcak havanın engellenmeden çıkmasına dikkat edilmelidir. Aksi takdirde, oluřabilecek ısı birikimi cihaza zarar verebilir (yangın tehlikesi!).



Elektrik baęlantı kablosunu (1) elektrik prizine takın. Makinenin üzerinde belirtilen anma gerilimi, řebeke gerilimi ile eřdeęer olmalıdır.

- **Ana řalteri (2)**  açın



Cihazı, ısıtma çalıřmasından sonra **ana řalter (2)**  üzerinden kapatın ve soęumaya bırakın. Cihaz otomatik olarak kapanır.



Elektrik baęlantı kablosunu (1) elektrik řebekesinden ayırın.

- **DİKKAT:** Dahili cihaz olarak kullanımında, řebeke baęlantısına, **tüm kutuylar řebekeden ayrılacak řekilde 3 mm'lik kontak mesafesine sahip** uygun bir düzenek bulunmalıdır.

HOTWIND PREMIUM cihazının kullanımı

- Kırmızı **potansiyometri (3)** kullanarak **sıcaklığı** ayarlayın.
- Mavi **potansiyometri (4)** kullanarak **hava miktarını** ayarlayın.

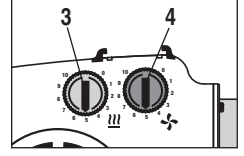

HOTWIND SYSTEM cihazının kullanımı

Potansiyometre

- Kırmızı **potansiyometri (3)** kullanarak **sıcaklığı** ayarlayın.
- Mavi **potansiyometri (4)** kullanarak **hava miktarını** ayarlayın.

Sistem arabirimi

- Sıcaklık ve hava miktarı, **sistem arabirimi (12)** üzerinden kumanda edilebilmektedir. Alarm, cihazın **alarm röle çıkışı (11)** üzerinden bağlanabilmektedir.
Bu durumda, **sıcaklık için olan potansiyometre (3)** ve **hava miktarı (4)** için olan potansiyometre artık çalışmaz.
- Potansiyometre ile arabirim arasında geçiş yapmak için bkz. Yapılandırma, Sayfa 97.

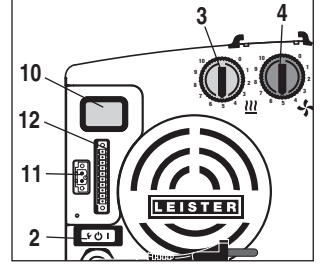

HOTWIND SYSTEM cihazının ekranı (10)

Setup (Yapılandırma) menüsünde, ilgili ayarları yapın (bkz. Sayfa 97).

- **Dahili kontrol (Closed Loop)**
 - Kırmızı **potansiyometri (3)** kullanarak **sıcaklığı** ayarlayın.
 - Mavi **potansiyometri (4)** kullanarak **hava miktarını** ayarlayın.



Ekran, sıcaklık güncel değerleri ve ayar değerleri gösterilir



- **Harici kontrol (Closed Loop)**
 - **Harici ayar elemanı** kullanarak **sıcaklığı** ayarlayın.
 - **Harici ayar elemanı** kullanarak **hava miktarını** ayarlayın.



Ekran, güç ayar değeri % olarak gösterilir ve sıcaklık güncel değeri gösterilir

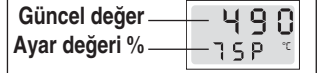

- **Dahili kumanda (Open Loop)**
 - Sıcaklık için olan kırmızı **potansiyometri (3)** kullanarak **güç ayar değerini** ayarlayın.
 - hava miktarı için olan mavi **potansiyometri (4)** kullanarak **hava miktarı ayar değerini** ayarlayın.
- **Harici kumanda (Open Loop)**
 - Sıcaklık için olan **harici kumanda elemanı** kullanarak **güç ayar değerini** ayarlayın.
 - hava miktarı için olan **harici kumanda elemanı** kullanarak **hava miktarı ayar değerini** ayarlayın.

HOTWIND SYSTEM Cihazının Yapılandırılması ve Kullanımı

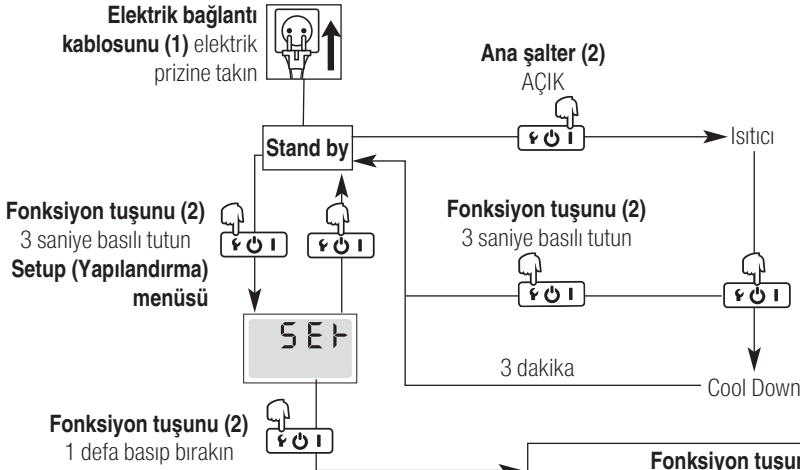

Resim açıklaması

Gösterge	Açıklaması
Rİ r (Air)	Hava miktarı ayar değeri
CEL (°C)	Santigrad
CLD (Closed Loop)	Ayarlandı
CON (Connector)	Arabirim
FRr (°F)	Fahrenheit
HER (Heater)	Isıtma ayar değeri
LOD (Loop)	Ayar
OPE (Open Loop)	Kumanda edildi
POT (Pot)	Potansiyometre
SEt (Setup)	Yapılandırma
Unİ (Unit)	Ünite

Setup (Yapılandırma) menüsündeyken 10 saniye boyunca **fonksiyon tuşuna (2)** basılmadığında cihaz otomatik olarak **bekleme moduna** geçer

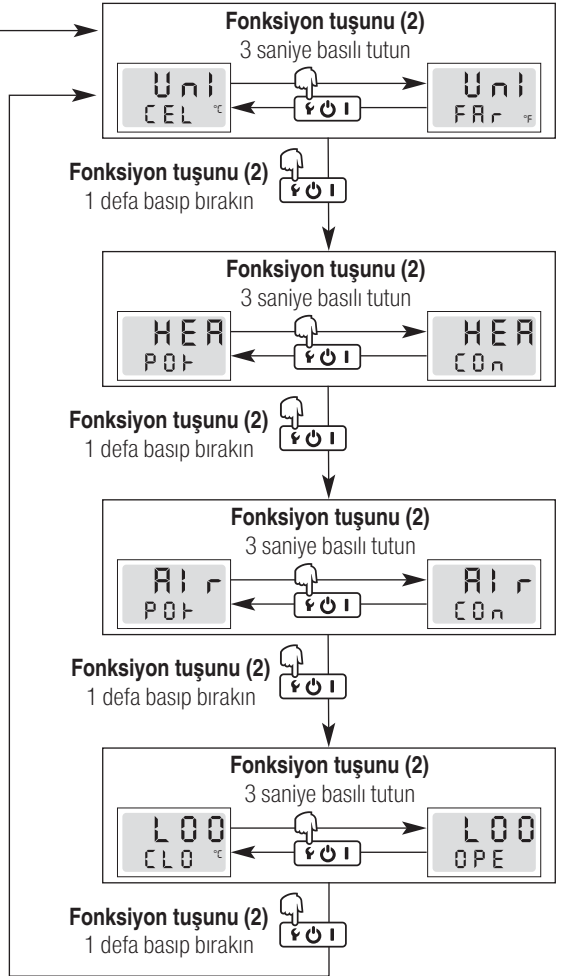

Error

- Cihazda hatalı bir çalışma meydana geldiğinde, **ekranda (10)**, bir hata kodu ile birlikte bir mesaj gösterilir. Bu kod, hatanın tam olarak açıklanmasını sağlar (bkz. Tablo).
- Bir hata, **fonksiyon tuşu (2)**  saniye basılı tutularak resetlenebilir.

Ekran	Tanım	Hatanın nedeni	Hatanın giderilmesi
Err 01	Cihaz sıcaklığı çok yüksek	Çevre sıcaklığı olması gerekenden daha yüksek	Çevre sıcaklığını düşürün
		Emiş havası sıcaklığı olması gerekenden daha yüksek	Giriş havası sıcaklığını düşürün
		Hava girişi bloke oldu	Hava girişini kontrol edin
		Paslanmaz çelik filtre bloke oldu	Paslanmaz çelik filtreyi temizleyin
		Hava çıkışı bloke oldu	Hava çıkışını kontrol edin
		Yanlış nozul monte edildi	Nozulu kontrol edin
Err 02	Isıtıcı eleman sıcaklığı çok yüksek	Hava girişi bloke oldu	Hava girişini kontrol edin
		Paslanmaz çelik filtre bloke oldu	Paslanmaz çelik filtreyi temizleyin
		Hava çıkışı bloke oldu	Hava çıkışını kontrol edin
		Yanlış nozul monte edildi	Nozulu değiştirin
Err 03	Sıcaklık sensörü	Sıcaklık sensörü bağlantısı hatalı	Sıcaklık sensörü bağlantısını kontrol edin
		Sıcaklık sensörü arızalı	Leister yetkili servisine haber verin
Err 04 Err 05 Err 06 Err 07 Err 08	Leister yetkili servisine haber verin		

Aksesuarlar

- **Sadece Leister firmasına ait aksesuarlar kullanılabilir!**

Elde kullanım seti Ürün No. 141.723

Paslanmaz çelik filtre Ürün No. 107.248

- Diğer aksesuarlar için bkz. www.leister.com

Eğitim

- Leister Technologies AG firması ve bu firmanın yetkili servisleri, ücretsiz kaynak kursları ve eğitimler sunmaktadır. Daha fazla bilgi için bkz. www.leister.com.

Bakım

- **Hava girişi (6)**, kirlenme durumunda bir fırça ile temizlenmelidir.
- **Elektrik bağlantı kablosunu (1)** ve fişi, elektriksel ve mekanik hasarlara karşı kontrol edin

Servis ve Onarım

- Onarım çalışmaları sadece **yetkili Leister servisleri** tarafından yapılmalıdır. **Yetkili servisler**, mümkün olan en kısa süre içerisinde, orijinal yedek parçalar kullanılarak devre planlarına ve yedek parça listelerine uygun olarak düzgün ve güvenilir bir şekilde onarım yapılmasını sağlamaktadır.

Garanti

- Cihaz, satın alma tarihinden (Fatura veya sevki irsaliyesi ibrazı şarttır) itibaren 1 yıllık temel bir garantiye sahiptir. Garanti kapsamında meydana gelen hasarlar değişim veya onarım yapılarak giderilir. Isıtma elemanları, bu garanti kapsamına dahil değildir.
- Bunun dışında, yasal düzenlemeler kayda alınmak sureti ile hiçbir hak talep edilemez.
- Doğal aşınma, aşırı zorlanma veya usulüne uygun olmayan kullanım nedeniyle meydana gelmiş olan hasarlar garanti kapsamı dahilinde değildir.
- Müşteri tarafından üzerinde modifikasyon veya değişiklik yapılan cihazlar için hiçbir hak talep edilemez.

Gratulujeme Vám ke koupi přístroje HOTWIND!

Rozhodli jste se pro prvotřídní horkovzdušné dmychadlo od firmy Leister, které je vyrobeno z vysoce jakostních materiálů. Každý HOTWIND je podroben přísné kontrole kvality, dříve než opustí náš podnik ve Švýcarsku.



Před uvedením do provozu si pozorně přečtěte návod k obsluze a uschovejte jej pro další použití.

Horkovzdušné dmychadlo HOTWIND PREMIUM, HOTWIND SYSTEM

Použití

Horkovzdušná dmychadla HOTWIND PREMIUM a HOTWIND SYSTEM jsou konstruována pro nepřetržitý provoz. Výborně se hodí k montáži do strojů, zařízení a přístrojů, anebo slouží jako ruční či stolní přístroje.

K jejich nejdůležitějšímu způsobu použití patří například sušení a ohřívání, rozmrazování, urychlování a rozpouštění, sterilizování, vyhlazování, leštění, aktivování a uvolňování, oddělování a spojování tavením, smršťování, pájení, svařování, odstraňování, zapalování.



Varování



Nebezpečí života při otevírání přístroje z důvodu odkrytí komponent a vývodů pod napětím. Před otevřením přístroje odpojte přívodní kabel ze zásuvky.



Nebezpečí požáru a exploze při neodborném použití horkovzdušných přístrojů, především v blízkosti hořlavých materiálů a výbušných plynů.



Nebezpečí popálení! Nedotýkejte se trubky topného tělesa a trysky v horkém stavu. Přístroj nechte vychladnout. Proud horkého vzduchu nesměřujte na osoby a zvířata.



Pozor



Jmenovité napětí uvedené na přístroji musí souhlasit se sítovým napětím. EN 61000-3-11; $Z_{max} = 0.053 \Omega + j 0.033 \Omega$. Popřípadě konzultujte s dodavatelem elektrické energie.



Při použití přístroje na staveništích je pro ochranu osob bezpodmínečně nutné používat **proudový chránič FI**.



Přístroj musí být provozován **pod dohledem**. Teplo se může rozšířit i k hořlavým materiálům, které jsou mimo dohlednou vzdálenost.

Přístroj smí být používán výhradně **vyškolenými odborníky** anebo pod jejich dohledem. Dětem je použití přístroje zcela zakázáno.



Přístroj **chráňte před vlhkostí a mokrem**.

Prohlášení o montáži

(Ve smyslu směrnice ES pro stroje 2006/42; dodatku II B)

Leister Technologies AG, Galileo-Strasse 10, CH-6056 Kaegiswil / Švýcarsko tímto prohlašuje, že neúplné strojní zařízení

Označení: **Horkovzdušné dmychadlo**

Typ: **HOTWIND**

Provedení: **PREMIUM nebo SYSTEM**

– pokud je to s ohledem na rozsah dodávky možné – odpovídá základním aplikovatelným požadavkům směrnice ES pro stroje (2006/42).

Neúplné strojní zařízení kromě toho odpovídá požadavkům následujících směrnic ES:

Směrnice ES: Směrnice ES o elektromagnetické snášenlivosti 2004/108
Směrnice ES pro nízké napětí 2006/95

Harmonizované normy: EN 12100-1, EN 12100-2, EN 60204-1, EN 14121-1,
EN 55014-1, EN 55014-2, EN 61000-6-2,
EN 61000-3-2, EN 61000-3-3, EN 61000-3-11 (Z_{max})
EN 50366, EN 62233, EN 60335-2-45

Dále prohlašujeme, že pro toto neúplné strojní zařízení byly vytvořeny speciální technické podklady podle dodatku VII (díl B) a zavazujeme se tyto podklady v elektronické podobě poskytnout na základě odůvodněného vyžádání orgánů dozoru nad trhem.

Jméno zplnomocněnce pro dokumentaci: Patrick Rieder, Compliance Manager

Uvedení neúplného strojního zařízení do provozu je zakázáno do té doby, než bude konstatováno, že stroj, do kterého bylo neúplné strojní zařízení zabudováno, odpovídá ustanovením směrnice ES pro stroje (2006/42).

Kaegiswil, 28.11.2011

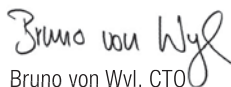
Bruno von Wyl, CTO

Beat Mettler, COO

Likvidace odpadu



Elektrická nářadí, příslušenství a obaly odevzdejte k recyklaci. Jen pro státy EU: Nevyhazujte elektrická nářadí do domovního odpadu! Podle evropské směrnice 2002/96 o opotřebovaných elektrických a elektronických přístrojích a jejího uplatnění v národním právu musí být dále neupotřebitelná elektrická nářadí shromažďována odděleně a odevzdána k recyklaci.

Technické údaje

Napětí	V~	120	230	230	230	400
Výkon	W	2300	2300	3100	3680	5400
Frekvence	Hz	50/60				
Max. teplota vystupujícího vzduchu	°C	650	650	800	650	650
Průtok vzduchu (20 °C)	l/min.	200 – 900				
Max. statický tlak	Pa	820	1050			
Hladina hluku	L_{pA} (dB)	< 70				
Hmotnost bez síťového přívodního kabelu	kg	2.2	2.2	2.3	2.2	2.4
Rozměry	strana 3 (Size)					
Značka konformity	CE					
Bezpečnostní značka						
Druh certifikace						
Třída ochrany II	☐					
Technické změny vyhrazeny						
Napájecí napětí není přepínatelné						

	PREMIUM	SYSTEM
Topný výkon a průtok vzduchu plynule regulovatelné potenciometrem.	•	•
Integrovaná ovládací elektronika	•	•
Ochrana topného tělesa a přístroje proti přehřátí	•	•
Výstup alarmu		•
Integrovaný regulátor teploty		•
Rozhraní dálkového ovládání pro nastavení teploty a výkonu		•
Rozhraní dálkového ovládání pro nastavení průtoku vzduchu		•
Integrovaná teplotní sonda		•
Displej pro zobrazení požadovaných a skutečných hodnot (°C nebo °F)		•

Technické údaje rozhraní

PREMIUM, SYSTEM Výstup relé	Max. napětí	AC 250 V, DC 30 V
	Max. proudy	AC 3 A, DC 3 A
	Max. odpor kontaktů	100 m Ohm při DC 6 V / 1 A
	Druh kontaktu	SPST - NO
	Izolace IEC/EN 60065	AC 2000 V (50-60 Hz) 1 min
SYSTEM Signální vstupy s ochranou proti přepólování a korekcí nulového bodu	Izolace IEC/EN 60747-5-2	AC 1414 V Peak
	Napěťový vstup U_c vztažený na GND iso	DC 0 - 10 V (zvlnění < 0.05 V při rozlišení 5 °C) (zvlnění < 0.1 V při rozlišení 1 %)
	Max. vstupní napětí	DC 12 V
	Jmenovitý vstupní odpor	280 kOhm
	Proudový vstup I_c (2 vodičová technika)	DC 4...20 mA (zvlnění < 0.1 mA při rozlišení 5 °C) (zvlnění < 0.15 mA při rozlišení 1 %)
	Max. vstupní proud	DC 22 mA
	Jmenovitý vstupní odpor	160 Ohm
	Napájení s ochranou proti přepólování bez oddělení od signálních vstupů	Provozní napětí U_s vztažené na GND iso
Max. provozní napětí		DC 25 V
Příkon proudu		12 mA při DC 24 V
Open Loop nebo Closed Loop	Nastavovací funkce výkonu	Stupeň nastavení OFF... 100 %; 1% kroky
	Regulační funkce teploty	Zadání požadované hodnoty 50 °C...650 °C, 5 °C kroky)
Zadání požadovaných hodnot potenciometrem nebo rozhraním	Interní potenciometr	Požadovaná hodnota OFF... 100 %; 50 °C ...650 °C
	Externí rozhraní	Požadovaná hodnota OFF... 100 %; 50 °C ...650 °C

Popis přístroje

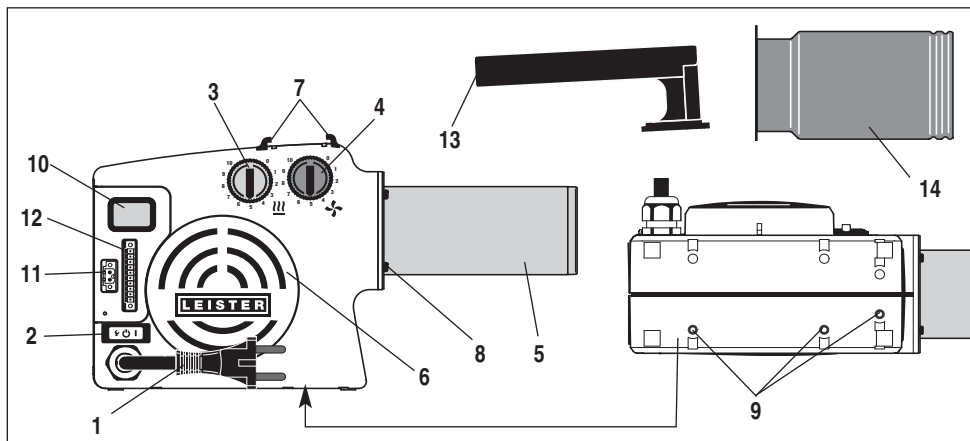

HOTWIND PREMIUM nebo SYSTEM

- 1 Přívodní síťový kabel
- 2 Hlavní vypínač s funkčním tlačítkem
- 3 Potenciometr pro regulaci teploty (červený)
- 4 Potenciometr pro regulaci průtoku vzduchu (modrý)
- 5 Trubka topného tělesa
- 6 Příruba nerezového filtru na přívodu vzduchu
- 7 Úchyt rukojeti
- 8 Čtyři upevňovací šrouby
- 9 Tři závitové vložky M5 pro připevnění v případě montáže

HOTWIND SYSTEM

- 10 Displej
- 11 Kontakt alarmu
- 12 Rozhraní

Ruční přístroj HOTWIND PREMIUM nebo SYSTEM

- 13 Rukojet'
- 14 Ochranná trubice

Funkce ochrany topného tělesa a přístroje

- Přehřeje-li se topné těleso nebo přístroj (příliš horký přívodní vzduch nebo hromadění tepla), přeruší se přívod energie k topnému tělesu a činný kontakt poplašného relé se otevře. Pokud se spustí ochrana topného prvku nebo přístroje, je z bezpečnostních důvodů nutné zpětné nastavení (reset) přístroje HOTWIND. To se provede stisknutím **funkčního tlačítka (2)** po dobu tří sekund. Zkontrolujte nasávaný vzduch (viz montáž).



Hodnoty nastavované potenciometrem

- Interní elektronika omezuje maximální teplotu vystupujícího vzduchu na 650 °C.
- Jsou to směrné hodnoty, které se mohou z důvodu okolních podmínek a tolerancí rozměrů součástek lišit.

Poloha potenciometru	0	1	2	3	4	5	6	7	8	9	10
Topný výkon %	OFF	10	20	30	40	50	60	70	80	90	100
Průtok vzduchu l/min	200	270	340	410	480	550	620	690	760	830	900
Teplota (3680 W) při 300 l/min °C	Okolí	90	150	215	275	340	400	465	525	590	650

Graf teploty / průtoku vzduchu

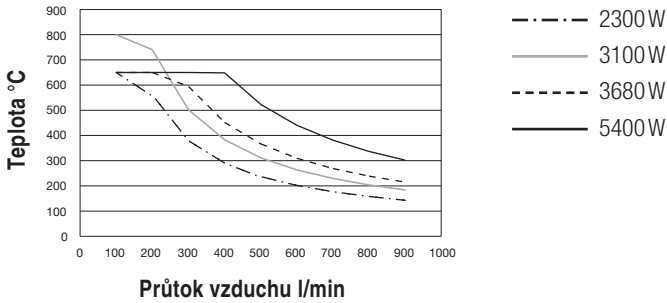

HOTWIND SYSTEM

Rozhraní

11 Kontakt alarmu

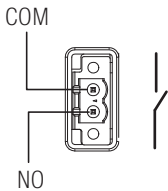

12 Rozhraní

Průtok vzduchu

15-24 VDC
4-20 mA -
4-20 mA +
0-10 V
GND

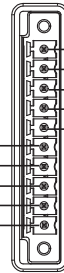

Topný výkon

15-24 VDC
4-20 mA -
4-20 mA +
0-10 V
GND

V síťové přípojce musí být nainstalováno vhodné zařízení pro odpojení od el. sítě ve všech pólech se vzdáleností kontaktů 3 mm.

Kontakt alarmu: SPST-NO 250 VAC / 30 VDC, 3 A $\cos \varphi = 1$

Regulace HOTWIND SYSTEM

Input 0-10 V

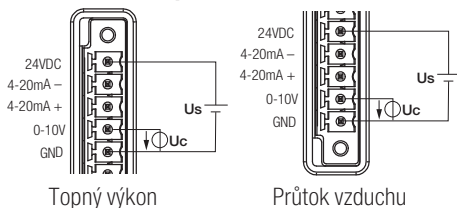

Topný výkon

Průtok vzduchu

Příkon f (řídící napětí)

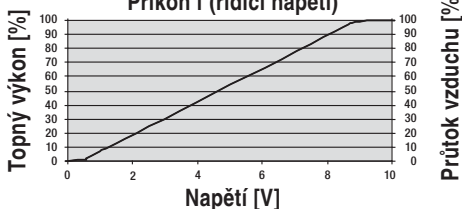

Input 4-20 mA

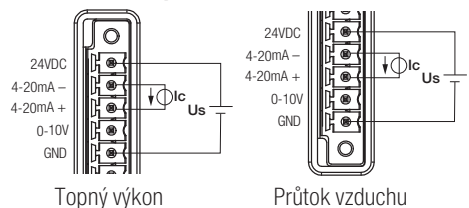

Topný výkon

Průtok vzduchu

Příkon f (řídící proud)

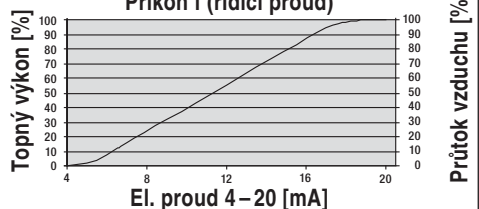

Pozor: Při 0 % průtoku vzduchu cca 200 l/min

Sada pro ruční použití

- Montáž sady pro ruční použití smí být provedena výhradně vyškolenými odborníky anebo pod jejich dohledem.
- **Rukojeť (13)** a **ochranná trubka (14)** nejsou obsaženy v dodávce (viz příslušenství).



Před montáží sady pro ruční použití vypněte přístroj **hlavním vypínačem (2)** a nechte jej vychladnout. Přístroj se automaticky vypne.



Vytáhněte **přívodní síťový kabel (1)** z elektrické sítě.

• Montáž sady pro ruční použití

- 1 Nasuňte **rukojeť (13)** do **úchyty (7)**.
- 2 Uvolněte čtyři **upevňovací šrouby (8)** (neodstraňovat).
- 3 Nasaďte **ochrannou trubku (14)** na **trubku topného tělesa (5)** a najed'te s ní do otvorů pro **upevňovací šrouby (8)**.
- 4 **Ochrannou trubku (14)** otočte až na doraz.
- 5 Utáhněte čtyři **upevňovací šrouby (8)**.



Výměna topného tělesa

- Výměna topného tělesa smí být prováděna výhradně **vyškolenými odborníky** anebo pod jejich dohledem.



1 Vypněte **hlavní vypínač (2)** a nechte přístroj vychladnout. Přístroj se automaticky vypne.



2 Vytáhněte **přívodní síťový kabel (1)** z elektrické sítě.

3 Odstraňte **čtyři upevňovací šrouby (8)**. 4 Odstraňte **trubku topného tělesa (5)** a topné těleso.

5 Vyměňte topné těleso z obalu. 6 Namontujte topné těleso a nasad'te **trubku topného tělesa (5)**.

7 **Trubku topného tělesa (5)** přišroubujte **čtyřmi upevňovacími šrouby (8)**.

8 Zapojte **přívodní síťový kabel (1)** do elektrické sítě. Jmenovité napětí uvedené na přístroji musí souhlasit se síťovým napětím.

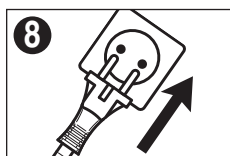
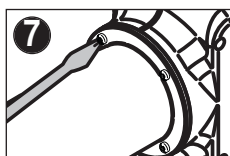
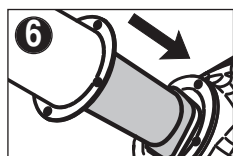
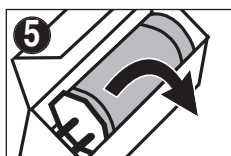
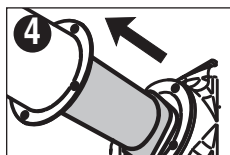
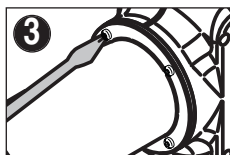
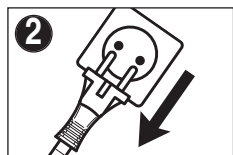
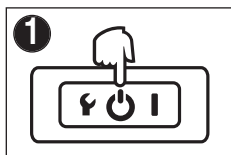

Výměna trysky / reflektoru



Nebezpečí popálení! Nedotýkejte se trubky topného tělesa a trysky v horkém stavu.

Při výměně trysky nebo reflektoru nejprve **hlavním vypínačem (2)**  vypněte přístroj a nechte jej vychladnout. Přístroj se automaticky vypne.

Montáž

- Přístroj smí montovat výhradně vyškolení odborníci.
- Montážní rozměry viz strana 3, Rozměry/Size.



Před montáží vypněte přístroj **hlavním vypínačem (2)**  a nechte jej vychladnout. Přístroj se automaticky vypne.



Vytáhněte **přívodní síťový kabel (1)** z elektrické sítě.

- Zajistěte, aby se přívodní vedení nedotýkala trubky topného tělesa a nebyla vystavena proudu horkého vzduchu.
- Přístroj musí být připevněn pomocí třech M5 šroubů v místě **závitových vložek (9)**.
- Montáž musí zajistit, aby
 - byl přiváděn pouze studený vzduch
 - nedocházelo k hromadění tepla
 - se přístroj nacházel mimo proud horkého vzduchu z jiného přístroje.
- V prašném prostředí používejte nerezový filtr Leister (viz příslušenství), který nasadíte na **přírubu nerezového filtru (6)**.
- U obzvláště kritického prachu (např. kovový, elektricky vodivý nebo vlhký prach) musíte použít speciální filtry, abyste zabránili zkratům v přístroji.
- Přístroj chraňte před mechanickými vibracemi a otřesy.

Provoz

- V případě potřeby namontujte vhodnou trysku nebo reflektor.



Dbejte na to, aby mohl horký vzduch volně proudit ven, jinak by mohlo z důvodu hromadění tepla dojít k poškození přístroje (nebezpečí požáru!).



Zapojte **přívodní síťový kabel (1)** do elektrické sítě. Jmenovité napětí uvedené na přístroji musí souhlasit se sítovým napětím.

- Zapněte **hlavní vypínač (2)** .



Po ukončení provozu vypněte přístroj **hlavním vypínačem (2)**  a nechte jej vychladnout. Přístroj se automaticky vypne.



Vytáhněte **přívodní síťový kabel (1)** z elektrické sítě.

- **POZOR:** Při použití ve formě vestavěného přístroje musí být v síťové přípojce nainstalováno vhodné zařízení pro odpojení od el. sítě ve všech pólech se vzdáleností kontaktů 3 mm.

Obsluha HOTWIND PREMIUM

- Nastavte **teplotu** červeným **potenciometrem (3)**.
- Nastavte **průtok vzduchu** modrým **potenciometrem (4)**.

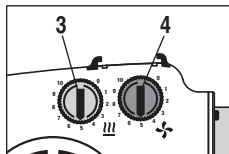

Obsluha HOTWIND SYSTEM

Potenciometr

- Nastavte **teplotu** červeným **potenciometrem (3)**.
- Nastavte **průtok vzduchu** modrým **potenciometrem (4)**.

Systémové rozhraní

- Teplotu a průtok vzduchu lze regulovat přes **systémové rozhraní (12)**. Alarm lze připojit prostřednictvím **výstupního relé alarmu (11)** přístroje.

Potenciometr pro regulaci teploty (3) a potenciometr pro **regulaci průtoku vzduchu (4)** jsou potom bez funkce.

- Pro přepínání mezi potenciometrem a rozhraním viz Konfigurace na straně 109.

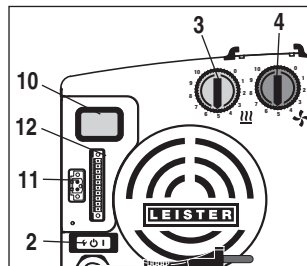

Displej (10) HOTWIND SYSTEM

V menu Setup proveďte příslušná nastavení (viz strana 109).

- **Interní regulace (Closed Loop)**
 - Nastavte **teplotu** červeným **potenciometrem (3)**.
 - Nastavte **průtok vzduchu** modrým **potenciometrem (4)**.
- **Externí regulace (Closed Loop)**
 - Nastavte **teplotu externím regulátorem**.
 - Nastavte **průtok vzduchu externím regulátorem**.

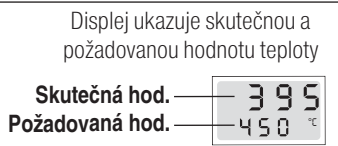

- **Interní řízení (Open Loop)**
 - Nastavte **požadovanou hodnotu výkonu** červeným **potenciometrem (3)** pro regulaci teploty.
 - Nastavte **požadovanou hodnotu průtoku vzduchu** modrým **potenciometrem (4)** pro regulaci průtoku vzduchu.
- **Externí řízení (Open Loop)**
 - Nastavte **požadovanou hodnotu výkonu externím regulátorem** pro regulaci teploty.
 - Nastavte **požadovanou hodnotu průtoku vzduchu externím regulátorem** pro regulaci průtoku vzduchu.

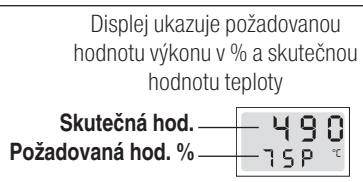

Konfigurace a obsluha HOTWIND SYSTEM

Zapojte **přívodní síťový kabel (1)** do elektrické sítě.

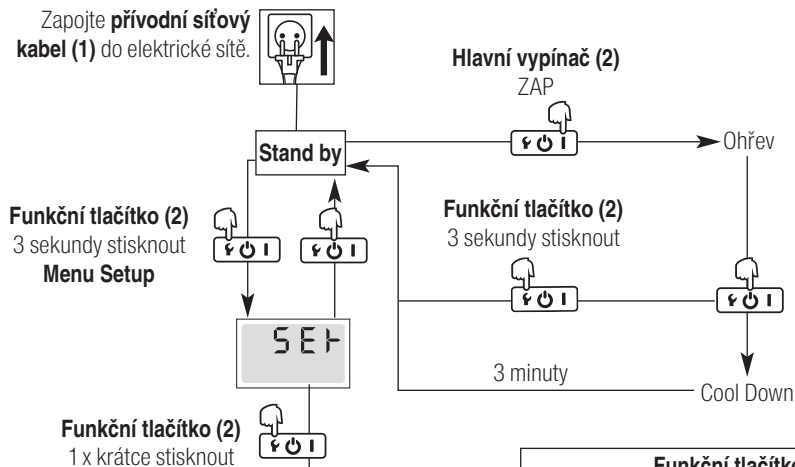

Legenda

Zobrazení	Popis
Ri r (Air)	Požadovaná hodnota průtoku vzduchu
CEL (°C)	Stupně Celsia
CLG (Closed Loop)	Regulováno
CON (Connector)	Rozhraní
FRr (°F)	Stupně Fahrenheita
HER (Heater)	Požadovaná hodnota ohřevu
LOG (Loop)	Regulace
OPE (Open Loop)	Řízeno
POT (Pot)	Potenciometr
SET (Setup)	Konfigurace
Uni (Unit)	Jednotka

Pokud nebude v **menu Setup** po dobu 10 sekund stisknuto žádné **funkční tlačítko (2)**, přepne se přístroj automaticky do **úsporného režimu (stand by)**

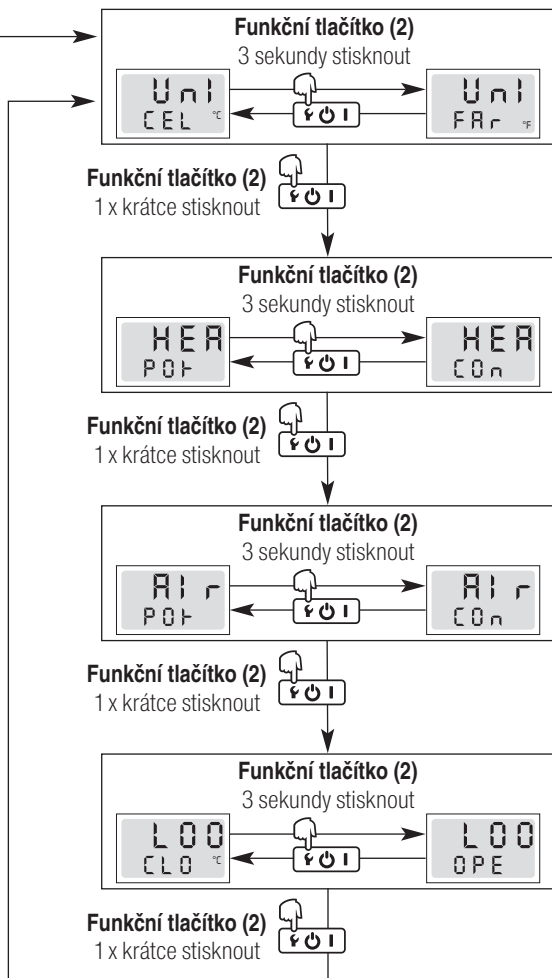

Error

- Dojde-li k chybné funkci přístroje, objeví se na **displeji (10)** hlášení, opatřené navíc kódem chyby (Error). Tento kód odpovídá přesnějšímu popisu chyby (viz tabulka).
- Error lze stisknutím **funkčního tlačítka (2)**  po dobu tří sekund vynulovat (Reset).

Displej	Význam	Příčina chyby	Odstranění chyby
Err 01	Teplota přístroje příliš vysoká	Okolní teplota větší než specifikováno	Snižte okolní teplotu
		Teplota přívodního vzduchu větší než specifikováno	Snižte teplotu přívodního vzduchu
		Přívod vzduchu blokováno	Zkontrolujte přívod vzduchu
		Nerezový filtr blokováno	Vyčistěte nerezový filtr
		Výstup vzduchu blokováno	Zkontrolujte výstup vzduchu
		Namontována nesprávná tryska	Zkontrolujte trysku
Err 02	Teplota topného tělesa příliš vysoká	Přívod vzduchu blokováno	Zkontrolujte přívod vzduchu
		Nerezový filtr blokováno	Vyčistěte nerezový filtr
		Výstup vzduchu blokováno	Zkontrolujte výstup vzduchu
		Namontována nesprávná tryska	Vyměňte trysku
Err 03	Teplotní sonda	Chybné připojení teplotní sondy	Zkontrolujte připojení teplotní sondy
		Teplotní sonda defektní	Kontaktujte servisní středisko firmy Leister
Err 04 Err 05 Err 06 Err 07 Err 08	Kontaktujte servisní středisko firmy Leister		

Příslušenství

- **Je povoleno používat výhradně příslušenství firmy Leister!**

Sada pro ruční použití Č. výrobku 141.723

Nerezový filtr Č. výrobku 107.248

- Další příslušenství najdete na www.leister.com

Školení

- Leister Technologies AG a jejich autorizovaná servisní střediska nabízejí bezplatné svařovací kurzy a výcviky. Informace na www.leister.com.

Údržba

- **Přívod vzduchu (6)** je při znečištění třeba vyčistit štětečkem
- Zkontrolujte případné elektrické a mechanické poškození **přívodního síťového kabelu (1)** a zástrčky

Servis a opravy

- Opravy zadávejte výhradně autorizovaným **servisním střediskům firmy Leister**. Tato servisní střediska zaručují v krátkých lhůtách odborný a spolehlivý **opravářský servis** za použití originálních náhradních dílů podle schémat zapojení a seznamů náhradních dílů.

Záruka

- Na tento přístroj je poskytnuta základní záruka jeden (1) rok od data nákupu (doložení fakturou nebo dodacím listem). Vzniklé škody budou odstraněny náhradního dodání nebo opravou. Topná tělesa jsou z této záruky vyloučena.
- Další nároky jsou, při dodržení zákonných ustanovení, vyloučeny.
- Škody, vycházející z přirozeného opotřebení, nadměrného zatěžování či neodborné manipulace, jsou ze záruky vyloučeny.
- Nárok na záruku zaniká u přístrojů, které byly kupcem přestavěny nebo pozměněny.

欢迎您购买 HOTWIND!

您将从 Leister 得到一台由高品质材料制成的一流热风鼓风机。每台 HOTWIND 在离开瑞士工厂之前都已经进行了严格的质检。



投入运行前请您仔细阅读本使用手册并妥善保管以备使用。

热风鼓风机**HOTWIND PREMIUM, HOTWIND SYSTEM****应用**

热风鼓风机 HOTWIND PREMIUM 和 HOTWIND SYSTEM 均适用于持续运行。将其安装在机器、机组和设备中表现异常出色，同时也可用作手动设备和桌面设备。

其主要可用于干燥、预热、熔融、加速溶解、杀菌、磨平、上光、活化溶解、分离熔化、热收缩、钎焊、焊接、清除和点火。

**警告**

打开设备时，带电元件和接头显露可导致**生命危险**。



热风设备使用不当，尤其是在可燃物和易爆气体附近使用时有造成**火灾和爆炸的危险**。



燃烧危险！不要触摸热的加热管元件和喷嘴。冷却设备。热空气射流切勿指向人或动物。

**注意**

所设定的设备**额定电压**务必要与电源电压保持一致。EN 61000-3-11; $Z_{max} = 0.053 \Omega + j 0.033 \Omega$ 。必要时请咨询电力供应公司。



在施工现场使用设备时，为确保人员安全，必须使用**漏电保护装置**。



设备**运行时必须进行监控**。热气可能喷到视线之外的可燃物上。只能由**受过培训的专业人员**或在其监督下操作设备。儿童不得使用该设备。



注意设备应**防潮防湿**。

安装声明

(根据欧盟机械指令 2006/42; 附录 II B)

Leister Technologies AG, Galileo-Strasse 10, CH-6056 Kaegiswil / 瑞士 特此申明, 不完整的机器

名称: **Hot air blower**
型号: **HOTWIND**
规格: **PREMIUM or SYSTEM**

- 只要属于供货范围, 就一定符合欧盟机械指令 (2006/42) 可适用性的基本要求。

此外, 不完整的机器还符合以下欧盟指令的要求:

欧盟指令: 电磁兼容指令 2004/108
低电压指令 2006/95

协调标准: EN 12100-1, EN 12100-2, EN 60204-1, EN 14121-1,
EN 55014-1, EN 55014-2, EN 61000-6-2,
EN 61000-3-2, EN 61000-3-3, EN 61000-3-11 (Z_{max})
EN 50366, EN 62233, EN 60335-2-45

此外, 我们申明, 不完整的机器均已根据附录 VII (B 部分) 创建了专用技术文档, 并承诺在合理基础上为市场监管机构提供电子版本。

文档授权人的姓名: Patrick Rieder, 合规经理

除非已可以确定安装了不完整机器的设备符合欧盟机械指令 (2006/42) 的规定, 否则禁止将不完整的机器投入运行。

Kaegiswil, 2011/11/28

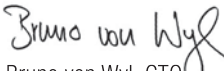
Bruno von Wyl, CTO

Beat Mettler, COO

回收



电动工具、配件和包装应可以进行环保回收。仅限欧盟国家: 切勿将电动工具扔在生活垃圾中! 按照欧洲有关旧电气和电子设备的规定 2002/96 以及所执行的国内法律, 损坏的电气工具必须分开收集并进行环保回收。

技术参数

电压	V~	120	230	230	230	400
功率	W	2300	2300	3100	3680	5400
频率	Hz	50/60				
排气口最高温度	°C	650	650	800	650	650
气量 (20 °C)	l/min.	200 – 900				
最大静态压力	Pa	820	1050			
发射声压级	L _{pA} (dB)	< 70				
重量 不含电源连接线	kg	2.2	2.2	2.3	2.2	2.4
质量	第 3 页 (尺寸)					
市场准入标志	CE					
安全标记						
认证类型						
防护等级 II	□					

保留技术更改权利。

连接电压不可变

	PREMIUM	SYSTEM
加热功率和气量可用电位计无级调节	•	•
集成导电电子部件	•	•
防止加热元件和设备过热	•	•
警报输出端		•
集成温度调节器		•
用于温度或功率预设的远程控制接口		•
用于气量预设的远程控制接口		•
集成温度探头		•
显示额定值和实际值的显示屏 (°C 或 °F)		•

接口技术参数

PREMIUM, SYSTEM 继电器输出端	最大电压	AC 250V, DC 30V
	最大电流	AC 3A, DC 3A
	最大接触电阻	100m Ω , 当电压和电流为 DC 6V / 1A 时
	接触类型	SPST - NO
	IEC/EN 60065 标准绝缘	AC 2000V (50 - 60Hz) 1 min

SYSTEM 信号输入端 带反极性保护和零点修正	IEC/EN 60747-5-2 标准绝缘	AC 1414V _{Peak}
	与 GND iso 相关的电压输入 U _c	DC 0 - 10V (波纹电压 < 0.05V, 当 5°C 时溶解) (波纹电压 < 0.1V, 当 1% 时溶解)
	最大输入电压	DC 12V
	额定输入电阻	280k Ω
	电流输入 I _c (两线制技术)	DC 4...20mA (波纹电流 < 0.1mA, 当 5°C 时溶解) (波纹电流 < 0.15mA, 当 1% 时溶解)
	最大输入电流	DC 22mA
	额定输入电阻	160 Ω
供电 带反极性保护无需断开信号 输入端	与 GND iso 相关的工作电压 U _s	DC 15...24V
	最大工作电压	DC 25V
	电流消耗	12mA bei DC 24V

开环或闭环	功率调控功能	调控幅度 关...100%; 每步 1%
	温度调节功能	预设额定值 50°C...650°, 每步 5°C
额定值预设电位计或接口	内部电位计	额定值 关...100% 或 50°C...650°C
	外部接口	额定值 关...100% 或 50°C...650°C

设备描述

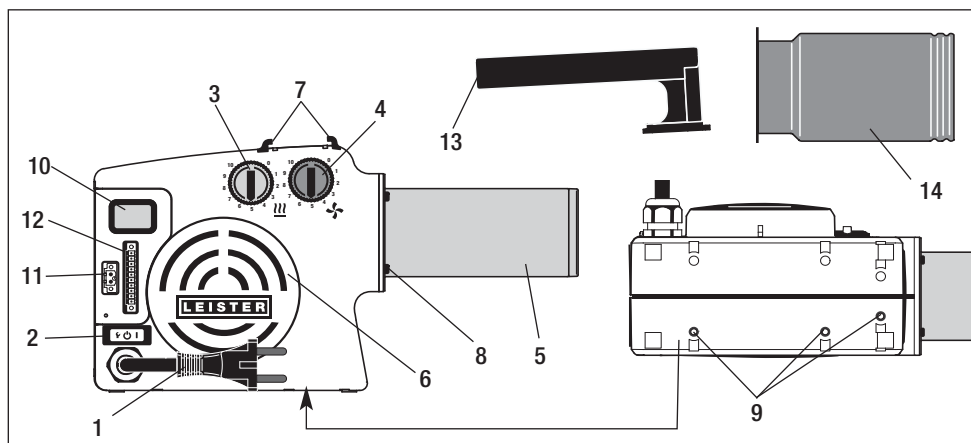

HOTWIND PREMIUM 或 SYSTEM

- 1 电源连接线
- 2 带功能键的主开关
- 3 温度电位计（红色）
- 4 气量电位计（蓝色）
- 5 加热管元件
- 6 不锈钢过滤器的进气法兰
- 7 把手支架
- 8 四枚紧固螺栓
- 9 三个螺纹插入件 M5，用于紧固设备

HOTWIND SYSTEM

- 10 显示屏
- 11 警报触点
- 12 接口

HOTWIND PREMIUM 或 SYSTEM 手动设备

- 13 把手
- 14 防护管

热元件和设备保护装置功能

- 如果加热元件或设备过热（吸入空气或倒流热气过热），则中断加热元件的供电并打开警报继电器的工作触点。

如果加热元件或设备保护装置响应，出于安全原因，必须复位 (Reset) HOTWIND。可通过按下功能键 (2)  在三秒内进行操作。

检查吸入空气（参见安装）。

电位计额定值

- 内部电子设备排气口的最高温度应限制在 650°C。
- 这只是参考值，由于环境条件和部件公差可能会有所偏差。

电位计位置	0	1	2	3	4	5	6	7	8	9	10
加热功率 %	关	10	20	30	40	50	60	70	80	90	100
气量 l/min	200	270	340	410	480	550	620	690	760	830	900
温度 (3680 W) 当 300 l/min 时 °C	环境温度	90	150	215	275	340	400	465	525	590	650

温度/气量图表

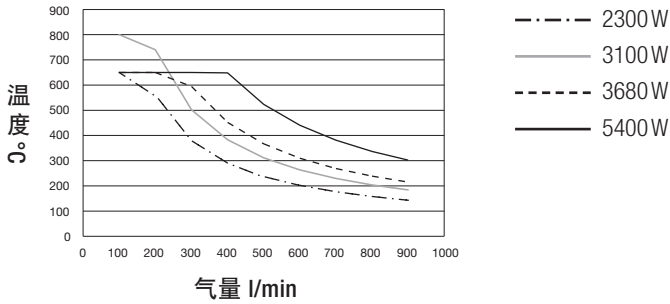

HOTWIND SYSTEM

接口

11 警报触点

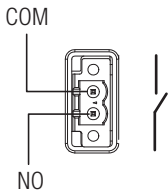

12 接口

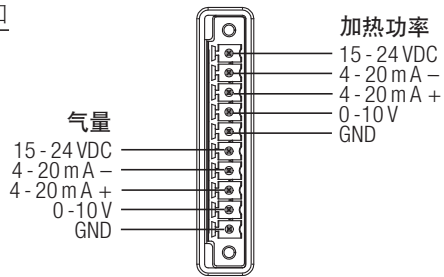

连接电源时必须使用合适的装置在距离触点 3 mm 的地方全极断开电网。

警报触点：SPST-NO 250 VAC / 30 VDC, 3A $\cos \varphi = 1$

HOTWIND SYSTEM 控制系统

输入 0-10V

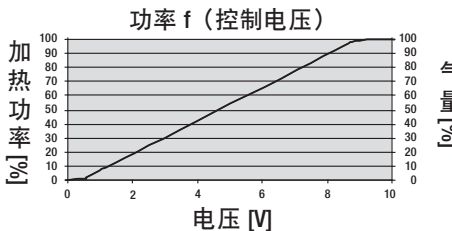
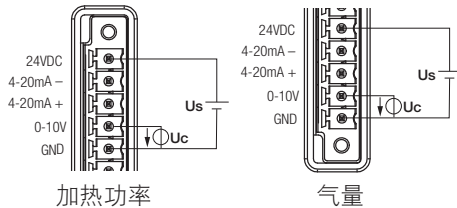

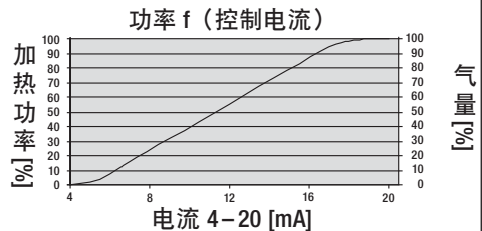
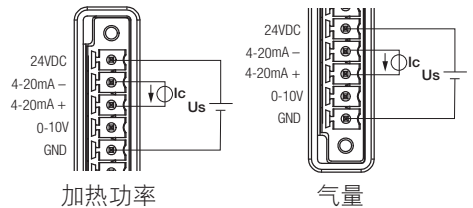

输入 4-20mA



注意：0% 时，气量约为 200 l/min

把手套件

- 只能由受过培训的专业人员或在其监督下安装把手套件。
- 把手 (13) 和防护管 (14) 并不包含在供货范围内 (参见配件)。

 安装把手套件之前应借助总开关 (2)  切断设备并使其冷却。设备自动关闭。

 电源连接线 (1) 应与电网断开。

• 安装把手套件

- ① 将把手 (13) 推到支架 (7) 上。
- ② 松动四枚紧固螺栓 (8) (不需移除)。
- ③ 将防护管 (14) 推到加热管元件 (5) 上, 并在开口中旋入紧固螺栓 (8)。
- ④ 将防护管 (14) 旋至止挡位置。
- ⑤ 拧紧四枚紧固螺栓 (8)。



加热元件更换

- 只能由受过培训的专业人员或在其监督下更换加热元件。

①  切断总开关 (2) 并冷却设备。设备自动关闭。

②  电源连接线 (1) 应与电网断开。

③ 移除四枚紧固螺栓 (8)。 ④ 移除加热管元件 (5) 和加热元件。

⑤ 从包装中取出加热元件。 ⑥ 安装加热元件并推开加热管元件 (5)。

⑦ 将加热管元件 (5) 用四枚紧固螺栓 (8) 拧紧。

⑧  将电源连接线 (1) 连上电网。所设定的设备额定电压务必要与电源电压保持一致。

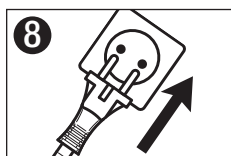
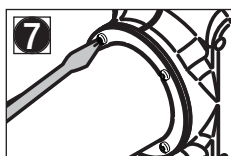
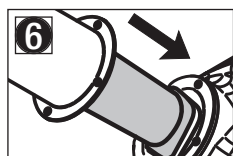
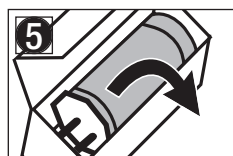
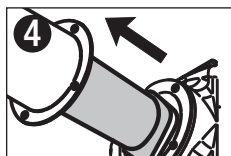
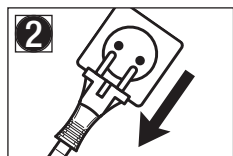
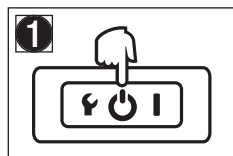

喷嘴/反射器更换



燃烧危险！不要触摸热的加热管元件和喷嘴。

更换喷嘴或反射器时应事先借助**总开关 (2)**  切断设备并使其冷却。设备自动关闭。

安装

- 只能由受过培训的专业人员安装设备。
- 安装尺寸参见第 3 页，质量/尺寸。



安装前借助**总开关 (2)**  切断设备并使其冷却。



电源连接线 (1) 应与电网断开。

- 必须确保连接线未接触到加热管元件且未阻断热空气射流。
- 必须用三枚 M5 螺栓将设备固定在**螺纹插入件 (9)** 上。
- 安装工作必须确保
 - 只吸入冷空气
 - 不会出现（热气）逆流
 - 一台设备的热空气射流不会喷到另一台设备。
- 空气含有灰尘时应使用 Leister 不锈钢过滤器（参见配件）并将其推到**进气法兰 (6)** 上。
- 积尘特别严重时（例如金属粉尘、导电粉尘或潮湿粉尘）必须使用专门的过滤器，以避免设备短路。
- 应防止设备出现机械振动或受到冲击。

运行

- 可以根据需要安装相应喷嘴或反射器。



必须注意确保热空气自由流出，否则热气逆流会导致设备损坏（火灾危险！）。



将**电源连接线 (1)** 连上电网。所设定的设备额定电压务必要与电源电压保持一致。

- 接通**总开关 (2)** 



热运行后借助**总开关 (2)**  切断设备并使其冷却。设备自动关闭。



电源连接线 (1) 应与电网断开。

- **注意：**用作安装设备时，必须在连接电源时使用合适的装置在**距离触点 3mm** 的地方**全极断开**电网。

操作 HOTWIND PREMIUM

- 温度可用红色电位计 (3) 进行设置。
- 气量可用蓝色电位计 (4) 进行设置。

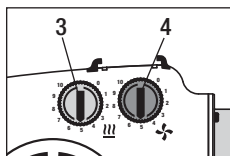

操作 HOTWIND SYSTEM

电位计

- 温度可用红色电位计 (3) 进行设置。
- 气量可用蓝色电位计 (4) 进行设置。

系统接口

- 温度和气量均可通过系统接口 (12) 进行控制。警报装置可通过设备的警报继电器输出端 (11) 连接。

温度电位计 (3) 和气量电位计 (4) 均无其他功能。

- 在电位计和接口之间的转换参见第 121 页“配置”。

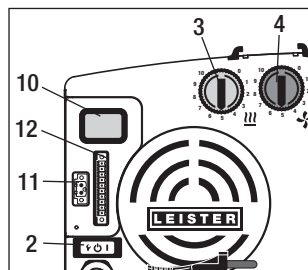

HOTWIND SYSTEM 显示

在设置菜单中进行相应设置（参见第 121 页）。

- 内部调节装置（闭环）
 - 温度可用红色电位计 (3) 进行设置。
 - 气量可用蓝色电位计 (4) 进行设置。
- 外部调节装置（闭环）
 - 温度可用外部调节器进行设置。
 - 气量可用外部调节器进行设置。
- 内部控制系统（开环）
 - 功率额定值可用红色温度电位计 (3) 进行设置。
 - 气量额定值可用蓝色气量电位计 (4) 进行设置。
- 外部控制系统（开环）
 - 功率额定值可用外部温度调节器进行设置。
 - 气量额定值可用外部气量调节器进行设置。

闭环

显示屏显示
温度实际值和额定值

实际值 — 395
额定值 — 450 °C

开环

显示屏显示
功率额定值（单位：%）
和温度实际值

实际值 — 490
额定值 % — 75P °C

配置和操作 HOTWIND SYSTEM

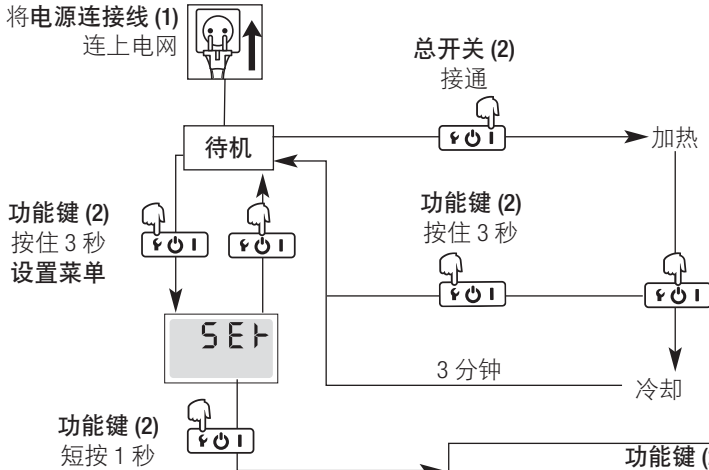

图例

显示	说明
Ri r (Air)	气量额定值
CEL (°C)	摄氏度
CLO (Closed Loop)	可调节的
CON (Connector)	接口
FRr (°F)	华氏度
HEr (Heater)	加热额定值
LOO (Loop)	调节装置
OPE (Open Loop)	可控的
POT (Pot)	电位计
SEt (Setup)	配置
Uni (Unit)	单位

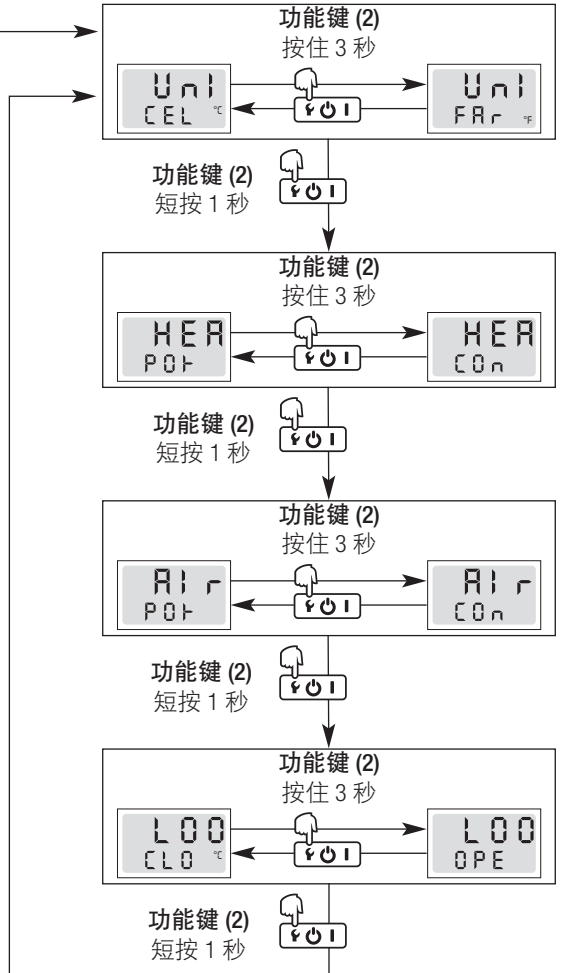

如果在设置菜单中未按住功能键 (2) 10 秒，则设备自动切换到待机

故障

- 如果设备出现功能性故障，那么在**显示屏 (10)** 上会显示一条有错误代码的信息。该代码更加清楚地描述了故障（参见表格）。
- 此故障可通过按下**功能键 (2)**  在三秒内复位 (Reset)。

显示屏	名称	故障原因	故障排除
Err 01	设备温度过高	环境温度高于给定值	降低环境温度
		进气温度高于给定值	降低进气温度
		进气口受阻	检查进气口
		不锈钢过滤器受阻	清洁不锈钢过滤器
		出气口受阻	检查出气口
		喷嘴安装错误	检查喷嘴
Err 02	加热元件温度过高	进气口受阻	检查进气口
		不锈钢过滤器受阻	清洁不锈钢过滤器
		出气口受阻	检查出气口
		喷嘴安装错误	更换喷嘴
Err 03	温度探头	温度探头连接错误	检查温度探头连接
		温度探头损坏	联系 Leister 服务站
Err 04 Err 05 Err 06 Err 07 Err 08	联系 Leister 服务站		

配件

- 只能使用 **Leister 原装配件** !
 - 把手套件 产品编号 141.723
 - 不锈钢过滤器 产品编号 107.248
- 其他配件请登录 www.leister.com 查看

培训

- Leister Technologies AG 及其授权的服务站可提供免费的焊接课程和培训。具体信息请登录 www.leister.com 进行了解。

保养

- **进气口 (6)** 脏污时请用刷子清洁
- 检查**电源连接线 (1)** 和插头是否有电气损坏或机械损坏

服务和维修

- 只能由授权的 **Leister 服务站** 进行维修。以实现根据电路图和备件清单使用原装备件在有效期内进行专业和可靠的**维修服务**。

质保

- 原则上，该设备的质保期限为购买之日（以发票或发货单上的日期为证）起一 (1) 年。如有损坏，将提供备件或维修服务。加热元件不在此质保范围之内。
- 在遵守相关法律条款的前提下，不包括其他权利和要求。
- 自然损耗、超负荷运转或操作不当所导致的设备损坏，均不在此质保范围之内。
- 经过买方改装或更改的设备不具有任何权利要求。

ホットwindをお買い上げいただきありがとうございます。

お客様はライスター社の高品質な材料で製作された最上の熱風機をお選びになりました。ホットwindは、いずれもスイス工場から出荷される前に厳重な品質管理を受けています。



使用を開始する前に取扱説明書をよくお読みになり、いつでも参照できる場所に保管してください。

熱風機

ホットwindプレミアム、ホットwindシステム

用途

熱風機ホットwindプレミアムおよびホットwindシステムは連続使用に適しています。特に機械、装置、機器への取り付けに適しており、あるいはハンドツールおよび卓上装置としてもご使用になられます。

本製品の最も重要な使用法は、例えば、乾燥および加熱、解冻、加速および溶解、滑らかにすることおよび光沢を付けること、活性化および弛緩、分離および併合、委縮、はんだ付け、溶接、取り外し、着火などです。



警告



熱風機を分解すると、電気が流れているコンポーネントと接続部が露出されるため、**生命の危険**があります。熱風機を分解する前に、電源プラグをコンセントから抜いてください。



誤った熱風機の取り扱い方をすると、特に燃焼する素材や爆発する可能性のあるガスの近くで使用すると、**火災および爆発の危険**があります。



火傷の危険 高温になっている加熱エレメントパイプとノズルに触れないでください。熱風機を冷却してください。熱風を人や動物に向けしないでください。



注意



機器に記されている**定格電圧**は電源電圧と一致してはなりません。EN 61000-3-11; $Z_{max} = 0.053 \Omega + j 0.033 \Omega$ 必要であれば、電力会社にご相談ください。



現場で熱風機を使用する場合、安全のために必ず**漏電遮断器**を使用してください。



熱風機は**必ず監視下**で使用してください。目に見えないところで、熱が可燃素材に達していることがあります。

熱風機は、必ず**熟練者**または熟練者の監視下で使用してください。決してお子様に使用させないでください。



熱風機が**湿ったり濡れたり**しないようにしてください。

組み込みの適合宣言書

(EG-機械規準 2006/42;付録 II Bに従って)

Leister Technologies AG, Galileo-Strasse 10, CH-6056 Kaegiswil/Schweiz は、以下の機器

名称： 熱風機
タイプ： ホットウィンド
仕様： プレミアムまたはシステム

が供給範囲内で適用されるEG機械基準(2006/42)に適合していることをここに証明いたします。

本機器は以下のEG基準の必須条件を遵守しています：

EG基準： 電磁互換性2004/108
低電圧基準2006/95

整合規格： EN 12100-1, EN 12100-2, EN 60204-1, EN 14121-1,
EN 55014-1, EN 55014-2, EN 61000-6-2,
EN 61000-3-2, EN 61000-3-3, EN 61000-3-11 (Z_{max})
EN 50366, EN 62233, EN 60335-2-45

更に、この機械の特別な技術情報が付録VII (B部分)に従って供され、また、市場監視当局に電子形式で正当化された要求であることを伝えるためのものです。

ドキュメンテーションの認可者名：パトリック・リーダー、コンプライアンスマネージャー

機械はEG-機械規準(2006/42)の決定に従って機械を取り付けるまで、不完全な機械の始動は禁止されています。

2011/11/28、ケーギスヴィル

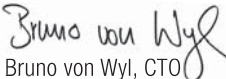
Bruno von Wyl, CTO

Beat Mettler, COO

廃棄



電動工具、付属品および梱包材は環境にやさしいリサイクルに出してください。EU諸国のみ電動工具を家庭ゴミとして出さないでください。廃電気・電子製品に関する欧州指令 2002/96、およびそれらの国内法への転換に基づき、使用できなくなった電動工具は個別に集め、環境に配慮した再利用をしなくてはなりません。

テクニカルデータ

電圧	V~	120	230	230	230	400
電力	W	2300	2300	3100	3680	5400
周波数	Hz	50/60				
排気口最高温度	°C	650	650	800	650	650
風量(20°C)	l/min.	200 – 900				
最大静圧	Pa	820	1050			
騒音	L _{pA} (dB)	< 70				
重量 電源ケーブルなし	kg	2.2	2.2	2.3	2.2	2.4
寸法	3 ページ (寸法)					
適合マーク	CE					
安全マーク						
保証タイプ						
保護等級 II	□					
本書に記載している内容は、予告なしに変更になる事があります。詳しい内容は別途お問い合わせください。						
電源電圧の切り替えはできません。						

	プレミアム	システム
加熱性能および風量をポテンシオメーターで無段階調節可能	●	●
内蔵電力変換装置	●	●
加熱エレメント/機器のオーバーヒート保護	●	●
警報出力		●
内蔵サーモスタット		●
温度/出力設定用 I/F コンインターフェース		●
風量設定用 I/F コンインターフェース		●
内蔵プローブ		●
規定/実測値表示ディスプレイ(°C または°F)		●

インターフェースのテクニカルデータ

プレミアム、システム リレー出力	最大電圧	AC 250V, DC 30V
	最大電流	AC 3A, DC 3A
	最大接触抵抗	100m Ohm bei DC 6V / 1A
	接点形式	SPST - NO
	絶縁 IEC/EN 60065	AC 2000V (50-60Hz) 1分

システム 信号入力 逆極性保護および零位補正 機能付き	絶縁 IEC/EN 60747-5-2	AC 1414Vピーク
	GND ISOに関する電圧入力 U_c	DC 0 - 10V (リップル < 0.05V、 5°C溶解の場合) (リップル < 0.1V、 1%溶解の場合)
	最大入力電圧	DC 12V
	公称入力インピーダンス	280kOhm
	電流入力 I_c (2芯導体技術)	DC 4~20mA (リップル < 0.1mA、 5°C溶解の場合) (リップル < 0.15mA、 1%溶解の場合)
	最大入力電流	DC 22mA
	公称入力インピーダンス	160 Ohm
電源 逆極性保護付き 信号入力の切断なし	GND ISOに関する動作電圧 U_s	DC 15~24V
	最大動作電圧	DC 25V
	消費電流	12mA (DC 24Vの場合)

開ループまたは閉ループ	出力制御機能	設定レベル OFF~100%; 1%刻み
	温度調節機能	規定値 50°C ~ 650°C 5°C刻み
規定値 ポテンシオメーターまたは インターフェース	内部ポテンシオメーター	規定値 OFF~100%または 50°C ~ 650°C
	外部インターフェース	規定値 OFF~100%または 50°C ~ 650°C

概要

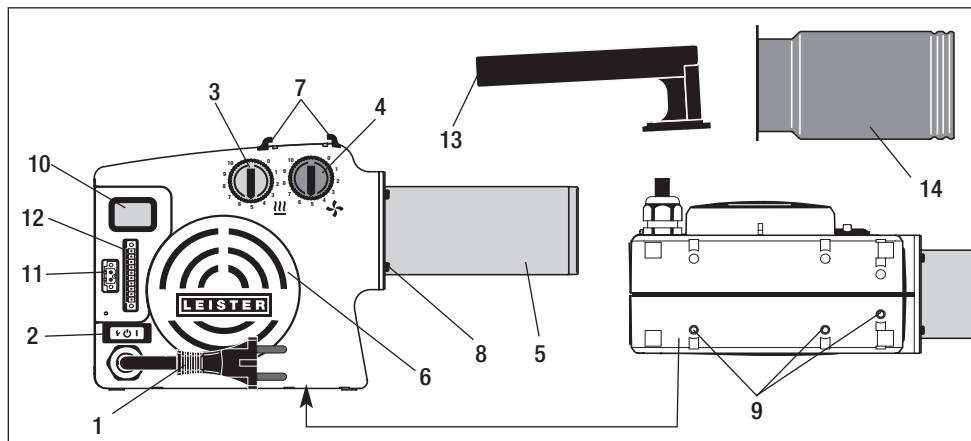

ホットwindプレミアムまたはホットwindシステム ホットwindシステム

- 1 電源ケーブル
- 2 ファンクションキー付きメインスイッチ
- 3 温度用ポテンシオメーター (赤)
- 4 風量用ポテンシオメーター (青)
- 5 加熱エレメントパイプ
- 6 ステンレス鋼フィルタ用吸気フランジ
- 7 取っ手用ホルダー
- 8 固定ねじ 4個
- 9 取り付け時の固定用ねじ込みインサートM5、3個

- 10 ディスプレイ
- 11 警報接点
- 12 インターフェース

ホットwindプレミアムまたはホットwindシステムのハンドツール

- 13 取っ手
- 14 保護パイプ

加熱エレメント/装置保護機能

- 加熱エレメントまたは本装置がオーバーヒートすると、吸気が温かすぎる、または熱が蓄積された)、加熱エレメントへの電源供給が遮断され、アラームリレーの作動端子が開きます。加熱エレメント保護または装置保護が作動した場合、ホットwindのリセットが必要です。リセットは、ファンクションキー(2)  を3秒間押すことによって行います。吸気を点検してください (取り付け参照)。

ポテンシオメーターの設定値

- この内部電子機器は最大排気温度を650℃に制限します。
- これは基準値であり周囲の条件や部品の許容範囲によって異なる場合があります。

ポテンシオメーター位置		0	1	2	3	4	5	6	7	8	9	10
加熱性能 %		OFF	10	20	30	40	50	60	70	80	90	100
風量 l/min		200	270	340	410	480	550	620	690	760	830	900
温度(3680W) (300 l/分の時) °C	周囲温度	90	150	215	275	340	400	465	525	590	650	

温度/風量のグラフ

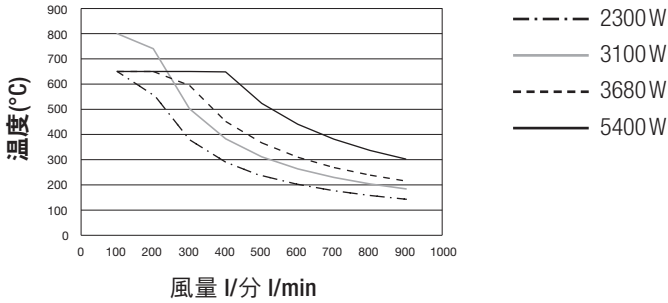

ホットウィンドシステム

インターフェース

11 警報接点

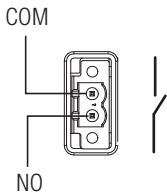

12 インターフェース

風量
15~24VDC
4~20mA -
4~20mA +
0~10V
アース端子



加熱性能
15~24VDC
4~20mA -
4~20mA +
0~10V
アース端子

電源には、電源/本線電源のプラグをソケットから抜くために適した装置をご使用ください（接点間の距離：3mm）。

警報接点：SPST-NO 250VAC/30VDC, 3A $\cos\phi = 1$

ホットウィンドシステム制御

入力0~10V

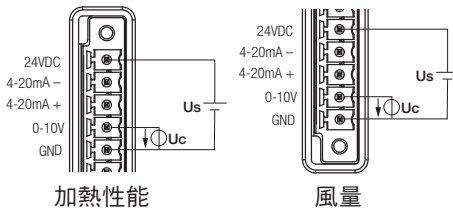

加熱性能

風量

性能f 制御電流)

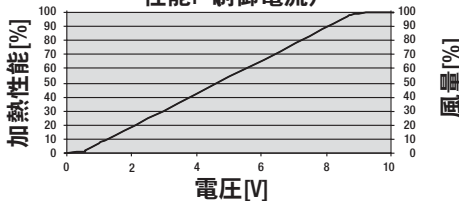

入力4~20mA

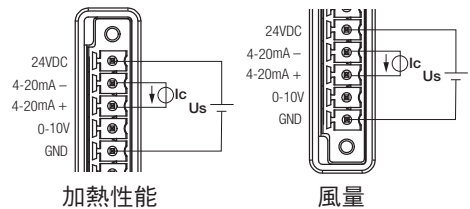

加熱性能

風量

性能f 制御電流)

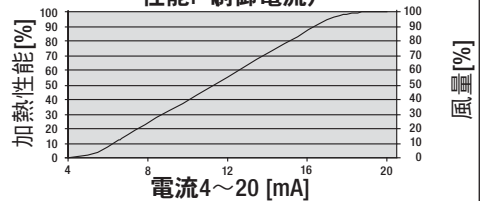

警告：0%時の風量は約 200 l/minです。

操作キット

- 操作キットの取り付けは、必ず専門の訓練を受けた者あるいはその監視の下で行ってください。
- **取っ手(13)**および**保護パイプ(14)**は本体に含まれていません (付属品参照)。

 操作キットを取り付ける前に、熱風機の**メインスイッチ(2)**  をオフにして冷却してください。熱風機は自動的にオフになります。

 **電源ケーブル(1)**を電源から抜きます。

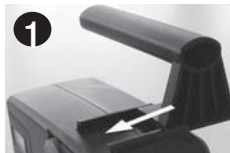

• 操作キットの取り付け

- ① **取っ手(13)**を**ホルダー(7)**に取り付けます。
- ② 4個の**固定ネジ(8)**を緩めます(取り外さないでください)。
- ③ **保護パイプ(14)**を**加熱エレメントパイプ(5)**に取り付け、**固定ネジ(8)**用の開口部に合わせます。
- ④ **保護パイプ(14)**をいっぱいまで締め込みます。
- ⑤ 4個の**固定ネジ(8)**を締め付けます。



加熱エレメントの交換

- 加熱エレメントの交換は、必ず専門の訓練を受けた者あるいはその監視の下で行ってください。

- ①  **メインスイッチ(2)**をオフにして、熱風機を冷却してください。熱風機は自動的にオフになります。
- ②  **電源ケーブル(1)**を電源から外します。
- ③ 4個の**固定ネジ(8)**を取り外します。 ④ **加熱エレメントパイプ(5)**と**加熱エレメント**を取り外します。
- ⑤ 加熱エレメントを梱包から取り出します。
- ⑥ 加熱エレメントを取り付け、**加熱エレメントパイプ(5)**を押し込みます。
- ⑦ **加熱エレメントパイプ(5)**を4個の**固定ネジ(8)**で固定します。
- ⑧  **電源ケーブル(1)**を電源に接続します。熱風機に記されている定格電圧は、電源電圧と一致していなくてはなりません。

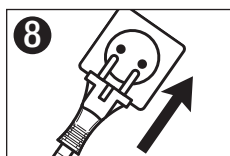
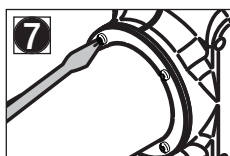
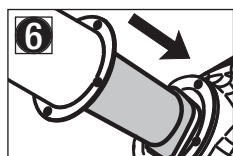
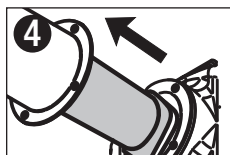
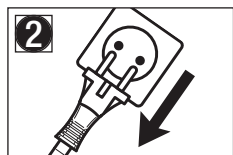
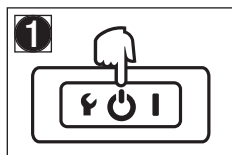

ノズル/リフレクターの交換



火傷の危険 高温になっている加熱エレメントパイプとノズルに触れないでください。

ノズルまたはリフレクターを交換する際は、事前に熱風機の**メインスイッチ(2)** をオフにして冷却してください。熱風機は自動的にオフになります。



取り付け

- 熱風機の取り付けは、必ず専門の訓練を受けた者が行ってください。
- 取り付け寸法については、3ページの寸法を参照してください。



取り付ける前に、熱風機の**メインスイッチ(2)** をオフにして冷却してください。熱風機は自動的にオフになります。



電源ケーブル(1)を電源から外します。

- 接続ケーブルが加熱エレメントパイプに触れず、熱風にさらされないようにしてください。
- M5ネジ3個を使用して、熱風機を**ねじ込み式インサート(9)**で固定してください。
- 取り付けは、以下を保証しなくてはなりません。
 - 冷風のみが供給される
 - 熱がこもらない
 - 他の機器の熱風があたらない
- 埃っぽい場所ではLeisterステンレス鋼フィルタ (付属品参照)を使用し、**吸気フランジ(6)**に取り付けます。
- 特に重大な埃(金属の粉塵、導電性の埃、湿気を含んだ埃など)のある場所では、特殊フィルタを使用して、本装置内でショートが発生するのを防止してください。
- 本装置を機械的な振動や揺れから保護してください。

作動

- 必要に応じて、適当なノズルまたはリフレクターを取り付けます。



熱が蓄積して本装置が損傷する可能性があるため(火災の危険)、熱風が外へ自由に流れることを確認してください。



電源ケーブル(1)を電源に接続します。熱風機に記されている定格電圧は、電源電圧と一致していません。

- **メインスイッチ(2)** をオンにします。



加熱後は、熱風機の**メインスイッチ(2)** をオフにして冷却してください。熱風機は自動的にオフになります。



電源ケーブル(1)を電源から外します。

- 警告 組み込み式装置としてご使用になる場合、電源には電源/本線電源のプラグソケットから抜くために適した装置をご使用ください。接点間の距離: 3mm)。

ホットウィンドプレミアムの操作

- 温度は赤色のポテンシヨメーター(3)で調節します。
- 風量は青色のポテンシヨメーター(4)で調節します。

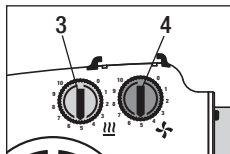

ホットウィンドシステムの操作

ポテンシヨメーター

- 温度は赤色のポテンシヨメーター(3)で調節します。
- 風量は青色のポテンシヨメーター(4)で調節します。

システムインターフェース

- 温度と風量は、システムインターフェース(12)で制御できます。警報は、本装置の警報用リレー出力(11)経由で接続できます。温度用ポテンシヨメーター(3)と風量用ポテンシヨメーター(4)は機能しなくなります。
- ポテンシヨメーターとインターフェースの切り替えについては、133ページの構成を参照してください。

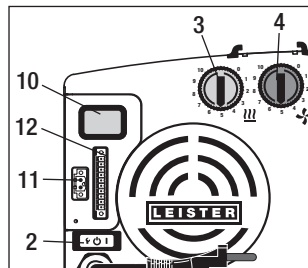

ホットウィンドシステムのディスプレイ(10)

設定メニューで適切に設定します (133ページ参照)。

- **内部制御 閉ループ**
 - 温度は赤色のポテンシヨメーター(3)で調節します。
 - 風量は青色のポテンシヨメーター(4)で調節します。
- **外部制御 閉ループ**
 - 温度は外部コントローラーで調節します。
 - 風量は外部コントローラーで調節します。

閉ループ

ディスプレイに温度の実測値と規定値が表示されます。

実測値 — 395
規定値 — 450 °C

- **内部制御 開ループ**
 - 出力の規定値は赤色の温度用ポテンシヨメーター(3)で調節します。
 - 風量の規定値は、青色の風量用ポテンシヨメーター(4)で調節します。
- **外部制御 開ループ**
 - 出力の規定値は温度用外部コントローラーで調節します。
 - 風量の規定値は風量用外部コントローラーで調節します。

開ループ

ディスプレイに出力の規定値(%)と温度の実測値が表示されます

実測値 — 490
規定値(%) — 75P °C

ホットwindシステムの構成および操作

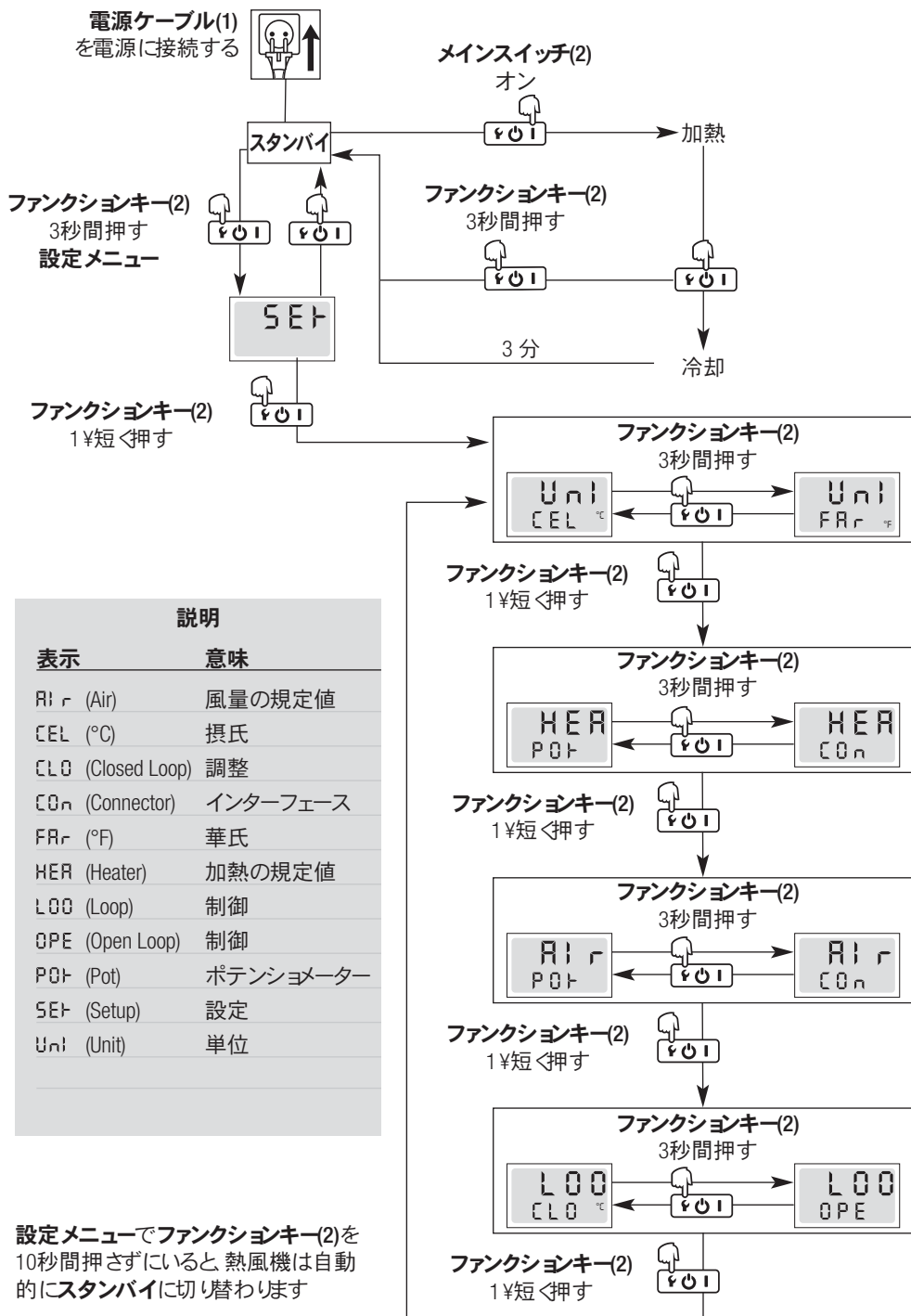

説明

表示	意味
Air (Air)	風量の規定値
CEL (°C)	摂氏
CLO (Closed Loop)	調整
CON (Connector)	インターフェース
FAR (°F)	華氏
HEA (Heater)	加熱の規定値
LOOP (Loop)	制御
OPE (Open Loop)	制御
POT (Pot)	ポテンシオメーター
SET (Setup)	設定
Unit (Unit)	単位

設定メニューでファンクションキー(2)を10秒間押さずにいると、熱風機は自動的にスタンバイに切り替わります

エラー

- 熱風機に故障が発生すると、**ディスプレイ(10)**にメッセージがエラーコードと共に表示されます。このコードは故障を転写したものです(表参照)。
- エラーは、**ファンクションキー(2)**  を3秒間押すとリセットされます。



表示	名称	エラー原因	エラー解消
Err 01	機器の温度が高すぎる	周囲温度が規定より高い	周囲温度を下げる
		給気温度が規定より高い	給気温度を下げる
		吸気口が塞がれている	吸気口を点検する
		ステンレス鋼フィルタが詰まっている	ステンレス鋼フィルタを清掃する
		排気口が塞がれている	排気口を点検する
		間違ったノズルが取り付けられている	ノズルを確認する
Err 02	加熱エレメントの温度が高すぎる	吸気口が塞がれている	吸気口を点検する
		ステンレス鋼フィルタが詰まっている	ステンレス鋼フィルタを清掃する
		排気口が塞がれている	排気口を点検する
		間違ったノズルが取り付けられている	ノズルを交換する
Err 03	温度プローブ	温度プローブの接続不良	温度プローブの接続を点検する
		温度プローブの故障	Leisterサービスステーションにお問い合わせください
Err 04 Err 05 Err 06 Err 07 Err 08	Leisterサービスステーションにお問い合わせください		

付属品

- **Leister製の付属品のみ使用してください。**
操作キット 製品番号 141.723
ステンレス鋼フィルタ 製品番号 107.248
- その他の付属品については、www.leister.com を参照してください。

トレーニング

- Leister Technologies AG とその認定サービスセンターは、無料の溶接コースとトレーニングを提供しています。詳細については、www.leister.com を参照してください。

メンテナンス

- 吸気口(6)が汚れた場合は、ブラシで清掃してください。
- **主要電源(1)**とプラグは電気的および機械的な損傷がないことを点検してください。

サービスと修理

- 修理は、必ず指定の **Leister サービスステーション**で実施してください。これらのサービスステーションは、妥当な期限内に配線図および交換部品リストに従って純正交換部品を使用した、専門的で信頼できる**修理サービス**を保証します。

保証

- 本製品には、お買い上げになられた日から1年間の原則的な保証があります(請求書または納品書による証明が必要です)。損傷がある場合は、交換または修理によって補償いたします。ヒーターエレメントは、この保証の対象には含まれません。
- その他の苦情は、法規定を前提として除外されます。
- 自然消耗、過負荷、不適切な取り扱いによる損傷は、保証の対象とはなりません。
- お客様によって改造または変更された製品は保証の対象とはなりません。



Your authorised Service Centre is:

A large, empty rectangular box with a thin black border, intended for the user to write the name and address of their authorized service center.

Leister Technologies AG
Galileo-Strasse 10
CH-6056 Kaegiswil/Switzerland

Tel. +41 41 662 74 74

Fax +41 41 662 74 16

www.leister.com

sales@leister.com