

# VULCAN E: The muscle man.

The muscle man among the hot-air blowers leaves no doubts about its performance. It is compactly built and easy to integrated in industrial processes.

Hot-air blower

## VULCAN E



| Technical data<br>VULCAN E  |            | For KSR<br>DIGITAL |
|---|------------|--------------------|
| Heating power steplessly adjustable with potentiometer  | •          |                    |
| Manual air slider   | •          |                    |
| Heating element tube with protective tube   | •          | •                  |
| Integrated device and heating element protection  | •          | •                  |
| Remote control interface for<br>KSR DIGITAL temperature regulator<br>or external PLC control 0 – 12 V<br>incl. 5 m cable and plug |            | •                  |
| Max. air outlet temperature °C  | 650        | 650                |
| Max. air flow l/min. (20 °C) 3 × 230 V~   | 850 / 1500 | 850 / 1500         |
| Max. air flow l/min. (20 °C) 3 × 400 – 440 V~   | 950 / 1700 | 950 / 1700         |
| Weight kg   | 9.3        | 9.3                |
| Mark of conformity  | CE         | CE                 |
| Approval mark   | Ⓢ          |                    |
| Certification scheme  | CCA        |                    |
| Protection classe II  | Ⓢ          | Ⓢ                  |

Installation dimensions in mm

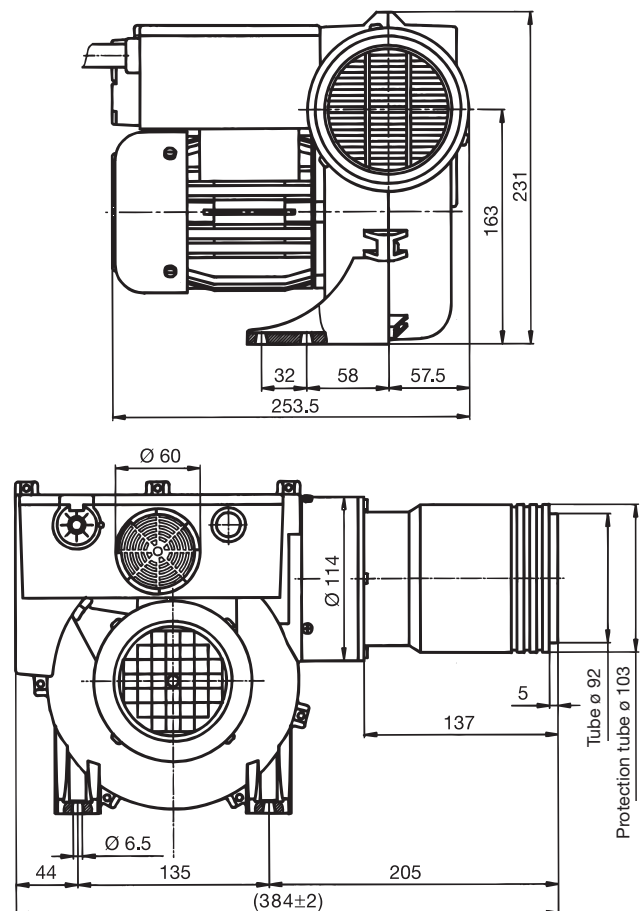

|                                  |         |               |               |         |
|----------------------------------|---------|---------------|---------------|---------|
| Voltage V ~                      | 3 × 230 | 3 × 400 – 440 | 3 × 400 – 440 | 3 × 500 |
| Power consumption kW             | 10      | 5.6 – 7.6     | 11 – 13.5     | 10      |
| Frequency Hz                     | 50 / 60 | 50 / 60       | 50 / 60       | 60      |
| Order no.                        | 103.577 | 110.633       | 103.578       | 112.150 |
| <b>For KSR DIGITAL</b> Order no. |         |               | 115.599       |         |

Additional versions on request



## Temperature controller

### KSR DIGITAL



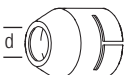
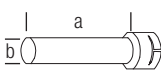
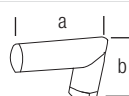
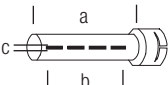
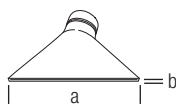
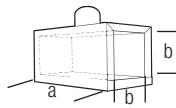
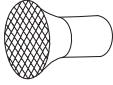

| Technical data  | KSR DIGITAL  |
|---|--|
| Suitable for LEISTER air heaters                              | VULCAN E   |
| Regulation type   | PID  |
| Ready to use with preconfigured parameter set                 | •  |
| Configuration with PC and programming cable (see Accessories) |  |
| Accuracy  | Accuracy better than 0.2% of scale value at 25 °C  |
| Switchover °C °F  | Configurable via keypad  |
| Temperature sensor / input                                    | Type K / socket  |
| Alarm output  | 2 alarms independently configurable<br>Output at 2 floating relay contacts<br>2mm receptacle                         |
| Connection to air heater                                      | Socket, compatible with KSR models   |
| Voltage   | 100 – 240 VAC, max. 8 VA   |
| Mains connection lead   | 2 m, with Euro plug  |
| Mechanics   | Regulator built into housing, ready to operate, can also be integrated into the front panel, with cut-out 67 × 67 mm |
| Size L × W × H  | 175 × 72 × 72 mm   |
| Weight kg   | 0.5  |
| Mark of conformity  | CE   |
| Protection classe II  | □  |
| Order no.   | For VULCAN E, 400 – 440 V / 11 – 13.5 kW °C 110.364  |

**Accessories VULCAN E**  
(Ø 92 mm)

|  |   |  |
|--|---|--|
| 125.318  |    | FI Flange connector, push-fit<br>a = 120 mm  |
| 107.244  |    | Round nozzle, push-fit<br>d = 50 mm  |
| 107.273  |    | Extension nozzle, push-fit (a × b)<br>500 × 60 mm  |
| 107.269  |    | Angled nozzle, push-fit (a × b)<br>Schenkellänge 175 × 175 mm  |
| 106.031<br>106.035<br>107.268<br>106.036<br>106.033<br>106.038                       |  | Tubular nozzle, push-fit (a × b × c)<br>1000 × 800 × 2 mm<br>1185 × 900 × 1.6 mm<br>1288 × 1000 × 1.5 mm<br>1535 × 1250 × 1.2 mm<br>1550 × 1350 × 1.1 mm<br>2225 × 2000 × 0.8 mm |
| 107.274<br>106.028<br>107.272<br>106.018<br>106.024<br>107.267<br>106.023<br>106.026 |  | Wide slot nozzle, push-fit (a × b)<br>130 × 17 mm<br>220 × 12 mm<br>300 × 12 mm<br>400 × 10 mm<br>500 × 7 mm<br>500 × 15 mm<br>600 × 4 mm<br>600 × 9 mm                          |
| 107.341  |  | Shell reflector, push-fit (a × b)<br>370 × 160 mm  |
| 107.276  |  | Sieve reflector, push-fit<br>Ø 260 mm  |
| 107.277  |  | Stainless steel filter, push-fit<br>on air intake  |

**Accessories KSR DIGITAL**

|                               |  |  |
|-------------------------------|--|--|
| 106.956                       |  | Thermocouple with plug,<br>1 m cable<br><br><b>KSR DIGITAL</b>   |
| 106.958<br>106.960<br>106.962 |  | Thermocouple extension<br>cable with plug and connection<br>2 m<br>4 m<br>10 m<br><br><b>KSR DIGITAL</b> |
| 111.331                       |  | Controller/extension cable<br>5 m<br><br><b>&gt; KSR DIGITAL</b>   |

**Special nozzles on request**

If using non-Leister blowers, compressors and accessories no guarantee can be given by us