

**LEISTER**

PROCESS HEAT

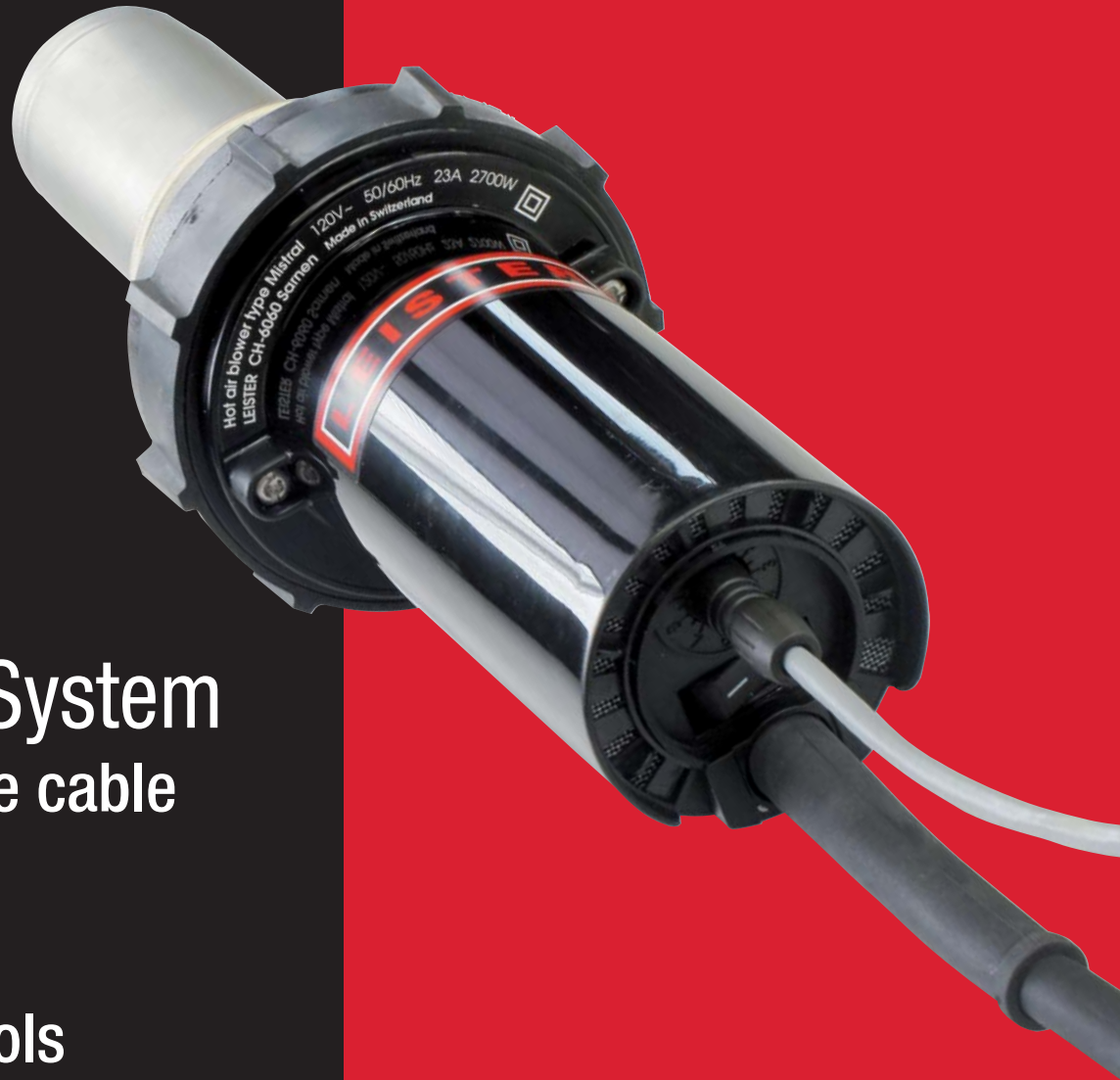

## MISTRAL System with interface cable

Simple controls  
at any time.

## MISTRAL System

The demand for controllable and adjustable industrial hot air systems is constantly growing. That is why we have equipped our MISTRAL System with control and adjustment technology. With the MISTRAL System the heating performance can precisely be controlled via the normal industry standard control signals from 4 – 20 [mA] or 0 – 10 [V]. Using these precise temperature controls, processes which rely on accuracy can be carried out with dependable reliability. With its brushless motor the MISTRAL System is intended for long-term, continuous use in heavy industrial environments.

## Applications

Thanks to its integrated fans, the MISTRAL System from Leister is suitable for many different hot air applications, including:

- Pre-heating and warming up
- Removing bacteria, sterilising
- Smoothing and polishing
- Activating
- Pasteurising
- Accelerating
- Baking
- Drying

## Closed loop controlled MISTRAL System

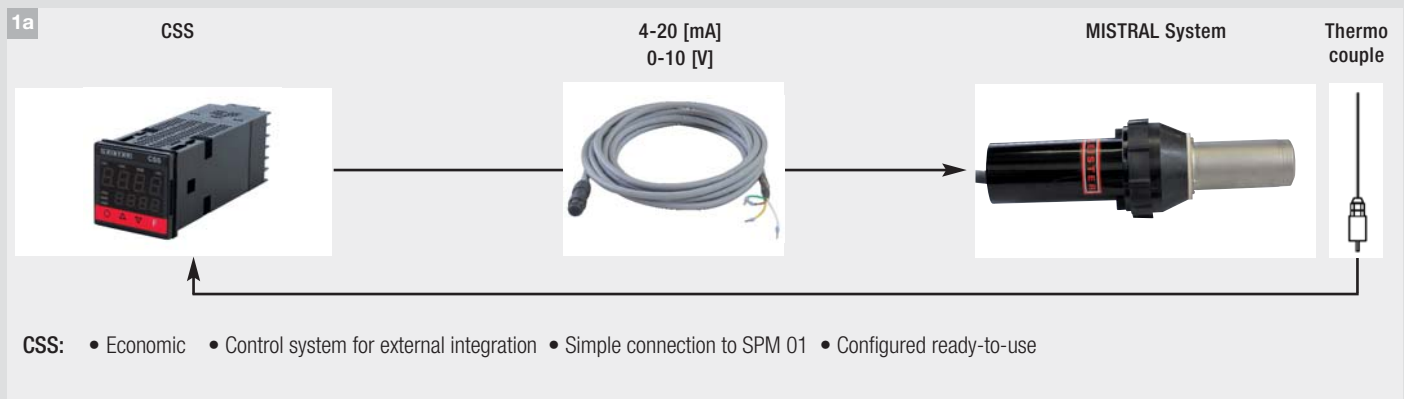

## Open loop controlled MISTRAL System

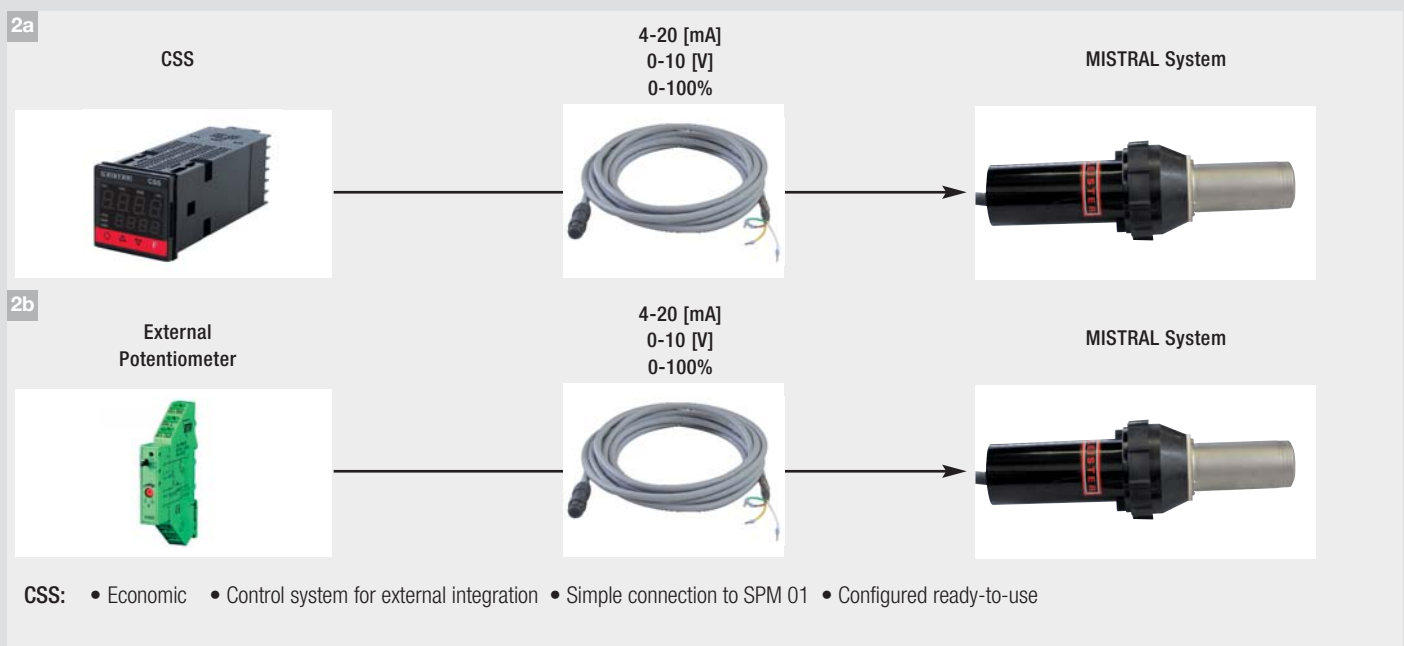



Control with 4-pin plug

## Features

- Maintenance free, brushless motor for continuous operation
- Compact size
- Adaptable integration
- Flexible controls 4 – 20 [mA] 0 – 10 [V]
- Max. temperature 650°C
- Large choice of accessories

### Technical Data

Maintenance free, brushless motor for continuous operation	•
Mains plug	•
Interface cable	•
Air filter	•
Manual airflow control	•
Built-in protection for equipment and heating element	•
Max. Air output temperature	°C 650
Max. air volume	l/min. 350
Static pressure	kPa 2.48
Noise emission level	LpA (dB) 65
Weight with 3 m cable	kg 1.5
Conformity mark	CE
Safety standard	Ⓢ
Type of certification	CCA
Protection class	II





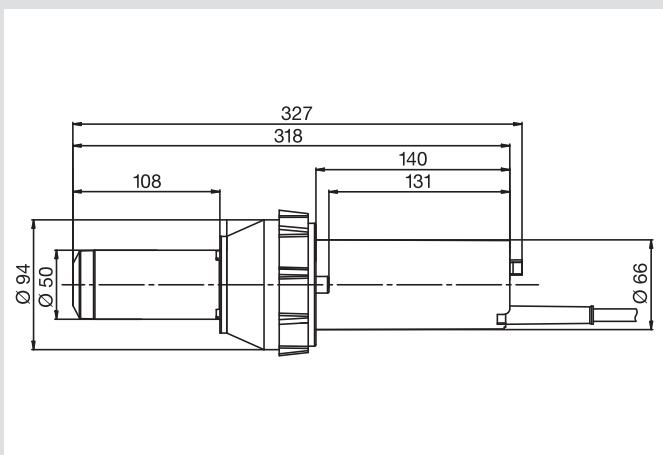

### Order no.y:

140.254	Mistral System 230V / 2300W with European plug	max. 450 °C
140.253	Mistral System 230V / 3400W with European plug	max. 650 °C
140.255	Mistral System 120V / 2700W no plug	max. 450 °C
140.256	Mistral System 230V / 2300W with Swiss plug	max. 450 °C

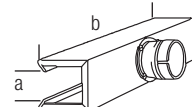
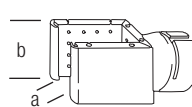
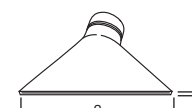
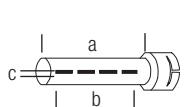
## Dimensions in [mm]



## Accessories MISTRAL System

<b>107.340</b>		Curved reflector, push-fit (a × b) 45 × 250 mm
<b>107.327</b> <b>107.333</b>		Sieve reflector, push-fit (a × b) 85 × 85 mm 130 × 150 mm
<b>106.057</b> <b>106.060</b> <b>107.270</b> <b>106.061</b>		Wide-slit nozzle, push-fit (a × b) 100 × 4 mm 150 × 6 mm 150 × 12 mm 300 × 6 mm
<b>105.950</b> <b>107.257</b> <b>105.955</b> <b>105.952</b> <b>105.956</b>		Tubular nozzle, push-fit (a × b × c) 460 × 300 × 2 mm 590 × 420 × 1.7 mm 836 × 660 × 1 mm 900 × 800 × 0.9 mm 1000 × 820 × 0.9 mm
<b>133.516</b>		Temperature probe mounting
<b>133.067</b>		Mounting
<b>123.039</b>		CSS – Temperature controller
<b>106.956</b>		Temperature probe with plug, 1 m cable
<b>106.958</b> <b>106.960</b> <b>106.962</b>		Temperature probe extension cable with plug 2 m 4 m 10 m
<b>140.252</b>		Interface cable ICI 01A 3 m

**Headquarters:**

Leister Process Technologies  
 Galileo-Strasse 10  
 CH-6056 Kaegiswil/Switzerland  
 phone: +41 41 662 74 74  
 fax: +41 41 662 74 16  
 leister@leister.com

Leister Technologies LLC  
 1253 Hamilton Parkway  
 Itasca, IL 60143/USA  
 phone: +1 630 760 1000  
 fax: +1 630 760 1001  
 sales@leisterusa.com

Leister Technologies Ltd.  
 Building A, 1588 Zhuanxing Road  
 Shanghai 201 108 PRC  
 phone: +86 21 6442 2398  
 fax: +86 21 6442 2338  
 leister@leister.cn

Leister Technologies KK  
 Shinyokohama Bousei Bldg 1F  
 3-12-20, Shinyokohama, Kohoku-ku,  
 Yokohama 222-0033  
 phone: +81 (45) 477 3637  
 fax: +81 (45) 477 3638  
 sales-japan@leister.com

**Our close worldwide network of more than 120 Sales and Service Centers in more than 90 countries.**

**Europe:**

Austria  
 Belgium  
 Bulgaria  
 Croatia  
 Cyprus  
 Czech Republic

Estonia  
 Denmark  
 Finland  
 France  
 Germany  
 Great Britain  
 Greece

Hungary  
 Ireland  
 Iceland  
 Italy  
 Latvia  
 Lithuania  
 Netherlands

Normay  
 Poland  
 Portugal  
 Romania  
 Russia  
 Serbia  
 Slovakia

Slovenia  
 Spain  
 Sweden  
 Switzerland  
 Turkey  
 Ukraine



Distributor Address: