

# HOTWIND PREMIUM / SYSTEM: The versatile hot air blower.

The new HOTWIND PREMIUM is the successor to the hugely popular HOTWIND S. Its brushless motor ensures that this hot air blower has a long service life. The maximum air volume can now be set infinitely up to 900 l/min via the potentiometer.

The wide range of applications makes the new HOTWIND SYSTEM truly impressive: be it as a unit with integrated control or as a unit for integration in a closed loop control circuit using a system interface.

## Hot air blower

## HOTWIND PREMIUM / SYSTEM



HOTWIND PREMIUM

### Technical data HOTWIND PREMIUM / HOTWIND SYSTEM

Voltage	V~	120	230	230	230	230	230	400
Power consumption	W	2300	2300	2300	3100	3680	3680	5400
Frequency	Hz	50 / 60						
Max. air outlet temperature	°C	650	650	650	800	650	650	650
Max. air flow (20 °C)	l/min	200 – 900						
Static pressure	kPa	0.8	1.0					
Noise emission	dB(A)	< 70						
Weight without cable	kg	2.2		2.3		2.2		2.4
Dimensions		see below left						
Mark of conformity		CE						
Protection class II		□						
Without connecting plug		•		•			•	•
Connecting plug (Euro)			•		•	•		
Order no. HOTWIND PREMIUM		140.095	142.612	142.643	142.608	142.609	140.098	142.644
Order no. HOTWIND SYSTEM		142.636	142.646	140.096		142.645	142.640	142.641

Subject to change without notice  
Connection voltage non-switchable

Additional versions on request

### Installation dimensions in mm

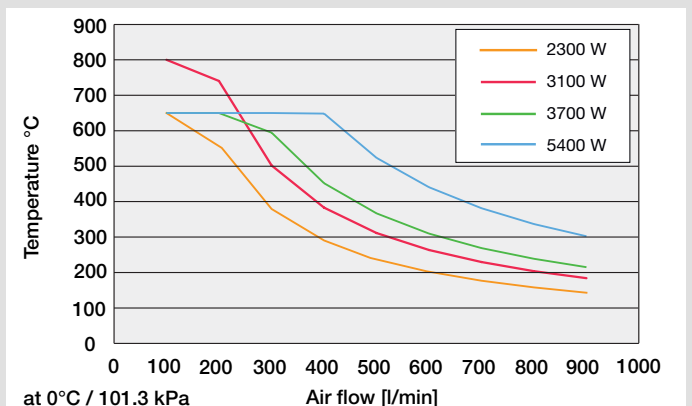
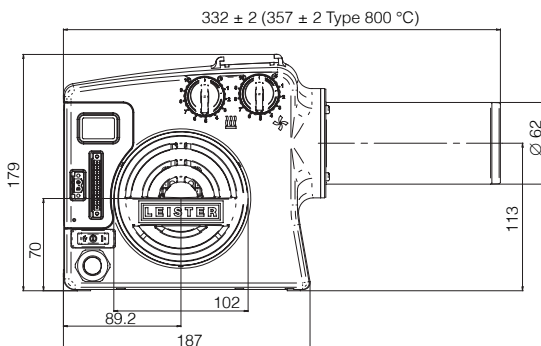
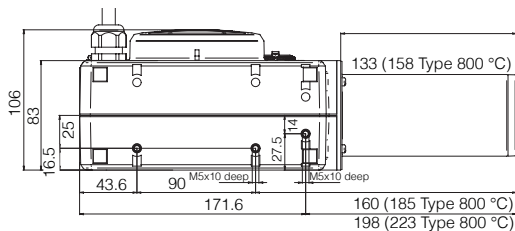





→ Accessories page 17

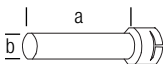
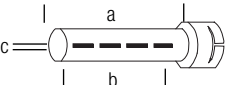
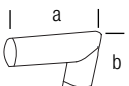
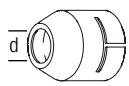
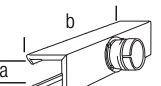
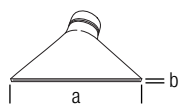
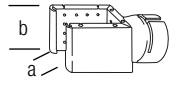
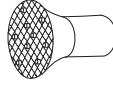

HOTWIND hot air blowers shrink the film on bulky packages.

## Accessories HOTWIND PREMIUM / SYSTEM (Ø 62 mm)

125.317		Flange connector, push-fit a = 90 mm		106.956 Temperature probe with plug and 1 m cable
107.247		Extension nozzle, push-fit (a × b) 200 × 45 mm		
105.917 105.907 105.919 107.253 114.136 105.906		Tubular nozzle, push-fit (a × b × c) 303 × 153 × 6 mm 354 × 204 × 4.5 mm 456 × 306 × 3 mm 700 × 550 × 1.7 mm 795 × 655 × 1.5 mm 1100 × 1000 × 4 mm		
107.265		Angled nozzle, push-fit (a × b) shank length 120 × 112 mm		
107.245		Round nozzle, push-fit d = 40 mm		
107.342 106.174 106.175		Shell reflector, push-fit (a × b) 50 × 400 mm 65 × 400 mm 80 × 400 mm		
107.260 107.259 105.977 107.263 107.262 105.992 105.991		Wide slot nozzle, push-fit (a × b) 85 × 15 mm 150 × 12 mm 200 × 9 mm 250 × 12 mm, with sieve insert 300 × 4 mm 400 × 4 mm 500 × 4 mm		
106.143 107.329 107.336		Sieve reflector, push-fit (a × b) 45 × 75 mm 70 × 75 mm 110 × 152 mm		
107.335		Sieve reflector, push-fit Ø 150 mm		
107.248		Stainless steel filter, push-fit on air intake		
141.723		Hand tool kit (handle and protective tube)		