

# Leister WELDPLAST S2 Hand extruder



Please read operating instructions carefully before use and keep for further reference.

## APPLICATION

**Welding of thermoplastic polymers of PE and PP (other materials on request) in the areas**

- container engineering
  - plastic fabrication
  - pipeline construction
  - Seam form
- Welding extruder corresponds with DVS 2207-4

**DVS:** *Deutscher Verband für Schweißtechnik  
(German Association for Welding Technology)*

**BAM:** *Federal Institute for Materials Research and Testing, Berlin*





## WARNING



### Danger to life!

Danger to life when opening up the tool, as live components and connections are exposed. Before opening the tool, unplug from the mains supply. Electrically conducting material (e.g. PE-EL) must not be welded.



**Fire and explosion hazard** with incorrect use of the hand extruder (e.g. overheating of the material), especially near combustible materials and explosive gases.



**Danger of getting burned!** Do not touch exposed metal parts and escaping plastized material. Do not point the hot air flow and escaping plastized material in the direction of people or animals.



Connect the tool to a **mains socket with protective earth**. Every interruption of the protective earth inside or outside of the tool is dangerous!

**Only use extension cables with protective earth!**



## CAUTION



The **voltage rating** stated on the name plate of the tool must correspond to the mains voltage.

In case of a power outage, the main switch and the drive must be switched off (loosen lock).



For personal protection on building sites we **strongly recommend** the tool to be connected to a RCCB (Residual Current Circuit Breaker).



The tool must be operated **under supervision**.

Heat can ignite flammable materials which are not in view. The machine may only be used by **qualified specialists** or under their supervision. Children are not authorized to use this machine.



**Protect** tool from **dampness and wet**.

## TECHNICAL DATA

Voltage	V~	230
power consumption	W	3000
Frequency	Hz	50/60
Air flow (20°C)	l/min	ca. 270
Air temperature	°C	max. 350
Plastifizer temperature	°C	max. 2600
Welding output	Ø 3 kg/h	PE 0.6–1.3 PP 0.5–1.2 (Average values at 50 Hz)
Welding output	Ø 4 kg/h	PE 1.0–2.3 PP 0.9–2.0 (Average values at 50 Hz)
Welding rod	mm	Ø 3 / Ø 4
Size L × B × H	mm	450 × 98 × 260 (without welding shoe)
Weight	kg	5.8 (without cable to mains)
Marking of conformity		CE
Approval mark		Ⓢ
Certification scheme		CCA
Protection class I		Ⓛ

Description of tool

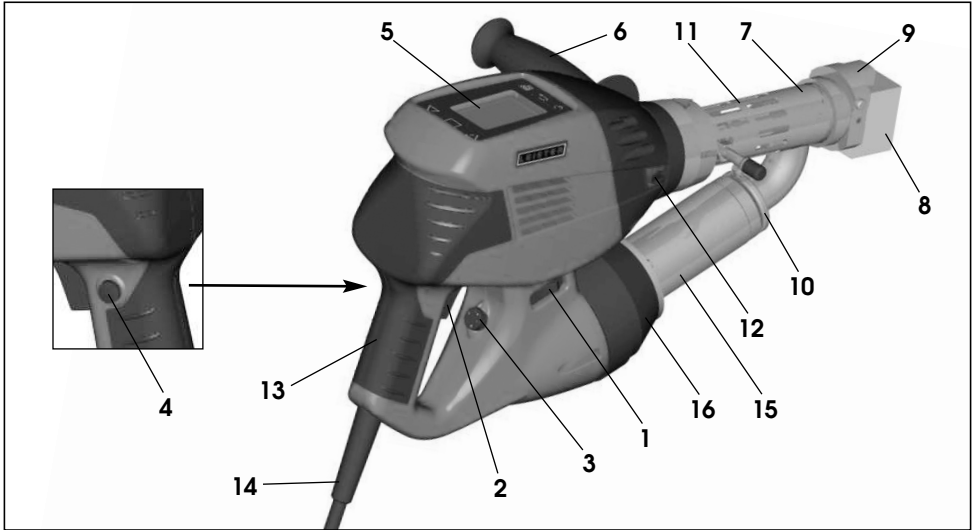

- |                        |                                |
|------------------------|--------------------------------|
| 1 Main switch          | 9 Pre-heating nozzle           |
| 2 On/off switch drive  | 10 Tube clamp                  |
| 3 Potentiometer        | 11 Protective tube             |
| 4 Drive locking device | 12 Welding rod opening         |
| 5 Display              | 13 Tool handle                 |
| 6 Handle               | 14 Mains cable                 |
| 7 Jacket heating       | 15 Heating element             |
| 8 Welding shoe         | 16 Hot air blower (brush-free) |

Bedieneinheit

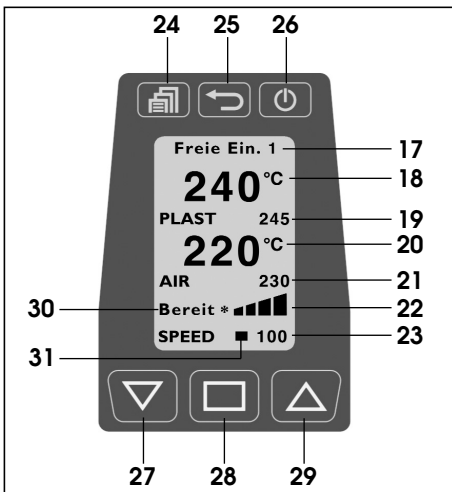

- |                             |
|-----------------------------|
| 17 Welding program          |
| 18 Actual value plast       |
| 19 Set value plast          |
| 20 Actual value air         |
| 21 Set value air            |
| 22 Bar display for drive    |
| 23 Welding output display   |
| 24 Menu key                 |
| 25 Back key                 |
| 26 Stand-by/Enter key       |
| 27 Down key                 |
| 28 Select key               |
| 29 Up key                   |
| 30 Status display for drive |
| 31 Cursor                   |

### Working environment / safety



The hand extruder must not be used in inflammable environments or where explosion hazards exist. Ensure stable positioning during operation. The connection cable and the welding rod must remain unimpeded and must not hinder the user or others during operation.



Rest the hand extruder on a fireproof surface! Hot metal parts and the hot-air jet must have sufficient clearance from the surface and walls.

### Handle Adjustment

1. Loosen the clamping by turning the **handle (6)** in counterclockwise direction.
2. Adjust **handle (6)** to the requested working position.
3. Tighten handle clamping again by turning **handle (6)** in clockwise direction.

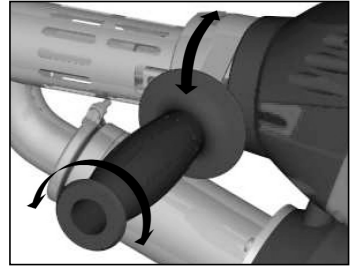

### Workplace

For starting operation of and placing down the hand extruder, Leister offers a **universal device stand**.



When interrupting the welding, the drive is to be switched off with the **drive on/off switch (2)**.

With the handle properly adjusted and firmly tightened, place down the manual extruder on a stable and fire-proof surface as shown in the figure.

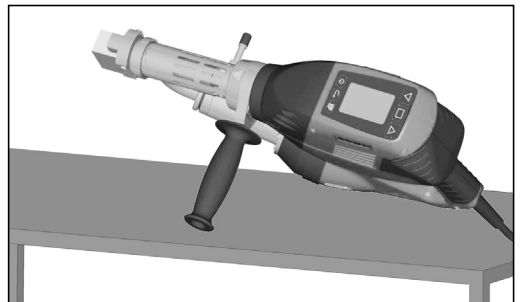

### Power supply

When using an extension cable, take care to ensure the minimal cable cross-section:

Length (m)	Minimum cross-section (at ~230V) (mm <sup>2</sup> )
Up to 19	2.5
20 – 50	4.0

Extension cables must be approved for the working environment (e.g. outdoors) and labelled accordingly.

If a generator is used to supply electricity, the rated power of the generator must be 2x the rated power of the hand extruder.

### Starting procedure

Temperature monitoring prevents the hand extruder starting up in a cold state.

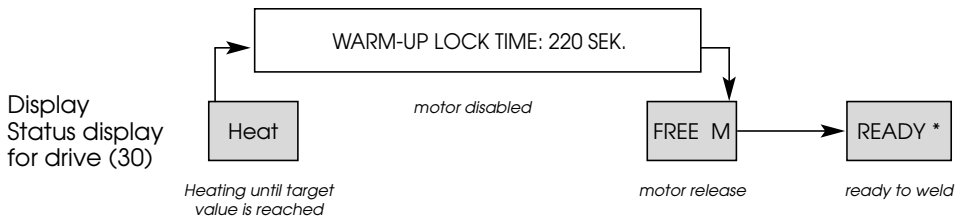

After switching on the **main switch (1)**, the device directly heats up to the last adjusted set values. When the set values are reached, a counter in the status indication counts back from 220 seconds to zero. Once this starting procedure has elapsed, the device is ready for welding (status: Ready\*). The operating temperature of the manual extruder is reached after approx. 5 minutes.

After a short-term mains break, the starting procedure is not repeated.

### Software and menu navigation

The Weldplast S2 manual extruder comes with comfortable and convenient operator software, allowing for easy operation.

### Key functions

The keys respond with gentle keystrokes.

#### • Operating window



#### Operating window functions

	Menu selection
	Set contrast
	Heating on/off
	Change cursor position
	Selected parameter (+)
	Selected parameter (-)

#### • Menu selection

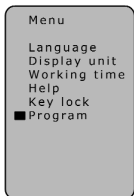

#### Menu selection functions

	Menu selection / return to operating window
	Back to multifunctional display (Changed entry is not stored!)
	Select and return to operating window
	Select
	Cursor up / selected parameter +
	Cursor down / selected parameter -

### Preparation for welding

#### Start window

After switching on the extruder, the name of the tool and the current software version are displayed for 3 sec.



#### Operating window

The operating window shows the parameters currently set.

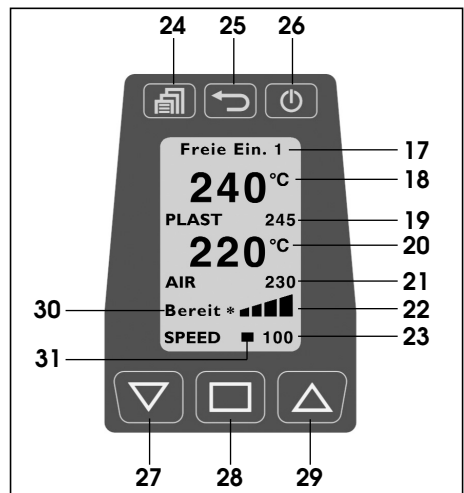

### Setting parameters in the operating window

The **cursor (31)** shows which parameters can be set. After switching on, the cursor is on the «**SPEED**» position.

In the operating window, the following parameters can be selected with the **Select key (28)** and changed in their values with the **Up key (29)** and **Down key (27)**.

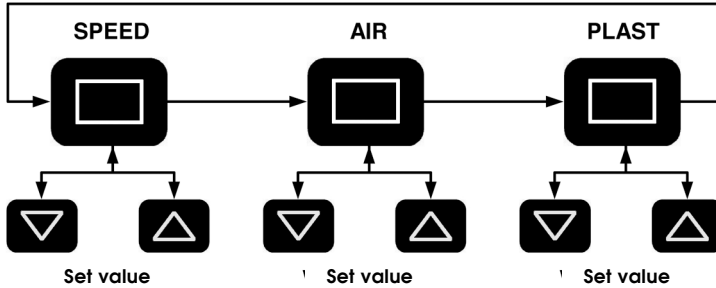

### Adjusting the Output Capacity

Due to the seam form, the output capacity and the pre-heating period can be matched to each other.

- Pre-adjustment at the display
  - By pressing the **select key (28)**, set the cursor to the «**SPEED**» position.
  - Specify the maximum output value (30 to 100) via the **up key (29)** or **down key (27)** (Indication via the **bar display for drive (22)**).
- Fine-adjustment during the welding procedure
  - By turning the **potentiometer (3)**, the output capacity of the maximal set output value (e.g. 85) can be reduced to the minimum.

3

**Example**

Ready \* **SPEED** ■ 85

Ready \* **SPEED** ■ 100

Ready \* **SPEED** ■ 30

22

The output capacity depends on the thickness of the welding wire. If the welding output is too high with the output display “30” and the potentiometer is set to “minimum”, the next smallest welding rod thickness must be selected.

**Setting the PLAST and AIR temperatures**

- Set the cursor to the «PLAST» or «AIR» position by pressing the **Select key (28)**.
- Set the temperature value with the **Up (29)** or **Down (27)** keys.

**Monitoring the welding parameters**

The set and actual values of the AIR and PLAST temperatures are continuously monitored. If the actual value deviates from the respective set value (value outside the tolerance band), this is indicated on the **status display (30)** with a status change. If necessary, the drive motor is temporarily disabled until the welding parameters are once again within the prescribed tolerance band. The possible status displays and the tolerance bands may be seen in the following graph and table.

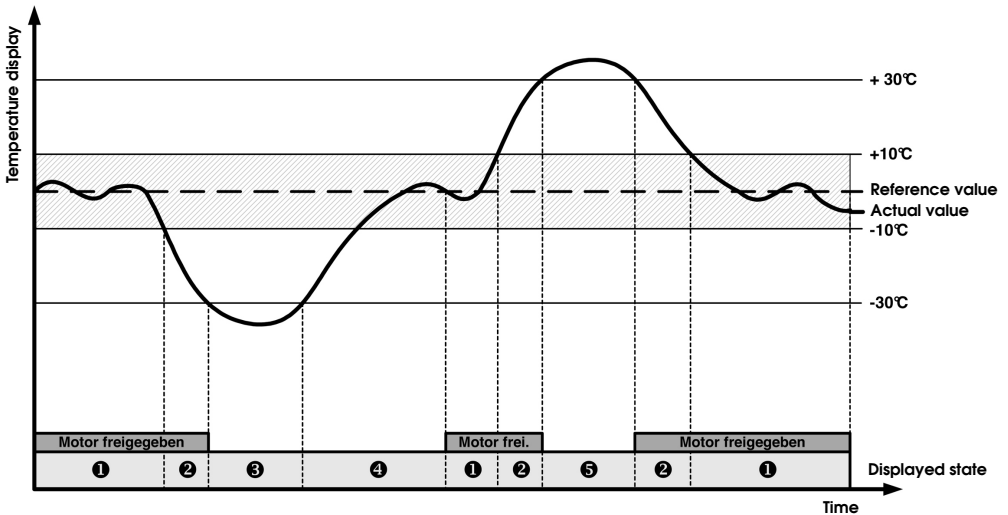
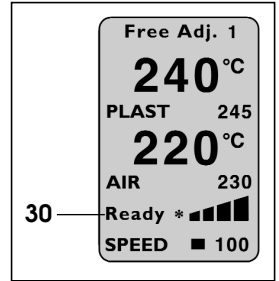

No.	Status display	Status properties
1	Ready*	Ready to weld
2	M enabled	Deviation of the welding parameters > 10°C
3	Heat	Deviation of the welding parameters > -30°C, drive motor disabled
4	220s	Warm-up lock time of 220 sec., drive motor disabled
5	Too hot	Deviation of the welding parameters > +30°C, drive motor disabled

### Starting the welding process

- Fit the appropriate **welding shoe (8)** as required.
- Set the **potentiometer (3)** to max.
- Once the operating temperature is reached («READY\*» status), welding can begin.
- Actuate the **drive on/off switch (2)**.
- Insert a 3 or 4 mm welding rod into the **welding-rod intake (12)**.
- The welding rod is automatically drawn in through the **welding-rod intake (12)**. The welding rod feed must take place without resistance.



#### CAUTION!

**Never insert welding rods into both welding-rod intakes at the same time. Always operate the device with welding rod.**

- Interrupt drive by releasing the **drive on/off switch (2)**.
- Direct the **pre-heating nozzle (9)** towards the welding zone.
- Pre-heat the welding zone with a fanning motion.
- Apply the device to the prepared welding location and actuate the **drive on/off switch (2)** again.
- Perform test welding by following the welding instructions from the material manufacturers and national standards or directives.
- Inspect test welding.
- Adjust the temperature setting and welding output as required.
- For long welding jobs, the **drive on/off switch (2)** can be locked-on with the **drive locking device (4)**.

### Switching off the tool

- Disengage the **drive locking device (4)** and release the drive on/off switch (2). Remove the welding material in the welding shoe so that the welding shoe will not be damaged when starting the next welding run.
- Switch off the heating systems with the Stand-by/Enter button (26).
- Allow the device to cool down for approx 5 minutes.
- Switch off the **main switch (1)**.

## Further settings

### Contrast setting



Given unfavourable lighting conditions and fluctuations in the ambient temperature, the contrast on the display can be set in the operating window with the **back key (25)**.

### Heating on/off



In the case of long interruptions (standby), the heating for PLAST and AIR can be deactivated with the **Stand-by/Enter key (26)** in the operating window.

## Activate key lock

1. Menu



2. Key lock



3. Activate



If the key lock has been activated, key lock appears in the display.

The lock can be reset as follows:

### Deactivate key lock

1. Back



2. Reset



3. Select



Confirmation with the Select key must immediately follow the reset!

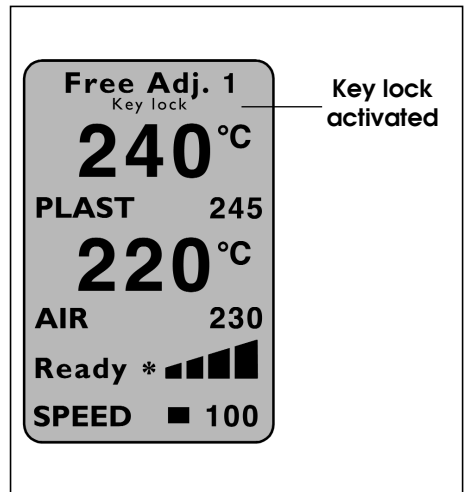

Menu navigation

Menu

Menu



Scroll



Select



Functions

Scroll







Select and return

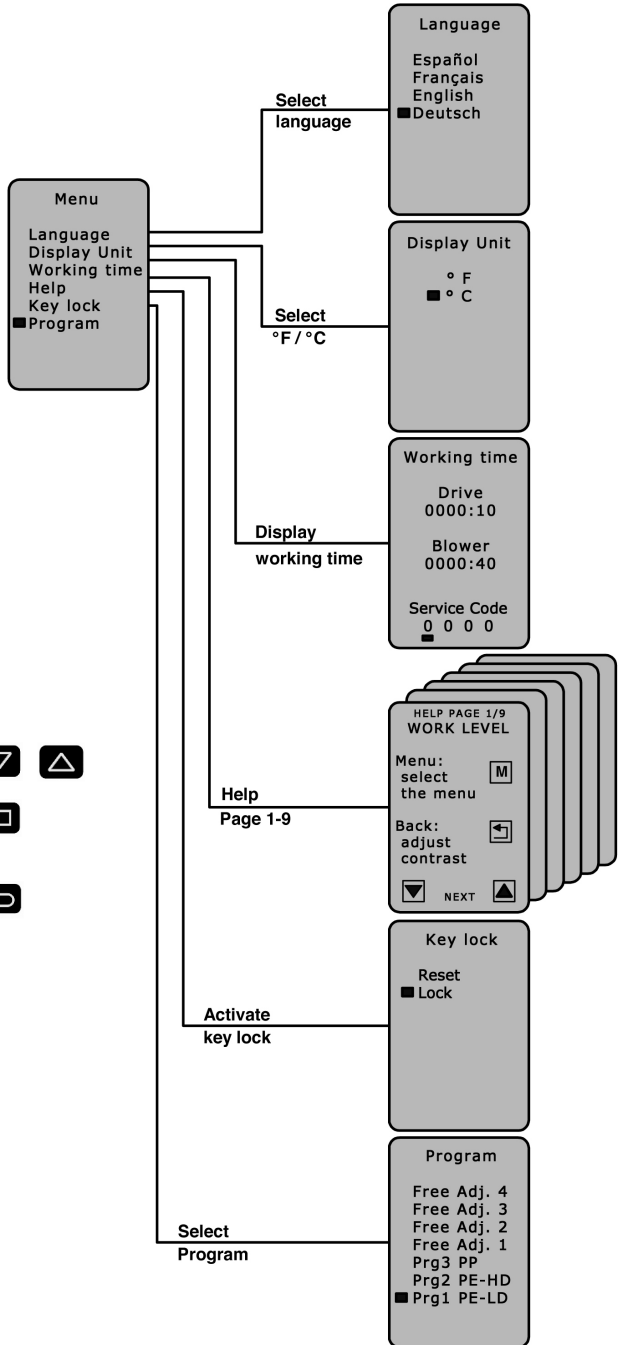

Return to operating window  
Scroll



**Welding parameters – Programming**

- Menu 
- Select program 
- Scroll  
- Enter 

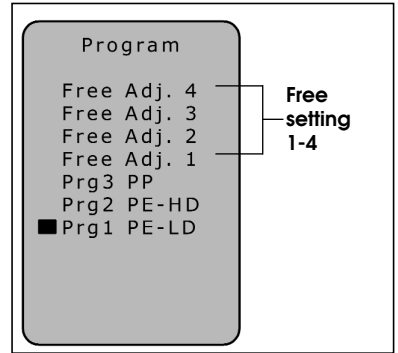

The hand extruder is suitable for the following types of thermoplastic:

- PP/PE-HD/PE-LD

**Programs 1 – 3** include the relevant preset values, which can be adjusted during the course of the welding process. The adjustments are not saved!

The free settings 1 - 4 are factory set and can be freely programmed. The parameters remain saved after the tool is switched off.

Welding program	Soil PLAST (°C)	Soil AIR (°C)
Free settings. 1 – 4	230	260
Prg1 PE-LD	220	260
Prg2 PE-HD	230	260
Prg3 PP	240	260

The **welding program (17)** currently set is shown in the operating display.

**Setting the welding output**

- Place the cursor on the «SPEED» position by pressing the **Select key (28)**.
- Set the welding output value (30 to 100) with the **Up key (29)** or **Down key (27)**.

**Setting the PLAST and AIR temperature**

- Place the cursor on the «PLAST» or «AIR» position by pressing the **Select key (28)**.
- Set temperature value with the **Up key (29)** or **Down key (27)**.

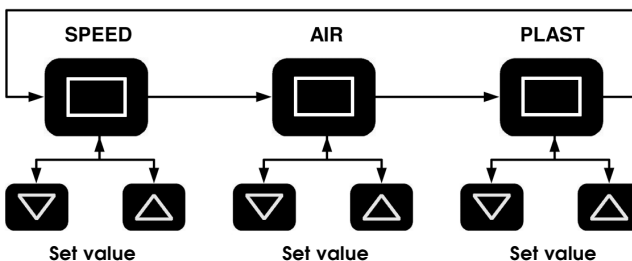

## Replacing the welding shoe

- The welding shoe must only be replaced when the tool has attained its operating temperature.



**Work with temperature resistant gloves only.  
Danger of getting burned!**

### • Dismounting

- Switch off the unit at operating temperature and disconnect from the power supply.
- Remove the **welding shoe (8)** with **welding-shoe holder (34)** by loosening the **clamping screws (35)** from the **extruder nozzle (32)**.
- Each time when changing the welding shoe, clean the **extruder nozzle (32)** from welding-material remainders and ensure that the **extruder nozzle (32)** is screwed tight.
- Remove the **welding shoe (8)** by loosening the **fastening screws (33)** from the **welding-shoe holder (34)**.

### • Assembly

- Mount a **welding shoe (8)** (which is adapted to the welding seam) to the **welding-shoe holder (34)** with the **fastening screws (33)**.
- The **welding shoe (8)** and the **welding-shoe holder (34)** must be firmly tightened with the **clamping screws (35)**.

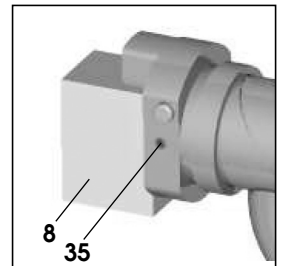
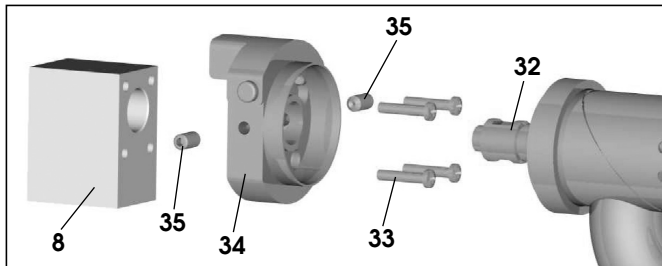

8 Welding shoe  
32 Extruder nozzle  
33 Welding shoe clamping bolts

34 Welding shoe holder  
35 Clamping screw

## Welding direction

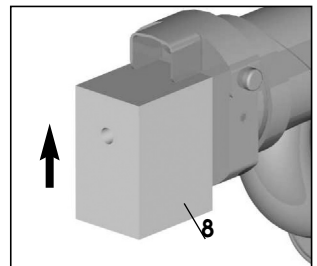
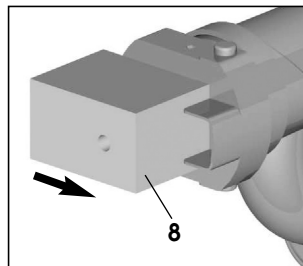
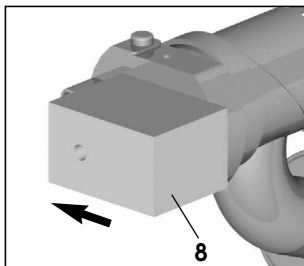

By loosening the **clamping screws (35)**, the **welding shoe (8)** can be variably adjusted (by turning) to the desired welding direction. Afterwards, the **clamping screws (35)** must be firmly retightened

An error occurring is shown in the status display (30) (e.g. **Err04** Motor is overheated).

### Display **ErrXX**

When an error occurs, the heating units for AIR and PLAST, as well as the drive motor, are switched off immediately!

Should this not take place, the tool must be disconnected from the mains supply immediately!

### Further procedure with status display (30) **ErrXX**

- Note down the error code
- Disengage the **drive locking device (4)** and release the **drive on/off switch (2)**.
- Switch off the **main switch (1)**.
- Start using the tool again under supervision and ensure that the extruder is not overheated from the outside.
- Eject the remaining plastic from the screw if possible.
- Should the error reoccur, the tool should be sent to the Service Centre to be checked, specifying the error code.

The following errors are recognised by the tool:

Display	Type of fault
<b>Err01</b>	Overheating of the air or defective temperature probe
<b>Err02</b>	Overheating of the plastic welding material or defective temperature probe
<b>Err04</b>	Overheating of the motor winding, motor is overheated
<b>Err08</b>	Overheating of the heating element, AIR or failure of the blower motor
<b>Err10</b>	Overheating of the electronics
<b>Err40</b>	Short circuit of the PLAST temperature probe

Several errors can occur at once e.g. **Err02** and **Err04** Display: **Err06** !

Further combinations are displayed with the letters A, B, C, D, E and F.

e.g. **Err08** and **Err02** Display **Err0A** !!

### Drive overheating protection

If the drive is overheated by external influences or because the PLAST temperature is too low, the internal temperature protection of the drive switches off (see **Err04**).

### False start protection

The drive motor is secured against automatic starting after errors/malfunctions, e.g., overheating **Err04**. The indication «Switch off drive» appears on the **display (5)**, while the drive motor remains in blocked condition. After correcting the malfunction and switching off the drive (loosen **drive locking device (4)**) and release the **drive on/off switch (2)**, the indication «Switch off drive» in the **display (5)** goes out. Working can now

Only Leister accessories may be used.



Unit stand

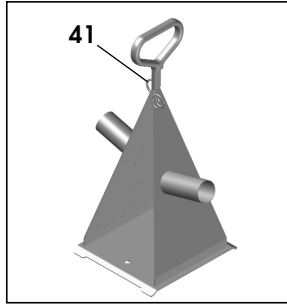

Transportable welding rod dereel holder

- The holder is designed for two welding rod reels with  $\varnothing$  300 mm
- To ensure optimal rod dispensing, the welding rod should be passed through the **eyelets (41)** provided.

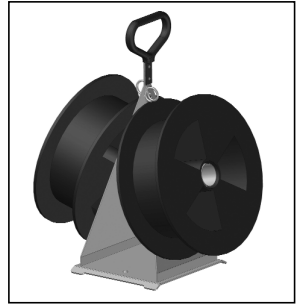

**Welding-shoe assortment WELDPLAST S2 standard**

Leister Process Technologies offers welding shoes for all the common seam geometries in various sizes:

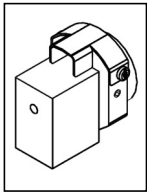

Blank

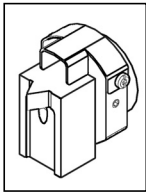

V weld

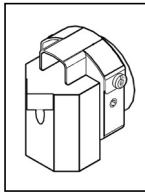

Fillet weld

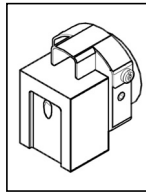

Overlap weld

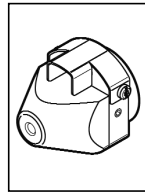

Corner, short

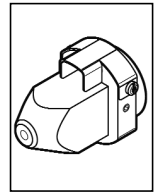

Corner, long

## MAINTENANCE

- Check the **power supply cord (14)** and plug for electrical and mechanical damage.
- Clean the **extruder nozzle (32)** each time the welding shoe is replaced and remove any welding deposits.

## SERVICE AND REPAIR

- Repairs should only be carried out by authorized **Leister Service Centres**. They guarantee a specialised and reliable **Repair Service within 24 hours** using original spare parts in accordance with the circuit diagram and spare parts list.
- If the service message appears with the **Service Code 1** after switching on WELDPLAST S2, the state of the carbon brushes should be checked by an authorised **Leister Service Centre** and the carbon brushes replaced, if necessary.
- The display can be removed with the  **Select key (28)**.
- The hand extruder can be used again for a short time.
- If the carbon brushes are not replaced within a short time, the drive will run until the mechanical brush reaches its limit stop. No more error messages appear on the display, the drive no longer runs.

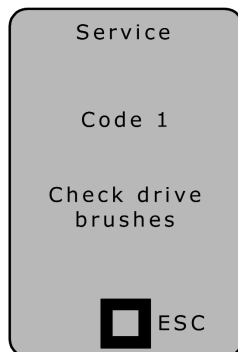

## WARRANTY

- For this tool, we generally provide a warranty of one (1) year from the date of purchase (verified by invoice or delivery document). Damage that has occurred will be corrected by replacement or repair. Heating elements are excluded from this warranty.
- Additional claims shall be excluded, subject to statutory regulations.
- Damage caused by normal wear, overloading or improper handling is excluded from the guarantee.
- Guarantee claims will be rejected for tools that have been altered or changed by the purchaser.

**Technical data and specifications are subject to change without prior notice**

**Your authorized Service Centre is:**